

# **FURUNO**

## **OPERATOR'S MANUAL**

*COLOR SCANNING  
SONAR*

Model **FSV-25/FSV-25S**

---

**ECF**

(Elemental Chlorine Free)

The paper used in this manual  
is elemental chlorine free.

**FURUNO ELECTRIC CO., LTD.**

9-52 Ashihara-cho,  
Nishinomiya, 662-8580, JAPAN

• FURUNO Authorized Distributor/Dealer

All rights reserved. Printed in Japan

Pub. No. OME-13440-E

(REFU ) FSV-25/25S

A : MAY 2014

E : MAR. 10, 2021



0 0 0 1 7 8 7 6 9 1 4

# IMPORTANT NOTICES

---

## General

- This manual has been authored with simplified grammar, to meet the needs of international users.
- The operator of this equipment must read and follow the instructions in this manual. Wrong operation or maintenance can void the warranty or cause injury.
- Do not copy any part of this manual without written permission from FURUNO.
- If this manual is lost or worn, contact your dealer about replacement.
- The contents of this manual and the equipment specifications can change without notice.
- The example screens (or illustrations) shown in this manual can be different from the screens you see on your display. The screens you see depend on your system configuration and equipment settings.
- Save this manual for future reference.
- Any modification of the equipment (including software) by persons not authorized by FURUNO will void the warranty.
- The following concern acts as our importer in Europe, as defined in DECISION No 768/2008/EC.
  - Name: FURUNO EUROPE B.V.
  - Address: Ridderhaven 19B, 2984 BT Ridderkerk, The Netherlands
- The following concern acts as our importer in UK, as defined in SI 2016/1025 as amended SI 2019/470.
  - Name: FURUNO (UK) LTD.
  - Address: West Building Penner Road Havant Hampshire PO9 1QY, U.K.
- All brand, product names, trademarks, registered trademarks, and service marks belong to their respective holders.

## How to discard this product

Discard this product according to local regulations for the disposal of industrial waste. For disposal in the USA, see the homepage of the Electronics Industries Alliance (<http://www.eiae.org/>) for the correct method of disposal.

## How to discard a used battery

Some FURUNO products have a battery(ies). To see if your product has a battery, see the chapter on Maintenance. If a battery is used, tape the + and - terminals of the battery before disposal to prevent fire, heat generation caused by short circuit.

### In the European Union

The crossed-out trash can symbol indicates that all types of batteries must not be discarded in standard trash, or at a trash site. Take the used batteries to a battery collection site according to your national legislation and the Batteries Directive 2006/66/EU.

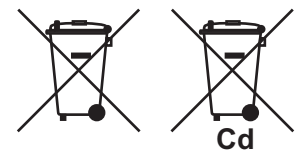

### In the USA

The Mobius loop symbol (three chasing arrows) indicates that Ni-Cd and lead-acid rechargeable batteries must be recycled. Take the used batteries to a battery collection site according to local laws.

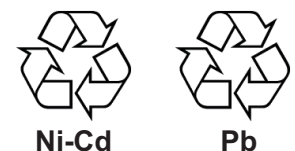

### In the other countries

There are no international standards for the battery recycle symbol. The number of symbols can increase when the other countries make their own recycle symbols in the future.



# SAFETY INSTRUCTIONS

The operator of this equipment must read the safety instructions before attempting to operate the equipment.



## DANGER

Indicates a hazardous situation which, if not avoided, will result in death or serious injury.



## WARNING

Indicates a potentially hazardous situation which, if not avoided, could result in death or serious injury.



## CAUTION

Indicates a potentially hazardous situation which, if not avoided, may result in minor or moderate injury.



Warning, Caution



Prohibitive Action



Mandatory Action



## DANGER



**Keep away from raise/lower shaft in hull unit when the shaft is moving.**  
Gears in hull unit will cause serious injury.



## WARNING



**Immediately turn off the power at the switchboard if water leaks into the equipment or something is dropped into the equipment.**

Continued use of the equipment can cause fire or electrical shock. Contact a FURUNO agent for service.



**Immediately turn off the power at the switchboard if the equipment is emitting smoke or fire.**

Continued use of the equipment can cause fire or electrical shock. Contact a FURUNO agent for service.



**Do not place liquid-filled containers on the equipment.**

Fire or electrical shock can result if something spills into the equipment.



**Turn off the power immediately if water leaks into the equipment or something is dropped into the equipment.**

Fire or electrical shock can result if the power is not turned off.



**Use the correct fuse.**

Fire or bodily injury can result if the wrong fuse is used.



## WARNING



**Do not open the equipment.**  
Only qualified personnel are allowed to work inside the equipment.



**Do not disassemble or modify the equipment.**  
Fire, electrical shock or serious injury can result.



**Do not operate the equipment with wet hands.**  
Electrical shock may result.



**Do not install the equipment where it may be subject to rain or water splash.**  
Fire or electrical shock can result if water leaks in the equipment.

## ⚠ WARNING

**!** Before raising or lowering the transducer manually, make sure the motor brake and drive shaft brake are engaged.

**!** Handle the transducer carefully. Do not swing the transducer or strike it against an object, to prevent damage to the transducer.

**!** Do not transmit the transducer when it is out of water (for example, when dry-docked), to prevent damage to the transducer.

**!** Do not remove the brake on the hull unit, to keep the shaft from falling.

**!** When checking the brake on the hull unit, always take measures against static electricity. Static electricity can cause the unit to move unexpectedly, which can result in personal injury to damage to the unit.

## ⚠ CAUTION

**⊘** Maximum speed while the transducer is projected or being raised or lowered is as below, to prevent damage to the transducer.

Projected length (mm)	Max. speed (kn)	
	Transducer stopped	Raising/Lowering
Less than 1100	20.0	14.5
1100 to 1300	18.0	13.5
Over 1300	16.0	12.0

**!** Replace anti-corrosion zinc plates yearly. Corrosion between the main shaft and transducer may result if not replaced, allowing water leakage and/or loss of transducer.

**!** An LCD is made of glass. Rough handling can break the glass. Handle the LCD carefully to prevent injury.

## WARNING LABELS

Warning labels are attached to the units of the system. Do not remove the labels.

If a label is missing or damaged, contact a FURUNO agent or dealer about replacement.

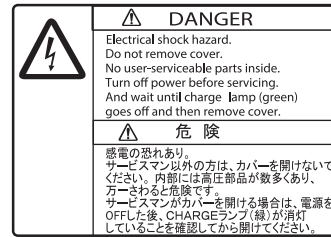

Name: Warning Label  
Type: 10-079-7-6144  
Code No.: 100-310-880-10

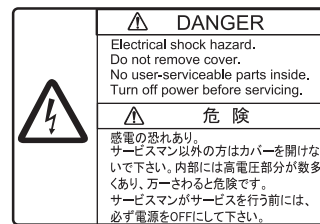

Name: Danger Label  
Type: 10-089-7544-0  
Code No.: 100-394-370-10

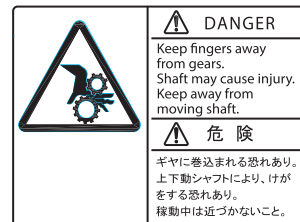

Name: Warning Label  
Type: 10-071-5313  
Code No.: 100-291-160-10

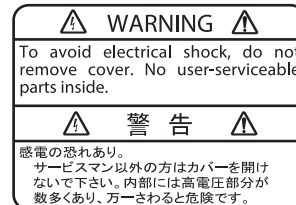

Name: Warning Label (1)  
Type: 86-003-1011-3  
Code No.: 100-236-233-10

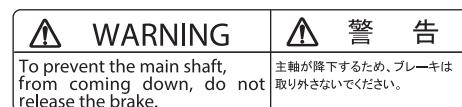

Name: Warning Label  
Type: 10-089-5548-1  
Code No.: 100-386-951-10

# EMERGENCY STOP BUTTON ON HULL UNIT

---

The **EMERGENCY STOP** button on the hull unit stops the raising or lowering of the transducer in case of an emergency. The transducer stops moving when the button is operated, a warning message appears and the transducer cannot be raised or lowered. The transducer is also stopped when the ratchet wrench in the hull unit, which is used to manually raise the transducer, is removed from its holder.

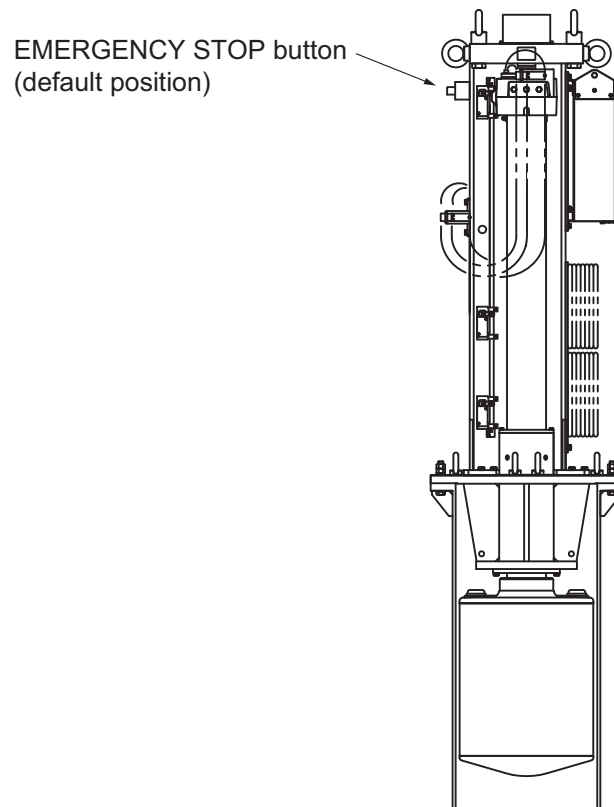

To release the emergency stop condition, first confirm that no one is near the hull unit. Then do the following:

- To release the **EMERGENCY STOP** button, turn the button in the direction of the arrow on the button.
- Return the ratchet wrench to its holder.

# TABLE OF CONTENTS

---

<b>FOREWORD</b> .....	<b>ix</b>
<b>SYSTEM CONFIGURATION</b> .....	<b>xi</b>
<b>1. OPERATIONAL OVERVIEW</b> .....	<b>1-1</b>
1.1 Control Description .....	1-1
1.1.1 Control unit .....	1-1
1.1.2 Sub control unit (option) .....	1-3
1.1.3 Remote controller (option) .....	1-4
1.2 Breaker On/Off .....	1-4
1.3 Turning the Power On/Off.....	1-5
1.4 Lowering, Raising the Transducer.....	1-6
1.4.1 Lowering the transducer .....	1-6
1.4.2 Raising the transducer .....	1-7
1.4.3 How to check how far the transducer is projecting .....	1-7
1.5 Screen Brilliance, Panel Dimmer.....	1-8
1.5.1 Screen brilliance.....	1-8
1.5.2 Panel dimmer .....	1-8
1.6 Display Mode, Display Division .....	1-10
1.6.1 How to select a display mode.....	1-11
1.6.2 Display mode picture examples .....	1-11
1.7 Software Function Key .....	1-13
1.8 How to Adjust the Gain.....	1-13
1.9 How to Use the Menu .....	1-14
<b>2. HORIZONTAL MODE</b> .....	<b>2-1</b>
2.1 Basic Operating Procedure .....	2-1
2.2 Indications and Markers .....	2-2
2.2.1 Horizontal mode, full-screen display .....	2-2
2.2.2 Horizontal2 mode .....	2-3
2.3 Display Range .....	2-4
2.4 Tilt Angle.....	2-4
2.4.1 How to set the tilt angle .....	2-4
2.4.2 Automatic tilt.....	2-5
2.4.3 Relation between bottom echo and tilt angle .....	2-6
2.4.4 Tilt angle for surface fish .....	2-7
2.4.5 Suitable tilt angle .....	2-8
2.5 How to Measure Range and Bearing to a Target.....	2-8
2.6 How to Eliminate Weak Echoes .....	2-9
2.6.1 Change sensitivity of TVG curve .....	2-9
2.6.2 Change near gain, far gain.....	2-10
2.7 How to Adjust Strong, Weak Echoes.....	2-11
2.7.1 AGC Near, AGC Far, AGC Distance.....	2-11
2.7.2 How to shorten pulse length.....	2-12
2.7.3 How to suppress unwanted echoes .....	2-12
2.8 How to Suppress Bottom and Sea Surface Reflections in Shallow Waters .....	2-13
2.9 How to Reject Sonar Interference and Noise .....	2-14
2.9.1 How to identify the noise source .....	2-14
2.9.2 Change TX interval.....	2-14
2.9.3 Interference rejector .....	2-15
2.9.4 Shift TX frequency.....	2-15
2.9.5 Noise limiter.....	2-16
2.9.6 Reverberation.....	2-17

TABLE OF CONTENTS

2.9.7	Echo average .....	2-17
2.9.8	2nd echo rejection .....	2-17
2.10	How to Adjust Beamwidth .....	2-17
2.11	How to Track a School of Fish .....	2-18
2.11.1	How to select the target lock mode .....	2-18
2.11.2	Fish mode .....	2-19
2.11.3	Target mark mode .....	2-20
2.11.4	Target lock menu description .....	2-20
2.12	Presentation Mode .....	2-21
2.12.1	Presentation mode description .....	2-21
2.12.2	How to select a presentation mode .....	2-22
2.13	How to Detect Schools of Fish Aurally .....	2-22
2.13.1	How to set the bearing .....	2-22
2.13.2	How to select the audio sector .....	2-23
2.13.3	Automatic training .....	2-24
2.13.4	Reverberation for audio signal .....	2-24
2.14	Fish Alarm .....	2-24
2.14.1	How to set the fish alarm .....	2-24
2.14.2	How to set the fish alarm level .....	2-26
2.15	How to Relocate a School of Fish .....	2-27
2.16	How to Compare Concentration of School of Fish .....	2-27
2.16.1	How to compare with the fish estimate mark .....	2-27
2.16.2	How to compare with the circle cursor .....	2-29
2.17	How to Measure the Speed of a School of Fish .....	2-30
2.17.1	How to measure the speed of a school of fish .....	2-30
2.17.2	How to delete fish marks .....	2-31
2.18	Event Mark, Own Ship Position Mark .....	2-32
2.18.1	How to enter an event mark .....	2-32
2.18.2	How to enter an own ship position mark .....	2-33
2.18.3	How to erase an event mark, own ship position mark .....	2-33
2.19	Select Mark Window .....	2-33
2.20	Net Course Mark .....	2-34
2.21	Net Behavior .....	2-35
2.22	Other Menu Items .....	2-36
2.22.1	Display Setting menu .....	2-36
2.23	How to Interpret the Horizontal Display .....	2-40
2.23.1	Bottom and school of fish echoes .....	2-40
2.23.2	Unnecessary echoes .....	2-42
<b>3.</b>	<b>VERTICAL MODE .....</b>	<b>3-1</b>
3.1	Basic Operating Procedure .....	3-1
3.2	How the Vertical Mode Works .....	3-2
3.2.1	Overview .....	3-2
3.2.2	How to set the vertical display .....	3-2
3.3	Vertical Indications and Marks .....	3-3
3.3.1	Typical vertical display .....	3-3
3.3.2	Vertical bearing mark, tilt mark .....	3-4
3.3.3	Cursor position reference mark .....	3-5
3.4	Auto Train .....	3-5
3.5	Display Range .....	3-6
3.6	How to Measure the Range, Bearing to a Target .....	3-6
3.7	How to Eliminate Weak Echoes .....	3-7
3.7.1	Change sensitivity of TVG curve .....	3-7
3.7.2	Change near gain, far gain .....	3-8
3.8	How to Adjust Strong, Weak Echoes .....	3-8
3.8.1	AGC Near, AGC Far, AGC Distance .....	3-8



3.8.2	How to shorten pulse length .....	3-9
3.8.3	How to suppress unwanted echoes .....	3-9
3.9	How to Reject Sonar Interference and Noise .....	3-10
3.9.1	How to identify the noise source .....	3-10
3.9.2	Interference rejector .....	3-10
3.9.3	Shift TX frequency .....	3-10
3.9.4	Noise limiter .....	3-11
3.9.5	Reverberation .....	3-12
3.9.6	Echo average .....	3-12
3.10	How to Adjust Beam Width .....	3-12
3.11	Other Menu Items .....	3-13
<b>4.</b>	<b>NUMERIC/GRAPHIC DATA DISPLAY .....</b>	<b>4-1</b>
4.1	Numeric/Graphic Data Display .....	4-1
4.2	Numeric, Graphic Data Description .....	4-2
<b>5.</b>	<b>HOW TO CUSTOMIZE THE SONAR .....</b>	<b>5-1</b>
5.1	User Menu .....	5-1
5.1.1	How to program the user menu .....	5-1
5.1.2	How to remove items from the user menu .....	5-2
5.2	Function Keys (F1 to F10) .....	5-3
5.2.1	How to execute a program .....	5-3
5.2.2	How to program the function keys .....	5-3
5.2.3	How to check function key programs .....	5-4
5.2.4	How to erase programs .....	5-5
5.2.5	How to program the function keys of remote controller .....	5-6
5.3	USER PROG Control .....	5-7
5.3.1	How to select a user program .....	5-7
5.3.2	How to program the USER PROG control .....	5-7
<b>6.</b>	<b>OTHERS MENU .....</b>	<b>6-1</b>
6.1	Erase Marks Menu .....	6-1
6.2	Wheel Setting Menu .....	6-2
6.3	Display Setting Menu .....	6-3
6.4	Alarm & Audio Menu .....	6-5
6.5	Register Menu .....	6-6
6.6	Initial Setting Menu .....	6-7
<b>7.</b>	<b>RECORD/RECALL OPERATION .....</b>	<b>7-1</b>
7.1	How to Specify Where to Save Still Images .....	7-1
7.2	How to Save Still Images .....	7-2
7.3	How to Display Saved Still Images .....	7-4
7.3.1	How to display the latest still image .....	7-4
7.3.2	How to display a still image from the file list .....	7-5
7.4	How to Save Motion Images .....	7-5
7.5	How to Play Back Motion Images .....	7-6
7.6	How to Save Setting Data .....	7-7
7.7	How to Load Saved Data .....	7-8
7.7.1	How to load the setting information .....	7-8
7.7.2	How to replay setting information .....	7-9
7.8	How to Delete Files .....	7-10
<b>8.</b>	<b>MAINTENANCE, TROUBLESHOOTING .....</b>	<b>8-1</b>
8.1	Preventive Maintenance .....	8-1
8.2	Hull Unit Maintenance .....	8-2
8.2.1	How to grease parts .....	8-3

## TABLE OF CONTENTS

8.2.2	How to replace the gasket.....	8-3
8.2.3	How to replace the anti-corrosion zinc plates .....	8-4
8.3	How to Replace Fuses .....	8-5
8.4	Battery on the Mother Board .....	8-5
8.5	How to Clean the Filter.....	8-6
8.6	How to Clean the Trackball in the Control Unit .....	8-6
8.7	Troubleshooting .....	8-7
8.8	Warning Messages .....	8-8
8.9	Error Codes.....	8-10
8.10	Status Messages.....	8-10
8.11	Tests .....	8-11
8.11.1	How to display the Test menu.....	8-11
8.11.2	Operation test.....	8-12
8.11.3	Board test.....	8-13
8.11.4	Panel test .....	8-14
8.11.5	Test pattern .....	8-15
8.11.6	Fan monitor test .....	8-15
8.12	How to Raise the Transducer from the Hull Unit.....	8-16
8.12.1	How to raise the transducer automatically .....	8-16
8.12.2	How to raise the transducer manually.....	8-18
8.13	How to Check the Brake in the Hull Unit.....	8-19
8.13.1	How to check the brake in the raise/lower control box.....	8-19
8.13.2	How to measure the gap in the motor brake .....	8-20
8.13.3	How to measure the gap in the drive shaft gear .....	8-23
<b>APPENDIX 1 MENU TREE .....</b>		<b>AP-1</b>
<b>APPENDIX 2 BRAKE CHECKING.....</b>		<b>AP-6</b>
<b>SPECIFICATIONS .....</b>		<b>SP-1</b>
<b>INDEX.....</b>		<b>IN-1</b>

# FOREWORD

---

## A Word to the Owner of the FSV-25/FSV-25S

Congratulations on your choice of the FURUNO FSV-25/FSV-25S Color Scanning Sonar. We are confident you will see why the FURUNO name has become synonymous with quality and reliability.

Since 1948, FURUNO Electric Company has enjoyed an enviable reputation for quality marine electronics equipment. This dedication to excellence is furthered by our extensive global network of agents and dealers.

This equipment is designed and constructed to meet the rigorous demands of the marine environment. However, no machine can perform its intended function unless operated and maintained properly. Please carefully read and follow the recommended procedures for operation and maintenance.

Thank you for considering and purchasing FURUNO equipment.

## Features

The FSV-25/FSV-25S is a full-circle, multibeam electronic color scanning sonar which detects and displays schools of fish on the monitor of your choice.

The main features of the FSV-25/FSV-25S are

- Menu-driven operation.
- Vivid 32-color echo strength dependent display for improved recognition of bottom, fish school concentration, distribution and volume.
- Dual Display mode
- Schools of fish can be searched from horizontal (range direction), vertical (depth direction) with vertical features.
- Pitching and rolling compensation for stable picture always.
- User programs for one-touch setup of equipment.
- Function keys for direct access to desired menu item.
- Storage and replay of picture and settings.
- Wide variety of display combination modes: horizontal and vertical.
- Various marks and alphanumeric fishing and navigation information for intuitive operation.
- Fish histogram shows signal strength distribution of echo within estimate mark.
- Audio function for monitoring echoes along user-selected area through loudspeaker (option).
- Fish mark estimates fish speed.
- Fish estimate feature to compare the volume of two schools of fish.
- Net course mark shows probable drift of net against tidal current.

## **About this manual**

- This manual describes the functions of the FSV-25 and FSV-25S. The main difference between the two models is the range:
  - FSV-25: 60 m to 5000 m
  - FSV-25S: 60 m to 10000 m
- Unless noted otherwise, "click" means to push the left button.

## **CE declaration**

With regards to CE declarations, please refer to our website ([www.furuno.com](http://www.furuno.com)) for further information about RoHS conformity declarations.

# SYSTEM CONFIGURATION

Standard configuration is shown with solid lines. Dashed lines indicate optional or local supply equipment.

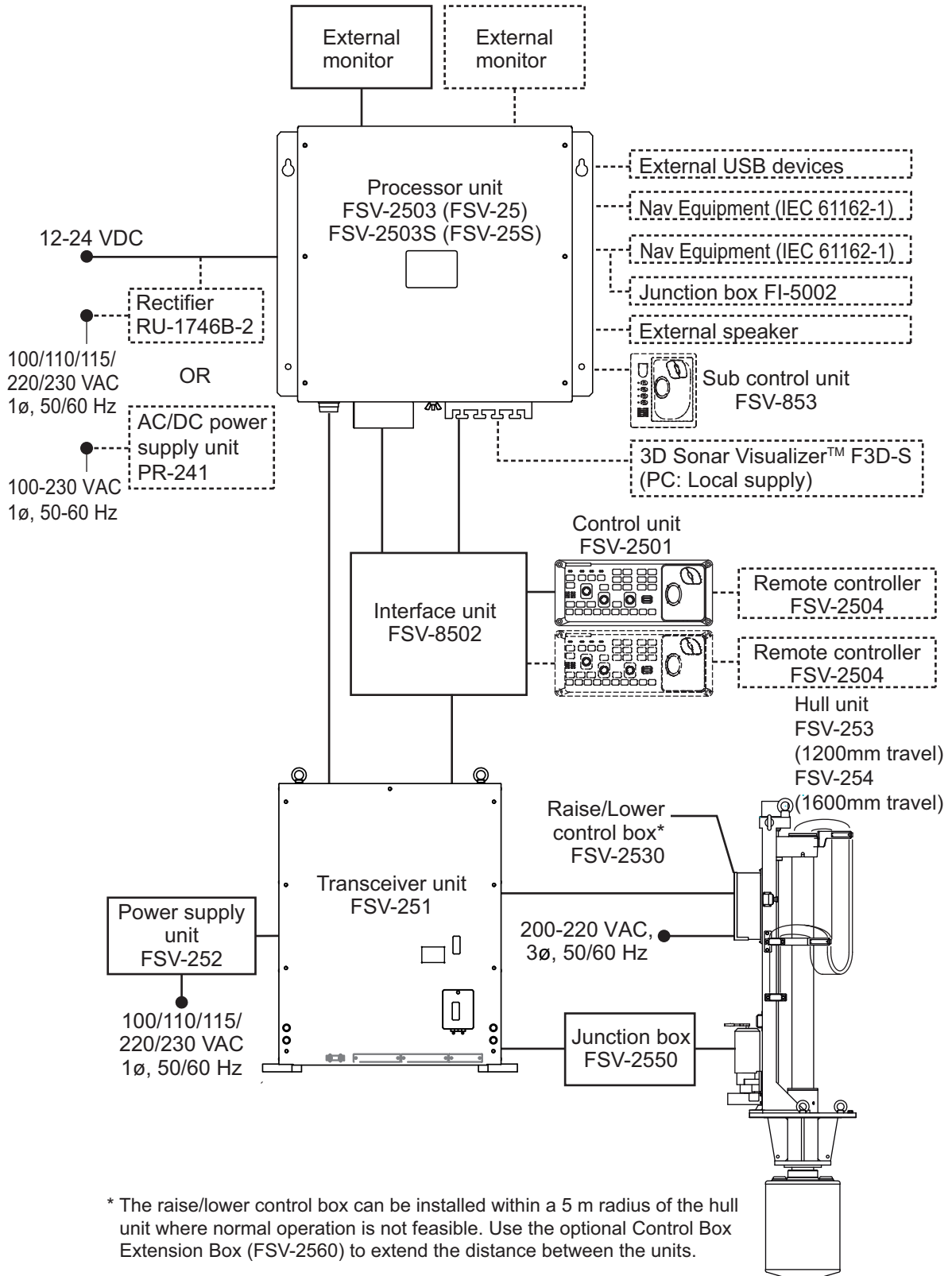

\* The raise/lower control box can be installed within a 5 m radius of the hull unit where normal operation is not feasible. Use the optional Control Box Extension Box (FSV-2560) to extend the distance between the units.

This page is intentionally left blank.

# 1. OPERATIONAL OVERVIEW















## 1.1 Control Description

### 1.1.1 Control unit



Key	Function
	Turns power on.
	Turns power off.
	Raises the transducer.
	<b>If the mid protrusion key is programmed to [Fixed Position]:</b> The transducer goes to the mid protrusion position. <b>If the mid protrusion key is programmed to [Any Position]:</b> The transducer stops at desired position.
	Lowers the transducer (full protrusion).
	Enters the net shooting mark or own ship mark.
	Sets vertical cross section bearing.
	Automatic transducer train width on audio bearing mark (horizontal mode), vertical bearing mark (vertical mode).
	Off centers own ship's position (horizontal mode).
	<ul style="list-style-type: none"> <li>Displays range and bearing marks (horizontal mode).</li> <li>Sets the audio bearing.</li> </ul>
	Deletes trackball-selected mark.

1. OPERATIONAL OVERVIEW

Key	Function
	Enters event mark 1 or own ship mark (horizontal mode).
	Enters event mark 2 or own ship mark (horizontal mode).
	Turns the estimate mark on/off (horizontal mode).
	
	Enters target lock mark (horizontal mode).
	Enters fish mark (horizontal mode).
	<b>Short-push:</b> Opens or closes the menu; returns to the previous menu. <b>Long-push:</b> Closes all menus.
	Sets auto tilt angle.
	Selects display mode.
	<ul style="list-style-type: none"> <li>• Selects the mode tab on the menu.</li> <li>• Selects mode to adjust sensitivity, select range, set tilt, and user program number.</li> </ul>
	Execute assigned program.
	Selects user-programmed settings.
	Adjusts gain for horizontal vertical scans.
	Selects the display range for horizontal and vertical scans.
	Sets transducer tilt angle for horizontal scans.



Key	Function
Trackball unit	<p><b>Trackball:</b></p> <ul style="list-style-type: none"> <li>• Positions cursor.</li> <li>• Selects items, options on menu.</li> </ul> <p><b>Left button:</b><sup>*1</sup></p> <ul style="list-style-type: none"> <li>• <b>Push(short):</b> Confirms the selected item; selects the item to drag and drop<sup>*2</sup>; enters fish mark (default function).<sup>*3</sup></li> <li>• <b>Push(long):</b> Off centers own ship's position (horizontal mode).</li> </ul> <p><b>Scrollwheel:</b></p> <ul style="list-style-type: none"> <li>• <b>Rotate:</b> Sets numeric data; selects menu item; sets tilt angle, range, bearing/train angle, gain, and user program number</li> <li>• <b>Push(short):</b> Confirms the selected item; shows the circle cursor.</li> <li>• <b>Push(long):</b> Shows the [Select Mark] window.</li> </ul> <p><b>Right button:</b><sup>*1</sup></p> <ul style="list-style-type: none"> <li>• <b>Push(short):</b> Shows pop-up menu; confirms the selected item; Enters event mark 1.<sup>*3</sup></li> <li>• <b>Push(long):</b> Cancel the off center.</li> </ul> <p><sup>*1</sup> "Left click", "right click" means "push the left button", "push the right button", respectively.</p> <p><sup>*2</sup> "Drag and drop" means to hold down the left button while dragging the cursor and releasing the button at desired "drop point".</p> <p><sup>*3</sup> The right button or left button can be programmed to enter the marks listed below. Further, those buttons can erase the marks listed below. For details, contact your dealer.</p> <ul style="list-style-type: none"> <li>• Event mark 1, event mark 2</li> <li>• Fish mark</li> <li>• Fish volume mark 1, fish volume mark 2</li> </ul>
Speaker	Sounds buzzer; monitors echoes aurally.

### 1.1.2 Sub control unit (option)

The sub control unit lets you control the sonar from a remote location.

**Note:** Before connecting a sub control unit, turn off the power from the main control unit.

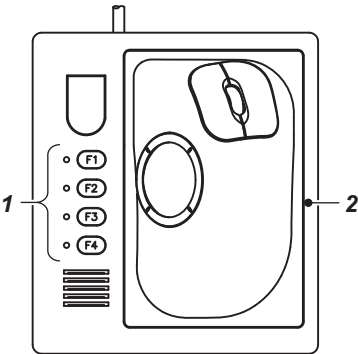
No.	Function (on control unit)	
1	Same as <b>F1, F2, F3</b> and <b>F4</b> key. (The program can be changed. See paragraph 5.2.2.)	
2	Same as trackball unit on control unit.	

### 1.1.3 Remote controller (option)

The remote controller lets you control the sonar from a remote location.

**Note:** Keep the remote controller away from water and water splash. Hook the remote controller to the bracket when it is not in use.

No.	Function (on control unit)
1	Same as F1, F2 and F3 key.
2	Same as ↑, DOWNSTOP, ↓ key.
3	Same as right button.
4	Same as the left button.
5	Same as <b>EVENT</b> , <b>ESTIMATE</b> , <b>TARGET LOCK</b> and <b>FISH</b> keys.
6	Same as trackball.
7	Same as <b>OFF CENTER</b> key.
8	Same as <b>USER PROG</b> control.
9	Same as <b>GAIN</b> control.
10	Same as <b>RANGE</b> control.
11	Same as <b>SHOOT</b> key.
12	Records the current picture.
13	Shows the still image window.
14	Same as <b>DISP MODE</b> key.
15	Same as <b>AUTO TRAIN</b> key.
16	Same as <b>V1/S</b> , <b>V2</b> key.
17	Same as <b>AUTO TILT</b> key.
18	Same as <b>TILT</b> lever.
19	Same as <b>H/V/S</b> key.

The diagram shows a rectangular control panel with a cable connector at the bottom. It features a top row of three function keys (F1, F2, F3) and a power button. Below these are four buttons with directional icons (up, down, left, right). A central trackball is surrounded by four directional arrow buttons. Further down are buttons for 'OFF-CENT', 'USER PROG', and a row of five numbered buttons (1-5). The bottom section contains buttons for 'SHOOT', 'MEMO', 'DISP MODE', 'RECALL', 'AUTO TRAIN', 'V1/S', 'AUTO TILT', 'TILT', and 'H/V/S'.

## 1.2 Breaker On/Off

The power supply unit, transceiver unit and hull unit have a breaker. Turn them on from the switchboard or breaker.



**Note 1:** Turn on the breaker of the power supply unit before turning on the breaker of the transceiver unit. The transceiver unit may be damaged if it is powered first and its tap connection is wrong.

**Note 2:** If the breaker on the hull unit is turned on after the transducer is raised or lowered from the control unit, beware of the moving hull unit.

## 1.3 Turning the Power On/Off



### Turning the power on

Press the POWER ON (I) switch. A beep sounds, and the display changes in the following sequence: FURUNO display → model display → operation test display (see section 8.11.2). Then the lamp above the switch changes as below. The last-used mode is activated in approximately 140 seconds after turning the power on.

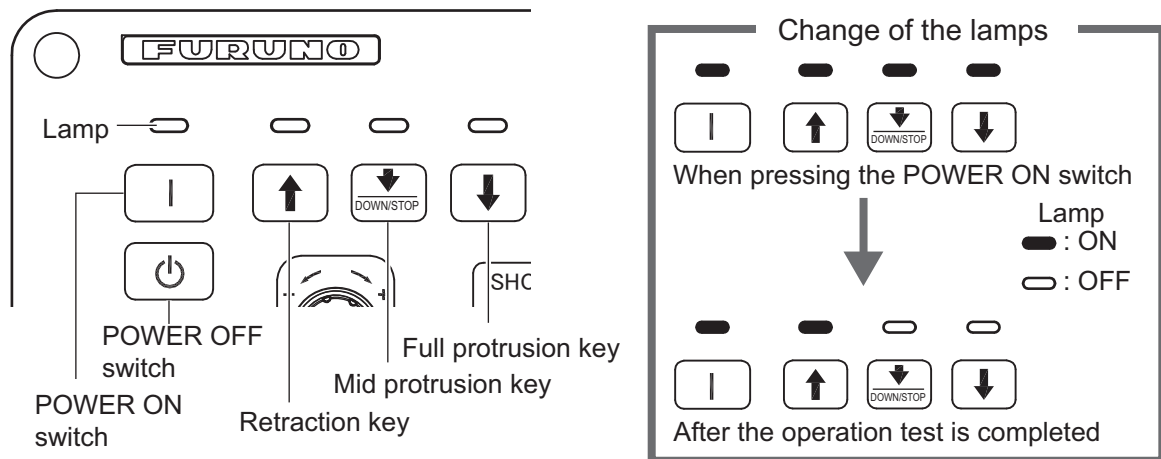

The transducer is not automatically retracted at start up. After applying the power confirm that the transducer is retracted. If the transducer is retracted the lamp above the  key is on steadily. If the power goes off by power failure, etc. use the  key to retract the transducer and then operate the system.





### Turning the power off

1. First retract the transducer with the  key. The lamp above the  key blinks while the transducer is being raised and lights steadily when it is fully raised.
 

**Note:** While raising the transducer, the ship speed must be not exceed the limits posted below, to prevent damage to the transducer and hull unit.

  - projected length not more than 1100 mm: 14.5 kn
  - projected length 1100 mm - 1300 mm: 13.5 kn
  - projected length Over 1300: 12 kn
2. After the  key lights steadily, press the POWER OFF () switch until the screen goes blank.

If the POWER OFF () switch is pressed before retracting the transducer, the message "Raising " (background: red)\* appears and the transducer is retracted. However, for safety purposes, make it a practice to retract the transducer before turning off the power.

\*: Depending on the  key, the background color may be green when raising the transducer.

## 1.4 Lowering, Raising the Transducer



 <b>CAUTION</b>		
<b>Maximum speed while the transducer is projected and being raised or lowered is as below, to prevent damage to the transducer.</b>		
Projected length (mm)	Max. speed (kn)	
	Transducer stopped	Raising/Lowering
Less than 1100	20.0	14.5
1100 to 1300	18.0	13.5
Over 1300	16.0	12.0

 <b>CAUTION</b>
<b>The transducer is stopped whenever the emergency stop button on the hull is operated or the ratchet (for manual raising) is removed from its holder in the hull unit.</b>
A message appears and the transducer cannot be raised or lowered. Re-set the emergency stop button or return the ratchet to its holder to release the emergency stop condition.





### 1.4.1 Lowering the transducer

With the boat at the fishing ground and the power on, press the  key to lower the transducer. The lamp above the key flashes during lowering and the message "Lowering ↓" (background: green) at the center of the screen. When the transducer reaches the water, the message "TX Start" appears. After the transducer is fully lowered the lamp above the key lights. You can see the position of the transducer by watching the transducer mark at the top left corner on the screen. See section 1.4.3.

In normal use, fully lower the transducer. The time required to fully lower the transducer is approx. 12 seconds for full protrusion in case of 1200 mm stroke and 16 seconds in case of 1600 mm stroke.



If the transducer becomes entangled in the net for some reason, partially raise the transducer with the  key. The function of the  key depends the menu setting (main menu → [Others] → [Display Setting] → [Mid Key Setting]).

**[Fixed Position]:** The transducer stops at the selected position. If the  key is operated while the transducer is being raised or lowered, the transducer stops at the fixed position. The fixed position can be set by clicking the transducer position marker. See the next page.

**[Any Position]:** The transducer starts lowering when the  key is operated. The lowering is stopped when the  key is operated. To raise or lower the transducer from the current position, use the  or  key. The  key does not control lowering or raising of the transducer.

You can see the approximate position of the transducer with the transducer position marker (see section 1.4.3). When the transducer is stopped before it reaches full protrusion, the lamp above the  key lights.

## 1.4.2 Raising the transducer

Press the  key to raise the transducer. The lamp above the switch flashes and the message "Raising ↑" (background: green)\* appears. while the transducer is being raised. When the transducer is above the sea surface the, transmission is stopped the message "TX STOPPED" appears for three seconds. When the transducer is completely retracted, the message "RETRACTED" appears and the lamp above the  key lights steadily.

\*: Depending on the POWER OFF () switch, the background color may be red when raising the transducer.

**Note:** If the transducer is not raised within approx. 20 seconds (1200 stroke) or 25 seconds (1600 mm stroke) the message "TRANSDUCER NOT RETRACTED" appears. If this occurs, see section 8.12.2 for how to retract the transducer manually.

## 1.4.3 How to check how far the transducer is projecting

The Transducer Position Mark, which appears at the top left corner, lets you check how far the transducer is projecting. You can show or hide the marker by doing the following operation: [Menu] → [Initial Settings] → (Change confirmation window) → [Mark Display] → [TD Position Mark].

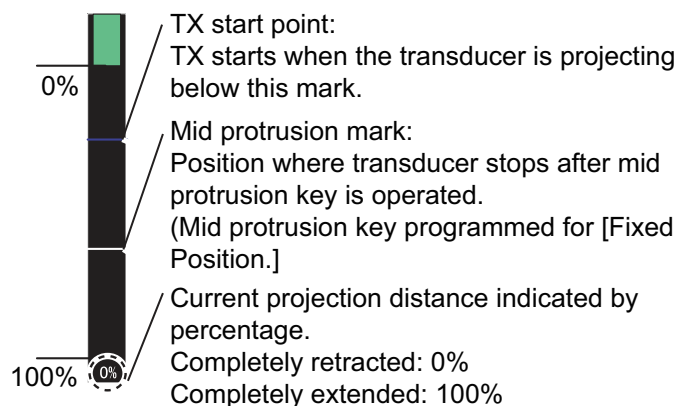

### Notes

The color of the indicator changes according to transducer position and operation state.

- Green: The transducer is fully retracted.
- Brown-yellow: Transducer stopped at position other than "retracted".
- Red: The transducer is being raised or lowered.

If the transducer position cannot be detected the transducer mark flashes. Further, the bar is not displayed, and the amount of projection is indicated as "\*\*\*%".

**How to set mid position**

With [Mid Key Setting] in the [Others] menu set to [Fixed Position], click the transducer position mark to show the window shown in the right figure. Click ▲ or ▼ to change the setting. Click Quit to close the window.

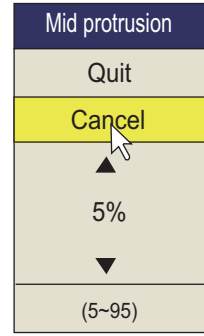

## 1.5 Screen Brilliance, Panel Dimmer

### 1.5.1 Screen brilliance

The brilliance of an external monitor can not be adjusted from the control unit. Use the associated control on the monitor.

### 1.5.2 Panel dimmer

1. Press the **MENU/ESC** key to open the main menu.

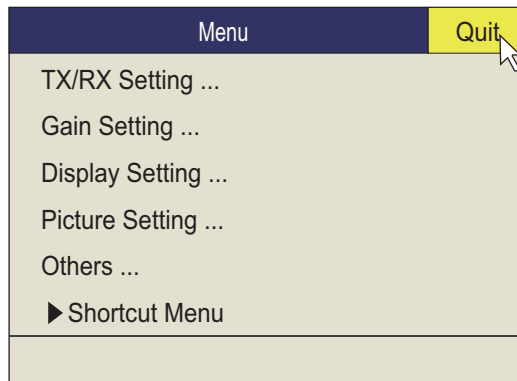

2. Roll the trackball to select [Others] then push the left button.

**Note:** Hereafter, the use of the trackball and the left button are only implied. For example, the sentence in step 2 would be written as “Click [Others]”.

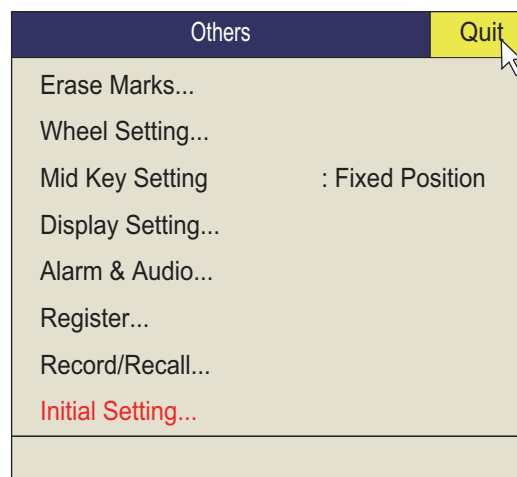

3. Click [Display Setting].

Display Setting		Quit
Mode Selection	: Mode Key	
Echo Display Area	: Within Range	
H2 Display	: Landscape	
2nd Monitor Setting	: Portrait	
V-Scan Aspect Ratio	: Fixed	
V-Scan Dpt Rng	: 100	
Presentation Mode	: Head Up	
TM Disp Range	: 1.6R	
Full Screen Area	: 1.6R	
Tilt lever	: Tilt	
F10 Gain Knob Setting	: Execute	
Gain Control Step	: 0.5	
Auto Tilt	: Narrow	
F9 Net Course Mark	: Execute	
Dimmer	: 7	
Key Beep Volume	: 5	
Timer Display	: OFF	
Circle Cursor Diameter	: 200m	

4. Click [Dimmer] to show the setting box.

Quit
Cancel
▲
7
▼
(0~7)

- 5. Click ▲ (increase) or ▼ (decrease) to select a value.
- 6. Click [Quit] on the setting box to close the box.
- 7. Long-push the **MENU/ESC** key to close all menus.

## 1.6 Display Mode, Display Division

There are four display modes; Horizontal, Horizontal1 + Horizontal2\*, Vertical1\*, and Vertical 1 + Vertical 2\*.

\*: If the FSV-25/FSV-25S is fitted with dual monitors, you can select how the picture data is shown on two displays; Dual Display or Sub Display. For details, see page 6-3.

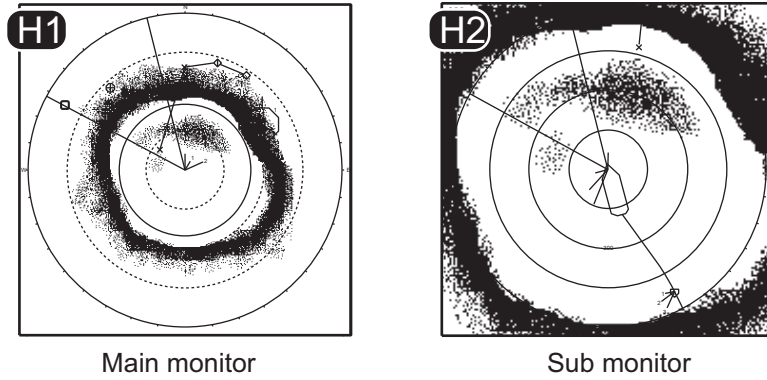

*Ex; Dual Display (H1 + H2 mode)*

### Display format

As shown in the illustration below, you have two choices with which to show the echo display. See page 6-6 for how to select the display method. For the numeric/graphic data display, see chapter 4.

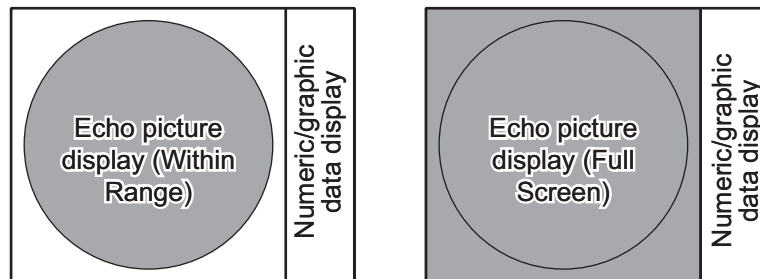



### 1.6.1 How to select a display mode

Press the **MODE** key several times until the desired display appears. The default modes are Horizontal, Horizontal1 + Horizontal2, Vertical1, and Vertical1 + Vertical2. You can program the **MODE** key to show any or all of the modes mentioned above. For further details, see page 6-6.

The **MODE** key may be programmed to show a pull-down menu instead of a conventional menu.

1. Push the right button on the numeric/graphic data display.

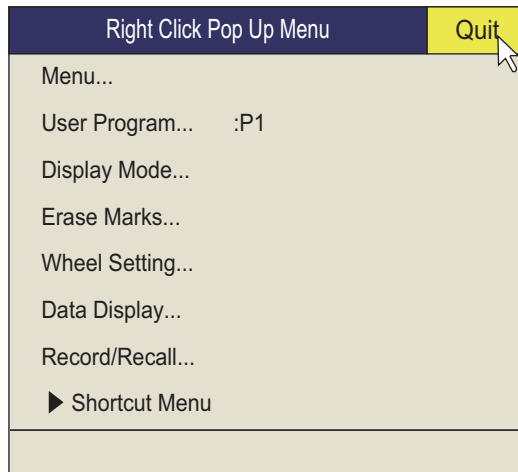

2. Click [Display Mode].

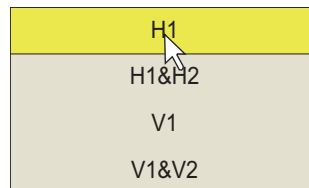

3. Click the mode to use.

### 1.6.2 Display mode picture examples

Below are typical pictures. For sake of brevity, indications and marks are not shown.

#### Horizontal mode

This mode provides 360-degree coverage around the vessel and it is useful for general search. For further details, see chapter 2.

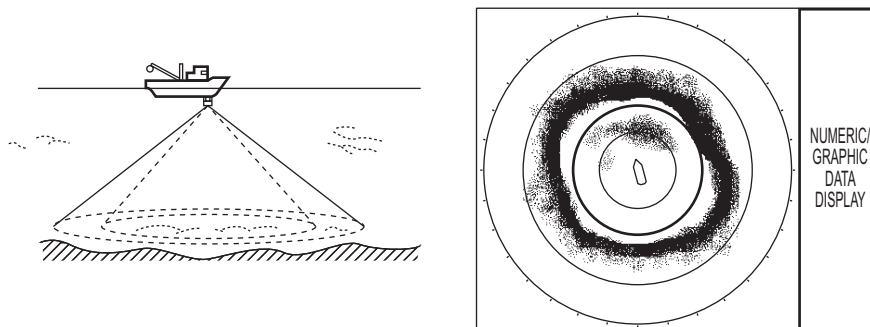

*Horizontal mode*

# 1. OPERATIONAL OVERVIEW

## H2 mode

This mode provides two horizontal screens (H1 and H2) in one of the configurations shown below. The default configuration, Landscape, shows two horizontal displays, one up and one down. Other configurations available are as shown below. Desired configuration may be selected on [H2 Display] in the [Display Setting] menu. For further details, see chapter 2.

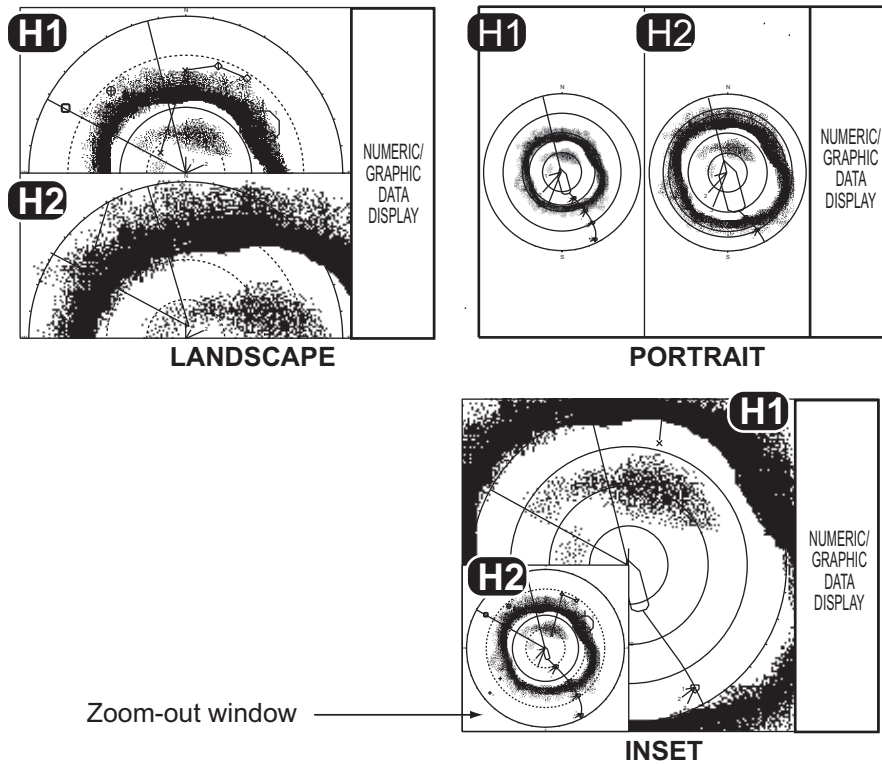

*H2 mode*

## V1 and V2 modes

The V1 and V2 modes show a vertical slice of the bearing selected by the vertical bearing mark on the horizontal display. The vertical 2 mode provides two vertical slices. For further details, see chapter 3.

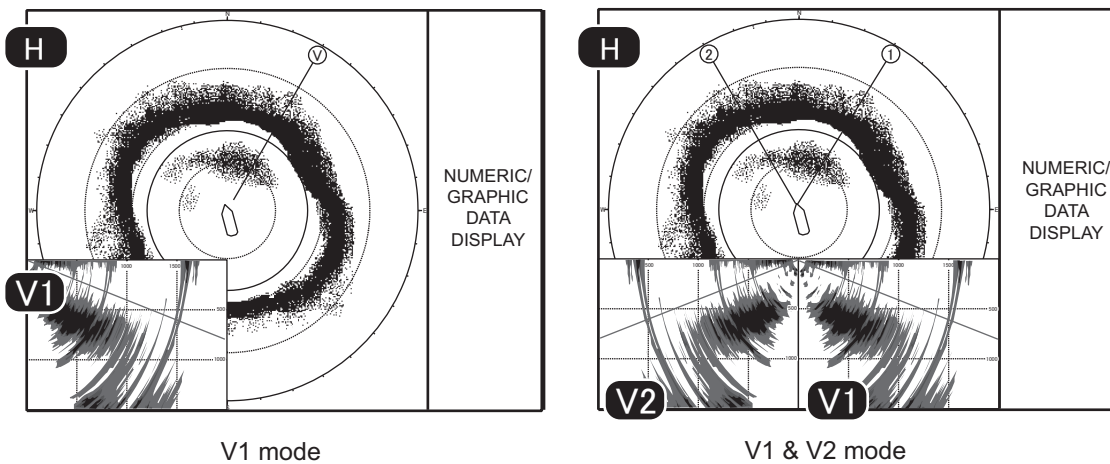

*Vertical mode*

## 1.7 Software Function Key

You can see the current setting for each software function key. Put the cursor at the bottom of the screen for approx. two seconds to show the settings. Left click a function to get the corresponding action. See paragraph 5.2.2.

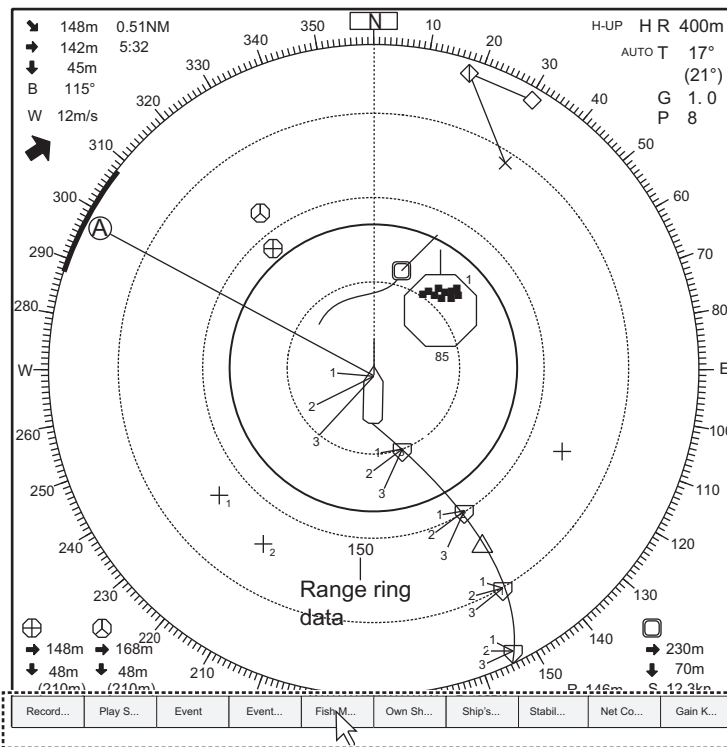

Software function key

You can do the functions assigned to function keys F1-10 (from left).

## 1.8 How to Adjust the Gain

The **GAIN** control adjusts receiver gain (sensitivity) for the horizontal and vertical modes. Adjust it so fish echoes are clearly displayed with minimal noise on the screen. Too high a gain setting not only displays excess noise and makes it difficult to discriminate wanted echoes but also causes bottom echoes to be painted in strong colors, resulting in echoes being masked by bottom reflections. Normally, set the control somewhere between positions 3 and 7.

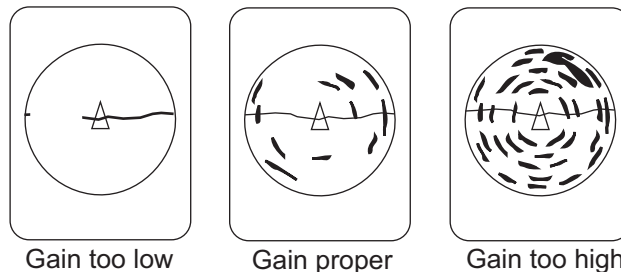

1. If the horizontal and vertical modes are active, press the **H/V/S** key to show the range and gain indications of the mode you wish to adjust. Pressing the **H/V/S** key changes the color of the range and gain indications to orange.
  - H1/H2: Horizontal1 or horizontal2
  - V1/V2: H or V display

## 1. OPERATIONAL OVERVIEW

### 2. Adjust the **GAIN** control.

New gain setting is momentarily displayed in large characters at the top of each display. The setting value is always displayed next to "G". (For the vertical display, the gain indication is shown at the bottom of the display.)

**Note 1:** The gain can also be adjusted from the gain indication. Put the cursor on the gain indication to highlight it in yellow then roll the scrollwheel.

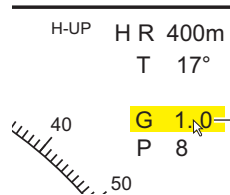

Put the cursor on the gain setting, which is then highlighted in yellow. Spin the scrollwheel to change the setting.

**Note 2:** The default function of the F10 key is [Gain Knob Setting], which adjusts the gain. See page 6-4.

## 1.9 How to Use the Menu

Most operations are carried out from the menu. This section provides basic menu operating information.

### 1. Press the **MENU/ESC** key to open the main menu.

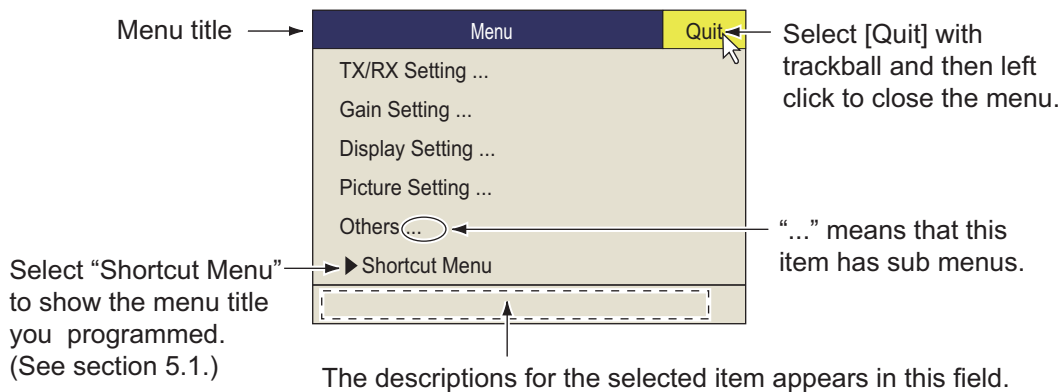

**Note:** You can also show the main menu by pushing the right button to show the pop-up menu. See page 1-16.

### 2. Operate the trackball to place the arrow cursor (↔) on the item you want to select. The yellow cursor marks the current selection. You can also use the scrollwheel to select a menu item.

- Push the left button, or if you selected an item with the scrollwheel push the scrollwheel. If, for example, you selected [TX/RX Setting] at step 2, the following menu appears.

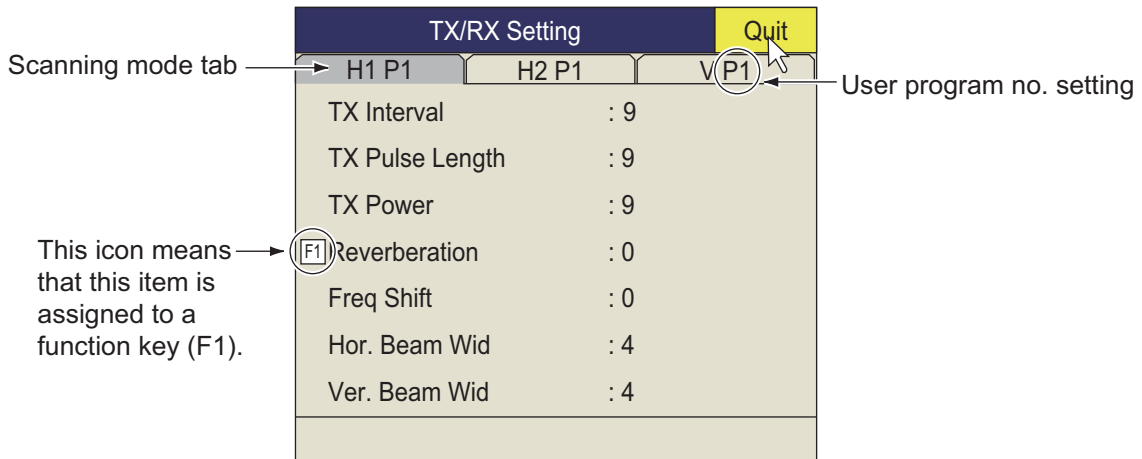

- Press the **H/V/S** key to select the display mode.
  - H1, H2 tab: Items for horizontal display setting
  - V tab: Items for the vertical display setting
 Items which you can not set are shown in gray.
- Click the item to use.

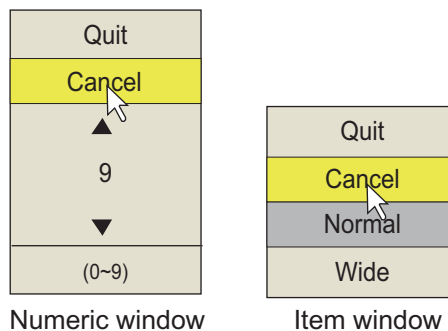

- Select the setting.
  - (Numeric) Click ▲ to increase the value (or roll the scrollwheel upward). To decrease the value, click ▼ (or roll the cursor scrollwheel downward).
  - (Items) Click the item to use.
- Click [Quit] on the setting box to close the box. If you want to cancel the setting, click [Cancel].
- Long-push the **MENU/ESC** key to close all menus.  
You can also close all menus by selecting [Quit] on the active menu and long-pushing the left button.

You can relocate menu windows. Use the trackball to put the arrow cursor on the menu title (blue when menu is active), push the left button, drag the window to new location then release the left button. The position of the menu windows is saved.

**Note 1:** You can move the menu to a desired location by drag and drop. Left click the title bar of the active menu then drag and drop to desired location. The location is stored in memory.

**Note 2:** In the default setting, the sub menu item [Initial Setting] in the [Others] menu and some items in the [Initialization] menu are shown in red. This means these items

## 1. OPERATIONAL OVERVIEW

are locked to prevent accidental change of setting. When you open one of these sub menus and select an item, the confirmation message shown below appears. To change the setting of the selected item, click [Changeable] to show the dialog box for the item. To escape, click [Cancel].

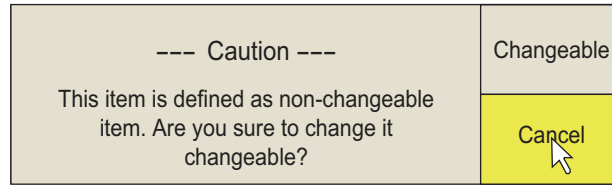

If you do not want to show the confirmation message above, see page 6-16.

**Note 3:** If two menu items are functionally related, the setting of one menu item may cause restriction to another menu item. In this case, the equipment ignores both settings to use different ones or invalidates the setting of the item encountering restriction. The invalid setting value or menu item is shown in gray.

### **Pop-up menu operation**

Push the right button on the numeric/graphic data display to show the pop-up menu. These items can also be accessed from the main menu.

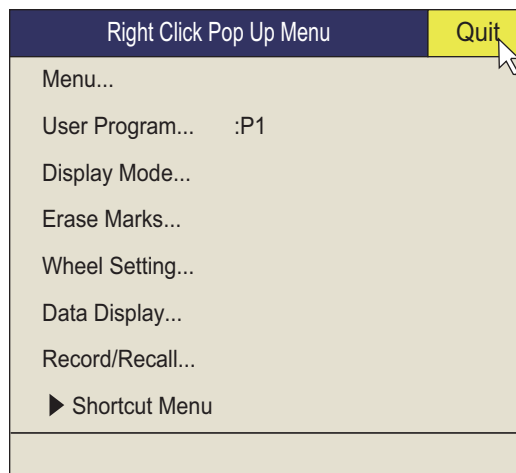

# 2. HORIZONTAL MODE

## 2.1 Basic Operating Procedure



*Control unit*

## 2.2 Indications and Markers

### 2.2.1 Horizontal mode, full-screen display

The full-screen horizontal display provides a 360° picture around the boat. To display the full-screen horizontal picture, press the **DISP MODE** key.

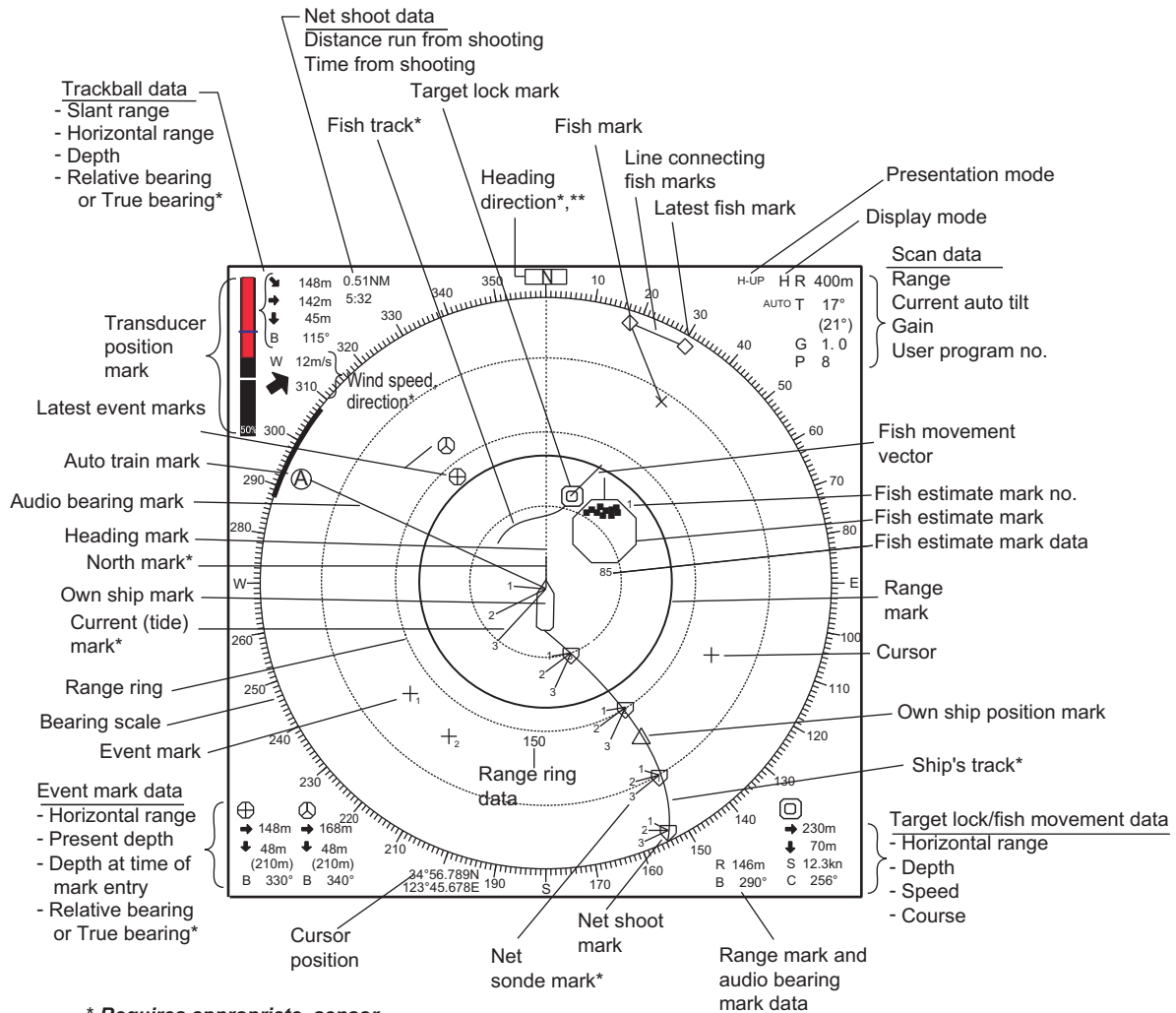

\* Requires appropriate sensor.  
\*\* Appears with head-up mode.

**Note 1:** When the settings listed below are changed, the setting value is shown at the top of the display for five seconds.

- Gain (See section 1.8.)
- Tilt angle (See section 2.4.)
- Automatic training (See section 2.13.3.)
- Display range (See section 2.3.)
- Automatic tilt (See section 2.4.2.)
- User program (See section 5.3.1.)

**Note 2:** The color of the event mark, fish mark, and fish estimate mark can be changed on the menu: main menu → [Others] → [Initial Setting] → (Change confirmation window) → [Mark Display] → [Mark Color].



## 2.2.2 Horizontal2 mode

The H2 mode shows one of three kinds of horizontal display combinations: Landscape, Portrait or Inset as shown on page 1-12. Follow the procedure shown below to select a combination display. The zoom-out display (shown on the inset mode) can be moved by drag and drop operation and its size changed from the menu. To show the horizontal2 mode display, press the **MODE** key and select [H2].

1. Press the **MENU/ESC** key to show the main menu.
2. Click [Others].
3. Click [Display Setting].

Display Setting		Quit
Mode Selection	: Mode Key	
Echo Display Area	: Within Range	
H2 Display	: Landscape	
2nd Monitor Setting	: Portrait	
V-Scan Aspect Ratio	: Fixed	
V-Scan Dpt Rng	: 100	
Presentation Mode	: Head Up	
TM Disp Range	: 1.6R	
Full Screen Area	: 1.6R	
Tilt lever	: Tilt	
<span>F10</span> Gain Knob Setting	: Execute	
Gain Control Step	: 0.5	
Auto Tilt	: Narrow	
<span>F9</span> Net Course Mark	: Execute	
Dimmer	: 7	
Key Beep Volume	: 5	
Timer Display	: OFF	
Circle Cursor Diameter	: 200m	

4. Click [H2 Display].

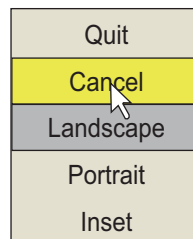

5. Click the desired option.
6. Click [Quit] on the setting box to close the box.
7. Long-push the **MENU/ESC** key to close all menus.

**Note:** Range, tilt angle, gain and program keys can be adjusted separately for each horizontal display.

## 2.3 Display Range

The **RANGE** control selects the detection range and eight ranges are preset at the factory. The range selected is momentarily displayed in large characters at the top of the screen. Range is always displayed next to “R” at the top right corner of the screen.

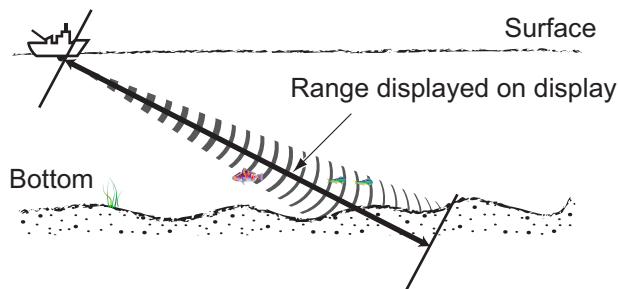

*Default settings for the display range (unit: m)*

Range No.	1	2	3	4	5	6	7	8
Detection range	200	400	600	1000	1600	2000	3000	4000

**Note:** Ranges can be preset at the [H-Scan Range] on the [Others] - [Register] menu. See page 6-6.

1. If the vertical display is active, press the **H/V/S** key to select the horizontal display. If the two horizontal displays are active, press the **H/V/S** key to select H1 or H2 to change the range. The range and gain indications of the horizontal mode must be in orange to change the range (and gain).
2. Operate the **RANGE** control to select a range.

**Note 1:** The range can also be adjusted from the range indication. Put the cursor on the range indication to highlight it in yellow then roll the scrollwheel.

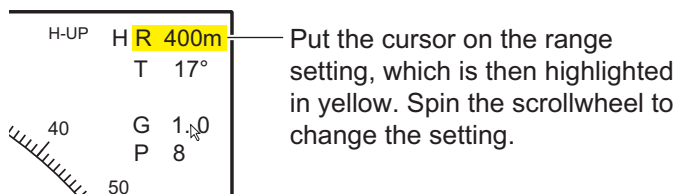

Put the cursor on the range setting, which is then highlighted in yellow. Spin the scrollwheel to change the setting.

**Note 2:** In the target lock function, the range is automatically changed according to target position if [Tilt Interlock] on the [Target Lock] menu is selected to [Tilt & Range].

## 2.4 Tilt Angle

The tilt angle shows the direction to which the sound wave is emitted. When the sound wave is emitted horizontally, the tilt angle is said to be 0° and when vertically, 90°. The tilt angle can be set between -5° (upward) to 60° (downward), in increments of 1°. The tilt angles for horizontal 1 and horizontal 2 modes can be set independently of one another.

### 2.4.1 How to set the tilt angle

To set a tilt angle manually, operate the **TILT** control. Watch the tilt angle indication and tilt angle indicator at the top right corner of the screen. The tilt angle is shown next to “T” at the top right corner of the screen.

Select tilt angle depending on target fish. For surface fish select a shallow angle (about 5°) and for bottom fish, a deep angle.

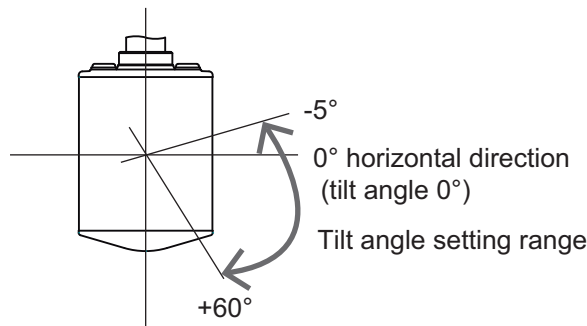

**Note 1:** In the factory default condition, the tilt angle can also be adjusted by rolling the scrollwheel. For the H2 display, move the cursor into the display where you want to change the setting.

**Note 2:** The tilt angle can also be adjusted from the tilt angle indication. Put the cursor on the tilt angle indication to highlight it in yellow then roll the scrollwheel.

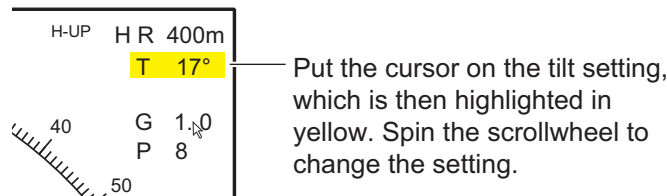

**Note 3:** The **TILT** control functions as a bearing setting lever when the following conditions are met: [Tilt Lever] in the [Display Setting] menu is selected to [Tilt & V1], and the vertical display is chosen in the vertical mode.

### 2.4.2 Automatic tilt

The **AUTO TILT** key automatically scans the tilt angle within the selected width. This is useful when you want to find the center depth of a school of fish. Wide tilt angle is activated from the [Auto Tilt] on the [Others] - [Display Setting] menu.

1. Press the **AUTO TILT** key to select auto tilt angle desired. Each time the key is pressed the auto tilt angle changes in the following sequence.

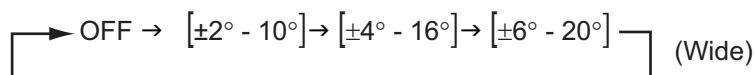
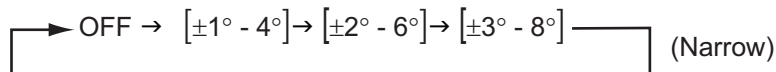

2. If necessary, operate the **TILT** control to change center tilt angle. In automatic tilt, "AUTO" is displayed at the top right corner. To disable automatic tilt, select OFF at step 1.

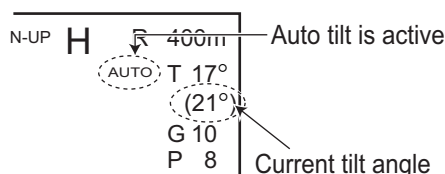

## 2. HORIZONTAL MODE

### *Automatic tilt angle (narrow) with **AUTO TILT** key*

Range (m)	Width 1	Width2	Width3	Period
60, 100	±4°*	±6°*	±8°*	Period: One transmission <b>Note:</b> Tilt angle changes in 2° increments for asterisk-marked width; 1° increments for all other widths.
150, 200	±2°	±4°	±6°*	
300, 400	±1°	±2°	±4°*	
500, 600	±1°	±2°	±3°	
800	±1°	±2°	±3°	
1000	±1°	±2°	±3°	
Over 1200	±1°	±2°	±3°	

### *Automatic tilt angle (wide) with **AUTO TILT** key*

Range (m)	Width 1	Width2	Width3	Period
60, 100, 150	±10°	±16°	±20°	Period: One transmission
200	±10°	±16°	±20°	
300, 400	±10°	±16°	±20°	
500, 600	±8°	±16°	±20°	
800	±6°	±12°	±16°	
1000	±4°	±8°	±12°	
Over 1200	±2°	±4°	±6°	

For example, when the **RANGE** control, **TILT** control and **AUTO TILT** key are set to 800 m, 8° and width (1) respectively, the tilt angle changes at each transmission as follows: 8° → 9° → 8° → 7° → 8°.

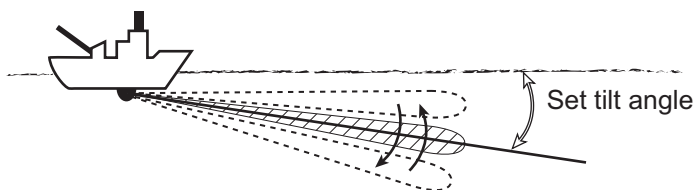

**Note 1:** The **AUTO TILT** key is inoperative when the target lock function is active or is made active. Auto tilt is available when the target lock is OFF.

**Note 2:** If the picture set with auto tilt is not visible, disable auto tilt and try again.

### 2.4.3 Relation between bottom echo and tilt angle

The figure below illustrates how two schools of fish "a" and "b" are displayed on the screen using three different tilt angles.

**Case 1: Tilt angle 30° to 40°:** This tilt angle will display the entire bottom since it is captured by the full width of the beam. The school of fish is obscured by the bottom.

**Case 2: Tilt angle 10° to 20°:** This tilt angle will only display half the bottom since it is captured by only the lower half of the beam. The school of fish is located above the bottom.

**Case 3: Tilt angle 0° to 5°:** This tilt angle may or may not capture the bottom since the returning bottom echo is weak. The school of fish is located close to the bottom.

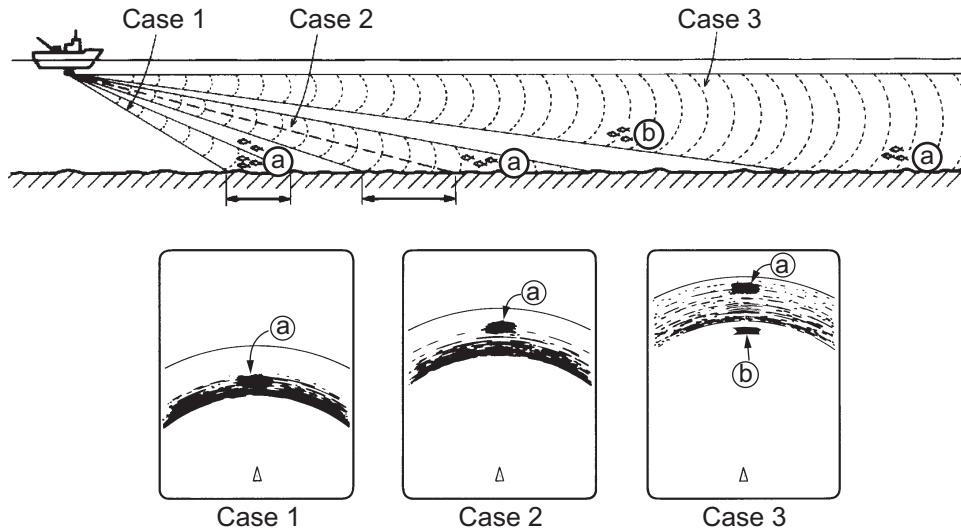

### Points to consider

- Normally, a vertically distributed school of fish is a better sonar target than the bottom, because it reflects the transmitted pulse back toward the transducer.
- In case 3, both schools of fish "a" and "b" are presented. Generally speaking, however, midwater schools of fish tend to be larger than schools of fish on the bottom and they are often displayed near the bottom on the display.
- It is difficult to detect bottom fish when they are not distributed vertically.

## 2.4.4 Tilt angle for surface fish

The sound emitted from the sonar transducer forms a beam with a width of approximately  $10^\circ$  in the vertical direction (vertical beam width at  $-6$  dB). The tilt angle indicates the angle between the centerline of the beam and the horizontal plane. Then, if the tilt angle is set to  $0^\circ$ , the centerline is parallel with the sea surface and one half of the emitted sound goes upward, toward the sea surface.

This causes one half of the emitted sound to be reflected toward the transducer and displayed on the screen as sea surface reflections. When the sea is calm, since the sound is reflected just like a light hitting a mirror at a low incident angle, it propagates away and the sea surface reflections become negligible.

However if the sea is not calm enough, they will become dominant and interfere with observation of wanted echoes. To minimize these sea surface reflections and to search for schools of fish on the surface effectively, the tilt angle is usually set between  $4^\circ$  and  $5^\circ$  so the upper portion of the beam becomes almost parallel with the sea surface. When the sea is rough, the tilt angle is slightly increased to lessen the affect of sea surface reflections.

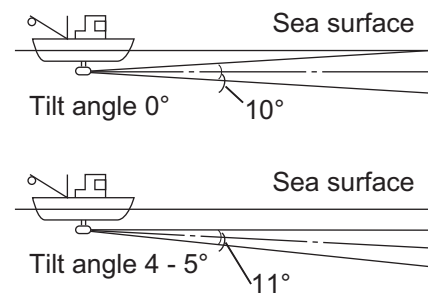

2. HORIZONTAL MODE

2.4.5 Suitable tilt angle

The figure below illustrates the relationship among tilt angle, depth and detection range. Refer to it to find out the suitable tilt angle for a given depth/detection range.

Tilt angle setting: relationship between tilt angle and detection range

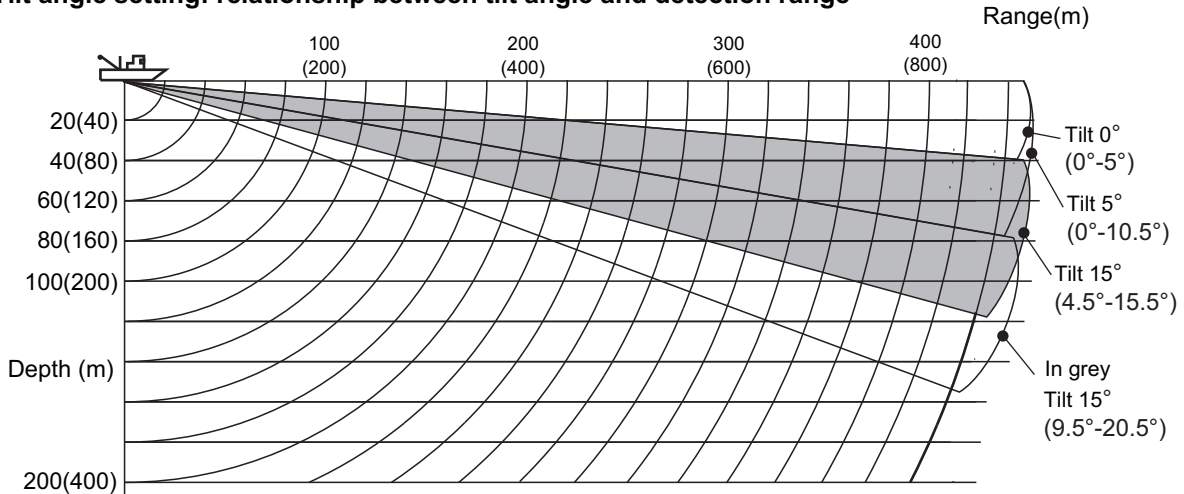

Vertical width of sonar beam

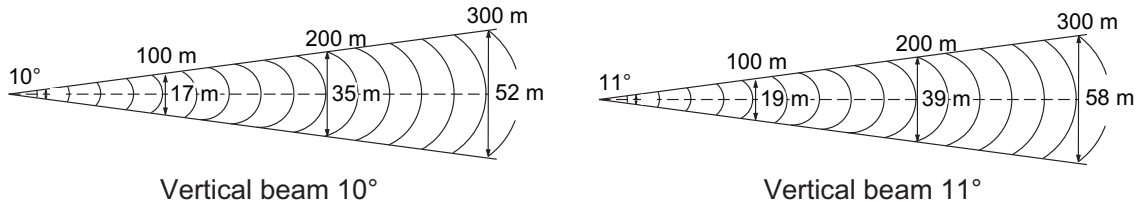

2.5 How to Measure Range and Bearing to a Target

Operate the trackball to place the cursor on the target you want to measure the range and bearing. The range, bearing and depth to the target appear at the upper left corner of the screen.

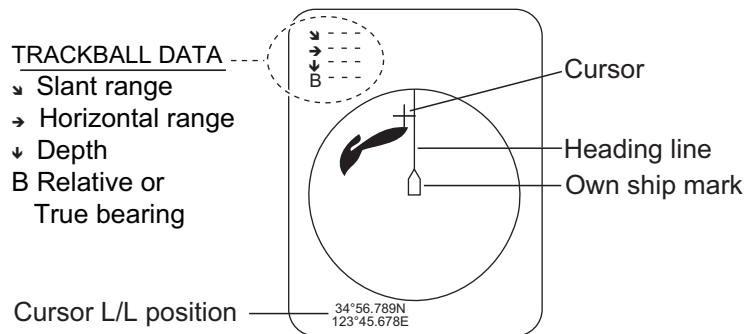

**Note 1:** Trackball position may also be shown in latitude and longitude. For further details, see page 6-12.

**Note 2:** The bearing display is available in four formats. See page 6-12.

## 2.6 How to Eliminate Weak Echoes

Echoes from targets such as bottom and fish return to the transducer in order of distance to them, and when we compare their intensities at the transducer face, those from nearer targets are generally stronger due to little propagation attenuation and little absorption. If these echoes are displayed directly on the screen, the size of the displayed echo from the same school of fish may change with distance, making it difficult to judge the actual size of the school of fish. To overcome this inconvenience use the TVG curve function. This function compensates for propagation loss of sound in water; amplification of echoes on short range is suppressed and gradually increased as range increases so that similar targets are displayed in the similar intensities irrespective of the ranges to them.

### 2.6.1 Change sensitivity of TVG curve

Four TVG curves are available and they vary the gain from large to small.

1. Press the **MENU/ESC** key to open the main menu.
2. Click [Gain Setting].

Gain Setting		Quit
H1 P1	H2 P1	V P1
TVG Curve	:	15Log
Near Gain	:	5.0
Near Gain Distance	:	400m
Far Gain	:	5.0
Far Gain Distance	:	400m
AGC Near	:	4.0
AGC Far	:	4.0
AGC Distance	:	20m
Noise Suppress	:	2.0
Noise Supp. (SHIP)	:	0.0

3. Press the **H/V/S** key to select the [H1] or [H2] tab.
4. Select [TVG Curve].
5. Click ▲ or ▼ to select a suitable Log value.  
The smaller the number, the gentler the gain changes over distance.
6. Click [Quit] on the setting box to close the box.
7. Long-push the **MENU/ESC** key to close all menus.

Quit
Cancel
▲
15Log
▼
(0~40Log)

The TVG is also used to suppress unwanted echoes (sea surface reflections, cruising noise, etc.) on near ranges. If the selected curve does not provide satisfactory results, see section 2.6.2 for how to adjust the near gain and far gain.

## 2.6.2 Change near gain, far gain

This sonar lets you adjust near gain and far gain separately.

1. Press the **MENU/ESC** key to open the main menu.
2. Click [Gain Setting].
3. Press the **H/V/S** key to select the [H1] or [H2] tab.
4. Click [Near Gain Distance] or [Far Gain Distance].
5. Click ▲ or ▼ to select a suitable value.
6. Click [Quit].
7. Click [Near Gain] or [Far Gain].

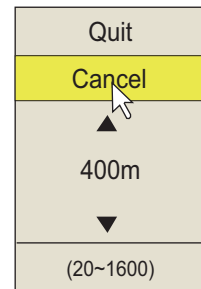

**[Near Gain]:** Adjust sensitivity in area closer than [Near Gain Distance].

**[Far Gain]:** Adjust sensitivity in area further than [Far Gain Distance].

8. Click ▲ or ▼ as appropriate to set.  
The setting range is 0.0 to 10.0. Setting “5” does not correct the gain. Use a setting lower than 4 to lower the gain, or use a setting higher than 5 to raise the gain.
9. Click [Quit] on the setting box.
10. Long-push the **MENU/ESC** key to close all menus.

**Note:** When a school of fish is located on a long-range setting (about 800 meters) and is approaching own ship, do as follows:

- 1) Adjust the tilt to keep the school of fish in the center of the sonar beam, namely, the school of fish is displayed in strongest colors possible.
- 2) Confirm that the fish echo is displayed in the same color as it approaches.
- 3) If the color suddenly changes to weaker colors as the fish enters mid and near distances from your vessel, the near gain is improperly set. Increase the near gain setting to prevent weakening of colors.



## 2.7 How to Adjust Strong, Weak Echoes

### 2.7.1 AGC Near, AGC Far, AGC Distance

The AGC function automatically reduces the receiver gain only against strong echoes such as the bottom or a large school of fish. Since the AGC function does not affect weak echoes, a small school of fish becomes easier to detect. The FSV-25 has three types of AGC settings, [AGC Distance], [AGC Near], and [AGC Far]. Adjust them so that the AGC works only on bottom reflections. Do not set it too high; weak echoes may be missed.

1. Press the **MENU/ESC** key to show the main menu.
2. Click [Gain Setting].
3. Press the **H/V/S** key to select the [H1] or [H2].
4. Click [AGC Distance] to show the setting box.

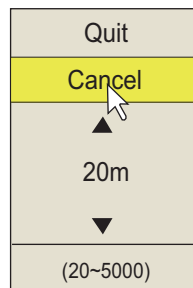

5. Click ▲ or ▼ to change the setting.  
The setting range is 20 - 5000 m, in 20 m increments.
6. Click [Quit] on the setting box to close the box.
7. Click [AGC Near] or [AGC Far] to show the setting box.

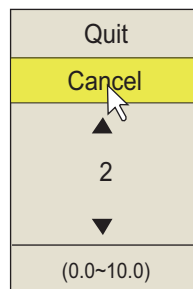

[AGC Near]: Suppress gain in area closer than the [AGC Distance] setting.  
[AGC Far]: Suppress gain in area that is beyond the [AGC Distance] setting.

8. Click ▲ or ▼ to change the setting.  
The setting range is 0.0 - 10.0. The larger the figure the greater the degree of suppression. However, too high a setting may erase weak echoes.
9. Click [Quit] on the setting box to close the box.
10. Long-push the **MENU/ESC** key to close all menus.

### 2.7.2 How to shorten pulse length

The pulse length determines the length of the transmission pulse emitted into the water. While a longer pulse is advantageous for long-range sounding, it has the disadvantage of being poor in discrimination of targets, that is, the ability to separate several closely located targets. When searching bottom fish, therefore, it is useful to shorten the pulse length in order to separate fish echoes from bottom reflections.

**Note:** For search of surface and midwater fish in which bottom reflections are not so strong, use the longest pulse length "9".

1. Press the **MENU/ESC** key to show the main menu.
2. Click [TX/RX Setting].
3. Press the **H/V/S** key to select the [H1] or [H2] tab.
4. Click [TX Pulse Length].
5. Click ▲ or ▼ to change the setting. The setting range is 0 to 9. The higher the setting, the longer the pulse length.

**Note:** The pulse length is automatically set to "9" when the reverberation setting (section 2.9.6) is other than "0".

TX/RX Setting		Quit
H1 P1	H2 P1	V P1
TX Interval	:	9
TX Pulse Length	:	9
TX Power	:	9
Reverberation	:	0
Freq Shift	:	0
Hor. Beam Wid	:	4
Ver. Beam Wid	:	4

6. Click [Quit] on the setting box to close the box.
7. Long-push the **MENU/ESC** key to close all menus.

### 2.7.3 How to suppress unwanted echoes

This sonar's noise suppressor removes weak echoes such as sea surface reflections, plankton, weak echoes from distant bottom echoes, and screw noise from other ships\*. Because the noise suppressor does not work against strong echoes it is useful for detecting schools of fish.

\* Screw noise from other ships may produce strong echoes at distant range, depending on gain setting.

1. Press the **MENU/ESC** key to show the main menu.
2. Click [Gain Setting].
3. Press the **H/V/S** key to select the [H1] or [H2].
4. Click [Noise Suppress] or [Noise Supp. (SHIP)] to show the setting box.
  - [Noise Suppress]: Use this item to suppress sea surface reflections, plankton, and distant bottom echoes.
  - [Noise Supp. (SHIP)]: Use this item to suppress screw noise from other ships.

Quit
Cancel
▲
2
▼
(0.0~10.0)

5. Click ▲ or ▼ to change the setting. The higher the setting, the higher the degree of suppression.
6. Click [Quit] to close the box.
7. Long-push the **MENU/ESC** key to close all menus.

## 2.8 How to Suppress Bottom and Sea Surface Reflections in Shallow Waters

In shallow fishing grounds with hard or rocky bottom, bottom reflections often interfere with wanted fish echoes and they can not be eliminated sufficiently with the aforementioned near gain and AGC functions, especially when the Tilt is set to a larger angle in order to track schools of fish approaching within 400 m. In such cases try to reduce the output power by adjusting the Tx power instead of turning down the gain. The picture becomes clearer when the output power is reduced rather than when the gain is decreased as illustrated below.

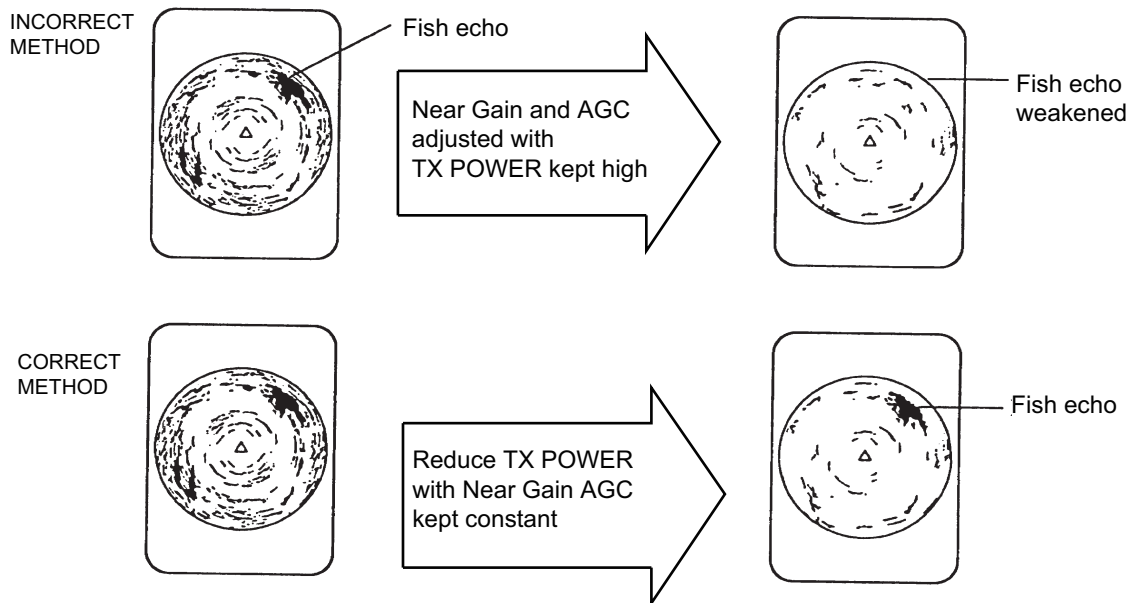

1. Press the **MENU/ESC** key to show the main menu.
2. Click [TX/RX Setting].
3. Press the **H/V/S** key to select the [H1] or [H2] tab.
4. Click [TX Power]
5. Click ▲ or ▼ to change the setting. The setting range is 0 to 9. The higher the setting the greater the TX power.
6. Click [Quit] on the setting box to close the box.
7. Long-push the **MENU/ESC** key to close all menus.

## 2.9 How to Reject Sonar Interference and Noise

While observing the sonar picture, you may encounter occasional or intermittent noise and interference. These are mostly caused by on-board electronic equipment, engine or propeller noise, or electrical noise from other sonars being operated nearby.

### 2.9.1 How to identify the noise source

To eliminate noise effectively, you should first identify the noise source as follows:

1. On the [Test] menu, turn [TX] off to stop transmitting. Turn on the power of all on-board equipment one by one while observing the picture. If noise appears on the sonar display, that equipment is emitting noise. Check the offending equipment's ground and installation.
2. Run the boat at various speeds to check if the noise is speed dependent.

If neither of the above two steps has effect on the picture, adjust one of the following:

### 2.9.2 Change TX interval

When other sonars nearby are operating the same transmission interval as that of own ship's sonar, rings of interference appears on the display.

To remove the rings from the screen, do the following:

1. Press the **MENU/ESC** key to show the main menu.
2. Click [TX/RX Setting].
3. Press the **H/V/S** key to select the [H1] tab.
4. Click [TX Interval].
5. Click ▲ or ▼ to change the setting.
  - 1 to 9: The smaller the number the longer the transmission cycle.
  - [Random1] - [Random4]: Changes the interval with each transmission, to prevent reception of interference in the same timing. The larger the number the greater the average interval.
  - [External Sync]: Synchronizes transmission with the external input signal.
6. Click [Quit] on the setting box to close the box.
7. Long-push the **MENU/ESC** key to close all menus.

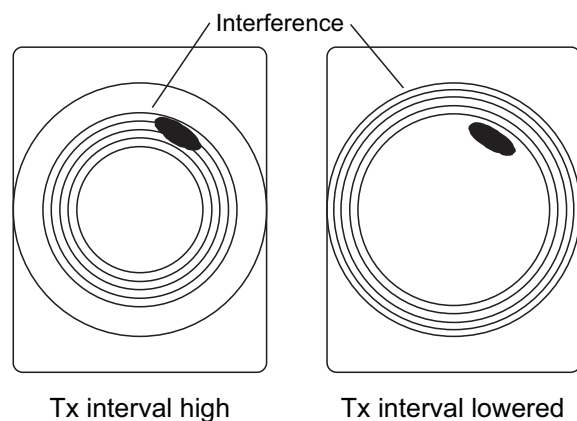

### 2.9.3 Interference rejector

The interference rejector suppresses randomly appearing noise, sea surface reflections, and interference from other acoustic sounding equipment. Set it so that noise is just eliminated. Do not use an unnecessarily high setting since it may also reject small, wanted echoes.

1. Press the **MENU/ESC** key to show the main menu.

2. Click [Picture Setting].

3. Press the **H/V/S** key to select the [H1] or [H2] tab.

4. Click [Int Reject] or [Int Reject (ES)].

- [Int Reject]: Use this item to suppress sea surface reflections, and sea surface reflections.
- [Int Reject (ES)]: Use this item to suppress interference from other acoustic sounding equipment.

5. Click ▲ or ▼ to change the setting.

- [Int Reject]: The setting range is 0 to 3. The degree of rejection in ascending strength is 2, 1, 3. "0" disables the interference rejector.
- [Int Reject (ES)]: Use this item to suppress interference from other acoustic sounding equipment. The degree of rejection in ascending strength is 1, 2, 3. "0" disables the interference rejector.

6. Click [Quit] on the setting box to close the box.

7. Long-push the **MENU/ESC** key to close all menus.

Picture Setting		Quit
H1 P1	H2 P1	V P1
Echo Average	:	3
Int Reject	:	2
Int Reject (ES)	:	2
Smooth Echo RNG	:	2
Smooth Echo CIR	:	0
2nd Echo Rej.	:	0

### 2.9.4 Shift TX frequency

If the interference cannot be suppressed by the interference rejector or change in TX interval, change the TX frequency from the [Freq Shift] menu.

1. Press the **MENU/ESC** key to show the main menu.

2. Click [TX/RX Setting].

3. Press the **H/V/S** key to select the [H1] or [H2] tab.

4. Click [Freq Shift].

5. Click ▲ or ▼ to change the setting. The setting range is -20 to 20.

6. Click [Quit] on the setting box to close the box.

7. Long-push the **MENU/ESC** key to close all menus.

### 2.9.5 Noise limiter

Weak, unwanted reflections, colored light-blue or green, appear when the water is dirty, plankton layers exists, or due to ship's noise. The noise limiter can reduce the effects of these unwanted reflections. Raising the setting causes unwanted reflections to be displayed in colors of blue to background color.

1. Press the **MENU/ESC** key to show the main menu.
2. Click [Display Setting].
3. Press **H/V/S** key to select the [H1] or [H2] tab.

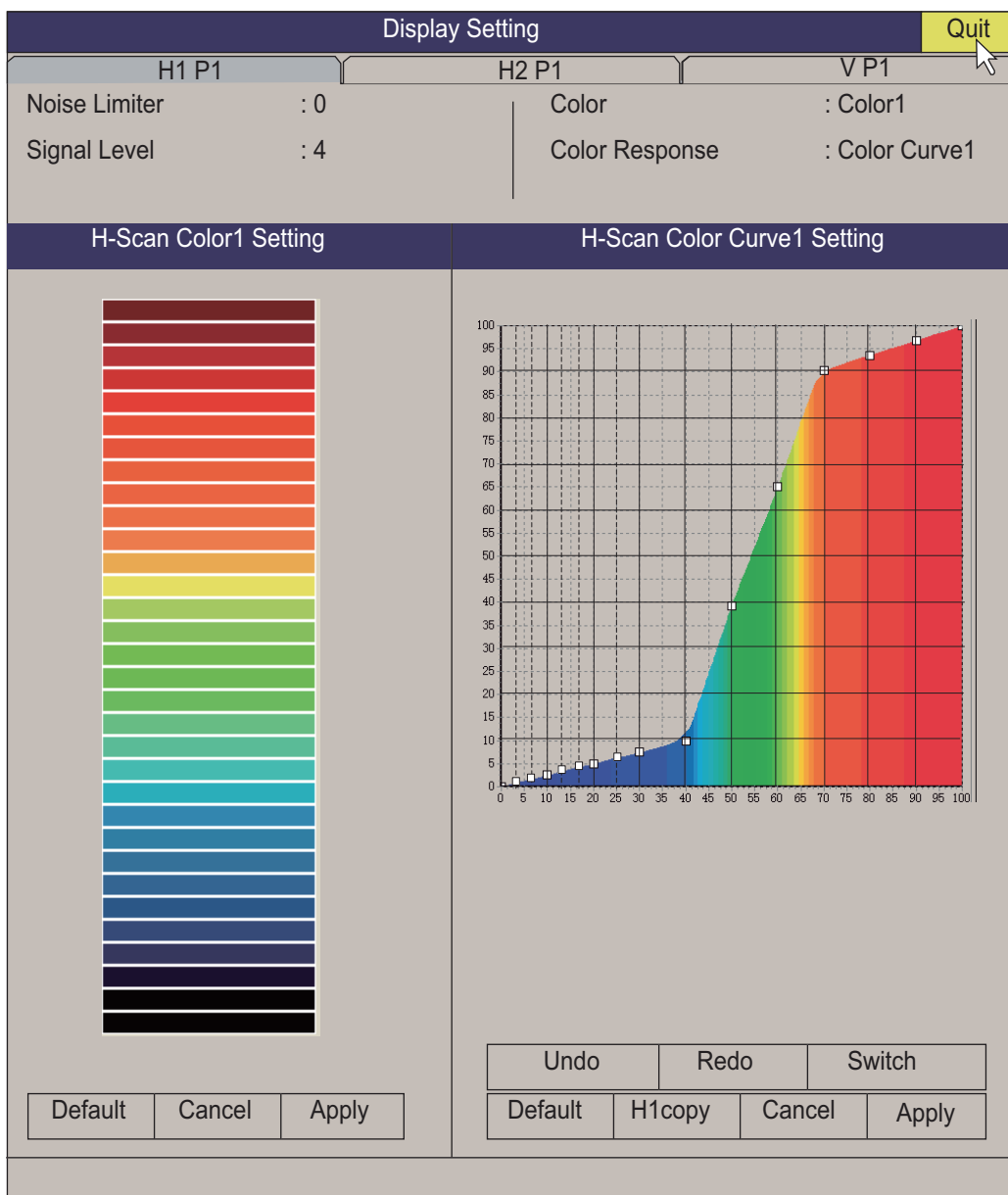

4. Click [Noise Limiter].
5. Click ▲ or ▼ to change setting. The setting range is 0 to 10. The higher the setting, the greater the degree of the suppression.
6. Click [Quit] to close the box.
7. Long-push the **MENU/ESC** key to close all menus.

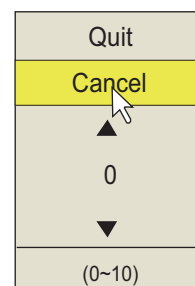

## 2.9.6 Reverberation

You can reduce the strength of reverberation from sea-surface, sea-bottom and plankton layer, with [Reverberation] on the [TX/RX Setting] ([H1] or [H2] tab). The setting range is 0 to 3. The reverberation setting is automatically set to “0” when the range is 100 m or less. The larger the setting, the greater the reduction in reverberation. Select a value that reduces reverberation while showing echo signals clearly.

## 2.9.7 Echo average

[Echo Average] ([H1] or [H2] tab) on the [Picture Setting] menu adjusts echo afterglow - the amount of time an echo signal remains on the screen. This feature can be useful for watching echo movement. The setting range is 0 to 11.

**Setting between 1 and 7:** Echoes are gradually displayed and afterglow remains on the screen longer as the setting is increased.

**Setting between 8 and 11:** Echoes are quickly displayed and afterglow remains on the screen longer as the setting is increased.

## 2.9.8 2nd echo rejection

A target that is farther than the repetition interval of transmission may appear as a virtual image on the screen one time later. This is called secondary echo. Reflections from tracks are so strong that secondary echoes appear easily. To remove secondary echoes, set [2nd Echo Rej.] (located on the [H1] tab of the [Picture Setting] menu) to other than “0” (OFF),

## 2.10 How to Adjust Beamwidth

The width of the horizontal and vertical beam can be adjusted from the [TX/RX Setting] menu.

1. Press the **MENU/ESC** key to show the main menu.
2. Click [TX/RX Setting].

TX/RX Setting		Quit
H1 P1	H2 P1	V P1
TX Interval	:	9
TX Pulse Length	:	9
TX Power	:	9
Reverberation	:	0
Freq Shift	:	0
Hor. Beam Wid	:	4
Ver. Beam Wid	:	4

3. Press the **H/V/S** key to select the [H1] or [H2] tab.
4. Click [Hor. Beam Wid] or [Ver. Beam Wid].
5. Click ▲ (raise setting) or ▼ (lower setting) to adjust the beamwidth. The setting range is 0 to 4. The higher the setting the sharper the beamwidth.
6. Click [Quit] on the setting box to close the box.
7. Long-push the **MENU/ESC** key to close all menus.

## 2.11 How to Track a School of Fish

The target lock function automatically tracks a school of fish so you will not lose sight of it on the display. Two types of target lock are available: position tracking and tracking of school of fish. Select one from the menu as shown in the procedure that follows. The default setting is tracking of school of fish. Speed and bearing data are required. The FSV-25/FSV-25S can not track a school of fish if the level of the echo is too weak.

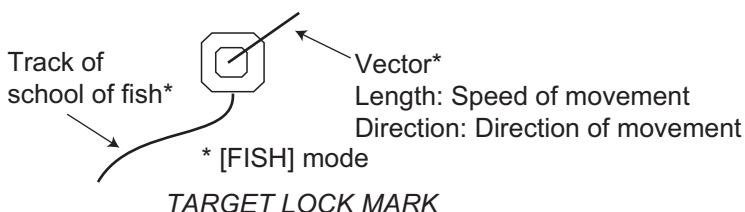

One target lock mark is shown. For the Horizontal 2 display, the mark is shown on the applicable display. The target lock mark does not appear on the displays where it can not be inscribed.

### 2.11.1 How to select the target lock mode

Note that the target lock mode cannot be changed while the target lock mode is displayed.

1. Press the **MENU/ESC** key to show the main menu.
2. Click [Others].
3. Click [Initial Setting].
4. Click [Changeable].
5. Click [Target Lock].

Target Lock		Quit
Tracking Method	: Fish	
Tilt Interlock	: Tilt&Range	
Mark Interlock	: Estimate Mark	
Tracking Data	: H & V	
Threshold	: 16	
Bottom Threshold	: 3	
Target Speed Limit	: 5kn	
Smoothing	: 0.5	
Target SPD Update	: 60Sec	
Target Lock Window	: Small	
Dimension Setup	: 25t/1000m <sup>2</sup>	
Volume Setup	: 25t/1000m <sup>3</sup>	



6. Click [Tracking Method].
7. Click [Fish] or [Target Mark].  
See section 2.11.2 and section 2.11.3.
8. Click [Quit] on the setting box then to close the box.
9. Long-push the **MENU/ESC** key to close all menus.

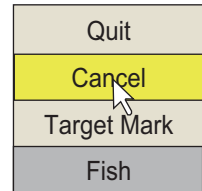

## 2.11.2 Fish mode

The automatic echo target lock function automatically tracks the operator-selected school of fish. When [Tilt Interlock] on the [Target Lock] menu (previous page) is set to [Tilt & Range], and the tracked school of fish goes out of the zone in the range direction, the range and tilt are automatically controlled according to the position of the school of fish.

1. Select [Fish] in the procedure in section 2.11.1.
2. On the horizontal display, use the trackball to select the school of fish to track.
3. Press the **TARGET LOCK** key.

The target lock mark with vector is put on the school of fish. The color of the mark is initially red, and turns white when the echo is recognized as a school of fish. The vector shows the speed and direction of movement of the school of fish. The tip of the vector is the estimated position of the school of fish when the vector time elapses. The target lock mark appears on the vertical display, however the vector is not shown.

If the target is lost, the target lock mark changes to red color and the tracking mode changes to position mode (see the next section) at that position. When the sonar detects and tracks the target again, the FISH mode is restored.

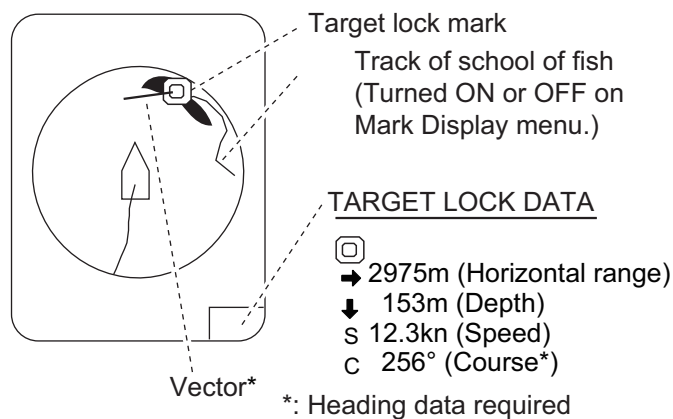

4. To disable the target lock, press the **TARGET LOCK** key.

### 2.11.3 Target mark mode

This mode tracks a stationary position (such as a reef) using position data fed from a navigator.

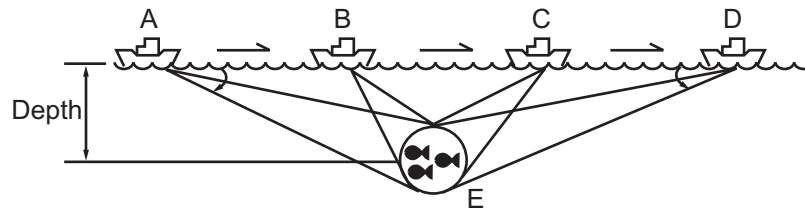

1. Select [Target Mark] in the procedure in section 2.11.1.
2. On the horizontal display, use the trackball to select the location to track.
3. Press the **TARGET LOCK** key.  
Tilt, range and vertical bearing are automatically adjusted to track the location. Using the figure above as an example, the target lock mark is placed on location E. Then, the equipment remembers the location of E and automatically changes the tilt angle as the ship moves from position A through D. As long as the school of fish E is stationary its echo is kept displayed on the screen.
4. To disable the target lock, press the **TARGET LOCK** key.

### 2.11.4 Target lock menu description

Target lock functions not previously mentioned are described below.

**[Tilt Interlock]:** Provides automatic change of tilt angle and range or tilt angle in target lock. (Setting options: [OFF], [Tilt], [Tilt & Range])

**[Mark Interlock]:** Turns numeric/graphic data displays ON/OFF in target lock. (See section 4.1.) [Off] disables the histogram display and fish information for estimate mark 1. [Estimate Mark] displays the histogram display for estimate mark 1. [Est & Fish Info] displays the histogram display and fish information for estimate mark 1.

**[Tracking Data]:** Selects which target lock tracking data to use, horizontal or both horizontal and vertical.

**[Threshold]:** Selects the minimum signal level to use in target lock tracking. The setting range is 1 to 30. Target lock tracks a target whose signal level is greater than set here.

**[Bottom Threshold]:** When a target is judged as a bottom echo, raise this setting to differentiate bottom from target. The setting range is 0 to 5.

**[Target Speed Limit]:** Sets maximum fish speed to track. The setting range is 1 kn to 15 kn.

**[Smoothing]:** Sets smoothing rate for fish speed data. The higher the setting, the smoother the position of the target lock target. Avoid oversmoothing, to prevent delay in tracking when own ship or target moves suddenly. The setting range is 0.0 to 1.0.

**[Target SPD Update]:** Sets the interval at which fish speed data is updated. The intervals are 15, 30, 45 and 60 seconds.

**[Target Lock Window]:** Selects the size of target lock detection area; [Small], [Large], [Largest]. (The area is not indicated on the screen.)

**[Dimension Setup]:** Sets dimension constant for calculation of weight (ton) of school of fish from the dimension of the school of fish. The setting range is 0 to 100 t/1000 m<sup>2</sup>.

**[Volume Setup]:** Sets volume constant for calculation of weight (ton) of school of fish volume. The setting range is 0 to 100 t/1000 m<sup>3</sup>.

## 2.12 Presentation Mode

### 2.12.1 Presentation mode description

This sonar has four presentation modes, head-up, north-up, course-up and true motion. Select one with [Presentation Mode] in the [Others] - [Display Setting] menu.

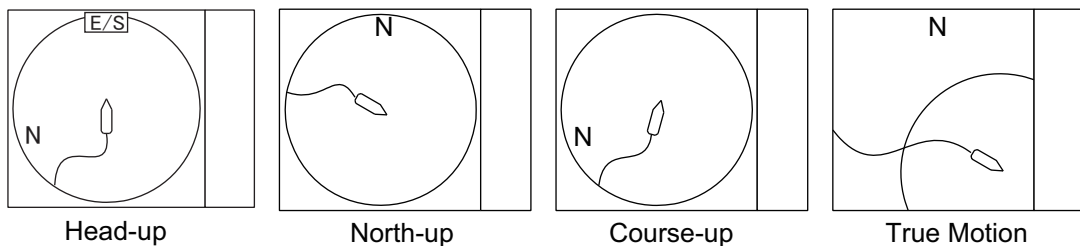

**Head-up:** The display is oriented toward ship's heading. The heading direction appears at the top of the display. Own ship position is fixed at the screen center. Echoes from fish and the bottom move on the screen relative to own ship's movement. This mode is useful for general use.

**North-up:** The display is oriented so North is at the top of the screen. Own ship position is fixed at the screen center and own ship mark pivots with ship's movement. Echoes from fish and the bottom move on the screen relative to own ship's movement.

**Course-up:** The display is oriented according to course. Own ship position is fixed at the screen center. Echoes from fish and the bottom move on the screen relative to own ship's movement. Targets are displayed at ship's bow.

**True Motion:** Stationary objects are fixed and own ship and fish echoes move on the display in accordance with their true courses and speeds. Thus you can observe own ship and fish echo movement with respect to the bottom. This mode requires speed and heading data. When own ship mark reaches an edge of the off-center effective area it is automatically returned to the screen center as below.

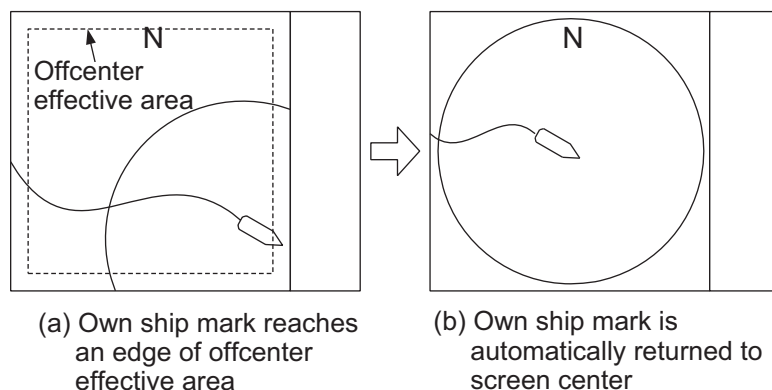

*Automatic return of own ship mark in true motion*

### 2.12.2 How to select a presentation mode

1. Press the **MENU/ESC** key to show the main menu.
2. Click [Others].
3. Click [Display Setting].
4. Click [Presentation Mode].
5. Click desired mode.
6. Click [Quit] on the setting box to close the box.
7. Long-push the **MENU/ESC** key to close all menus.

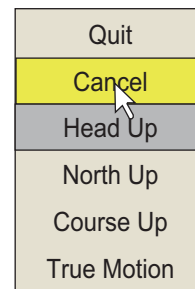

**Note:** The true motion display range may be set to 1.3 to 1.6 times the range with [TM Disp Range] on the [Display Setting] menu.

## 2.13 How to Detect Schools of Fish Aurally

Sometimes you may be preoccupied with other tasks and unable to concentrate on watching the sonar picture. In such cases it would be a good choice to use the audio function. This function enables you to monitor echoes from schools of fish and bottom through the external speaker.

### 2.13.1 How to set the bearing

In the default setting, the audio function is on and the audio sector is 30°.

1. Operate the trackball to place the cursor on the direction you want to monitor through the speaker.
2. Press the **R/B AUDIO** key.

The monitoring section is set on the bearing selected, in a 30°, 60°, 90°, 180° or 330° sector centering the audio bearing mark. Echoes are monitored through the speaker.

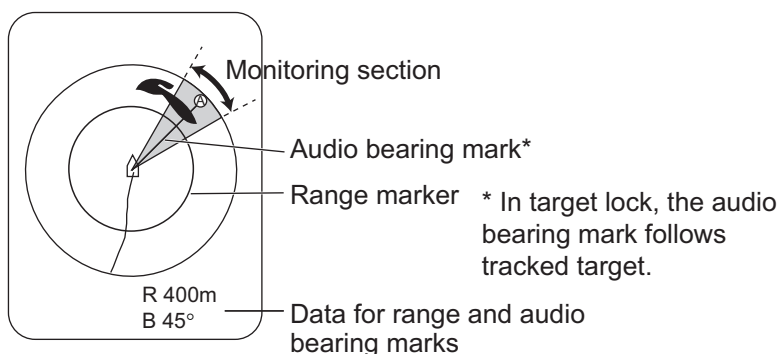

**Note:** To erase the range mark and its data (at the bottom of the screen), put the cursor near own ship mark (transducer position) and press the **R/B AUDIO** key. Note that the audio bearing is erased when [Audio] on the [Alarm & Audio] menu is turned off.

### 2.13.2 How to select the audio sector

Select the audio sector as follows. Note that you cannot see this sector on the display.

1. Press the **MENU/ESC** key to show the main menu.
2. Click [Others].
3. Click [Alarm & Audio].

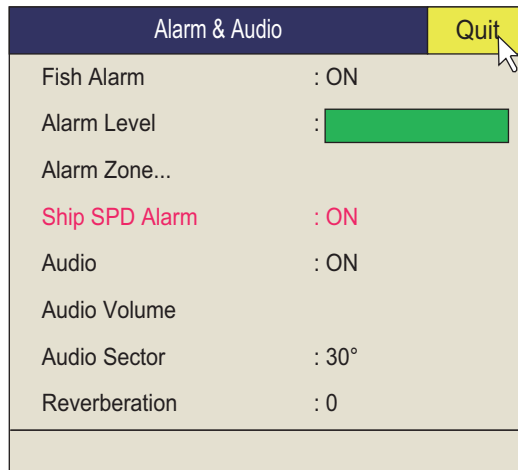

4. Click [Audio Sector].

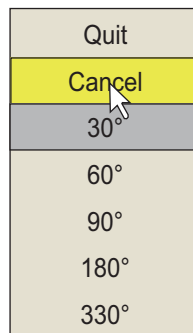

5. Click desired sector.
6. Click [Quit] on the setting box to close the box.
7. Long-push the **MENU/ESC** key to close all menus.

### 2.13.3 Automatic training

You may automatically scan the audio sector and audio bearing mark in the sector of  $\pm 12^\circ$ ,  $\pm 24^\circ$  or  $\pm 36^\circ$  as shown below.

1. First activate the range and audio bearing marks with the **R/B AUDIO** key.
2. While pressing and holding down the **AUTO TRAIN** key, press the **R/B AUDIO** key to select desired auto train sector among  $\pm 12^\circ$ ,  $\pm 24^\circ$  or  $\pm 36^\circ$ , or OFF to disable automatic training.

Watch the auto train mark to know the currently selected sector. The chosen sector appears in large characters for five seconds at the top of the screen.

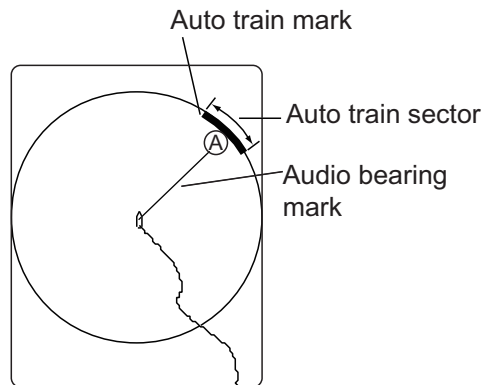

**Note 1:** The automatic training is inoperative when the target lock function is active. Turn off the target lock function to use automatic training.

**Note 2:** Select [Off] at step 2 to stop the training.

### 2.13.4 Reverberation for audio signal

You may select the length of reverberation of the audio signal, with [Reverberation] on the [Alarm & Audio] menu. The larger the value the longer the reverberation, which makes it easier to hear the audio signal. The setting range is 0 to 9 and the default setting is 0.

## 2.14 Fish Alarm

The fish alarm sounds the aural alarm when a fish echo above a preset strength enters the operator-set alarm zone.

### 2.14.1 How to set the fish alarm

1. Press the **MENU/ESC** key to show the main menu.
2. Click [Others].
3. Click [Alarm & Audio].
4. Click [Fish Alarm].
5. Click [ON] to turn on the alarm, or [OFF] to turn off the alarm.
6. Click [Quit] from the setting box then left-click to close the box.
7. Click [Alarm Zone].
8. Operate the trackball to place the cursor on the starting point of the alarm zone then push the left button.

9. Rotate the trackball clockwise to select the ending point then push the left button. The display paints a fan-shaped alarm zone. The alarm range appears on the display as shown below.

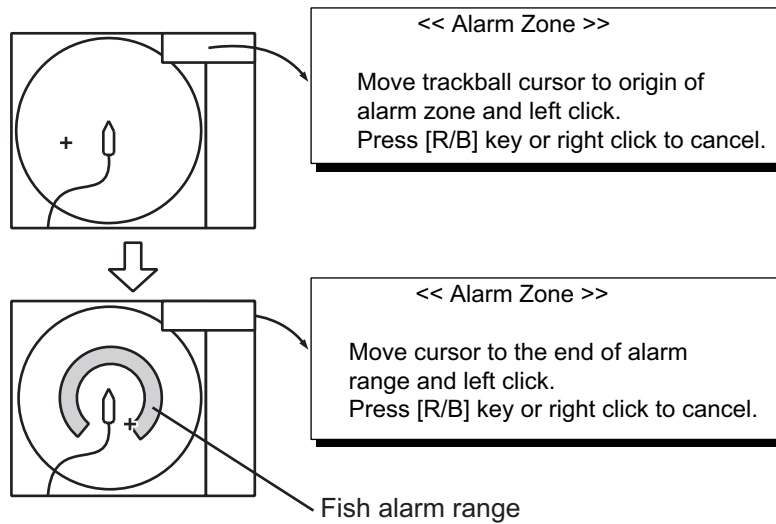

10. Long-push the **MENU/ESC** key to close all menus. When a fish echo enters the alarm area the buzzer sounds.

**Note 1:** There must be at least  $3^\circ$  difference between the starting and ending points to get a fan-shaped alarm zone as shown in (a) and (b) below. Otherwise, the unit paints a  $360^\circ$  alarm zone as in (c) where there is less than  $3^\circ$  between the starting and ending points.

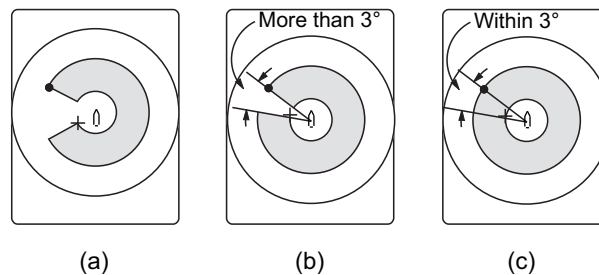

### 2.14.2 How to set the fish alarm level

You can set the echoes colors that trigger the fish alarm.

1. Press the **MENU/ESC** key to show the main menu.
2. Click [Others].
3. Click [Alarm & Audio].
4. Click [Fish Alarm Level].



5. Click the weakest color that is to trigger the fish alarm. Echoes equal to or stronger than the color selected will trigger the fish alarm.
6. Click [Quit] on the setting box to close the box.
7. Long-push the **MENU/ESC** key to close all menus.



## 2.15 How to Relocate a School of Fish

The offcenter feature relocates a school of fish.

1. Operate the trackball to place the cursor on the position where you want to relocate the own ship mark.
2. Press the **OFF CENTER** key.
3. To move the own ship mark back to the screen center, press the **OFF CENTER** key again.

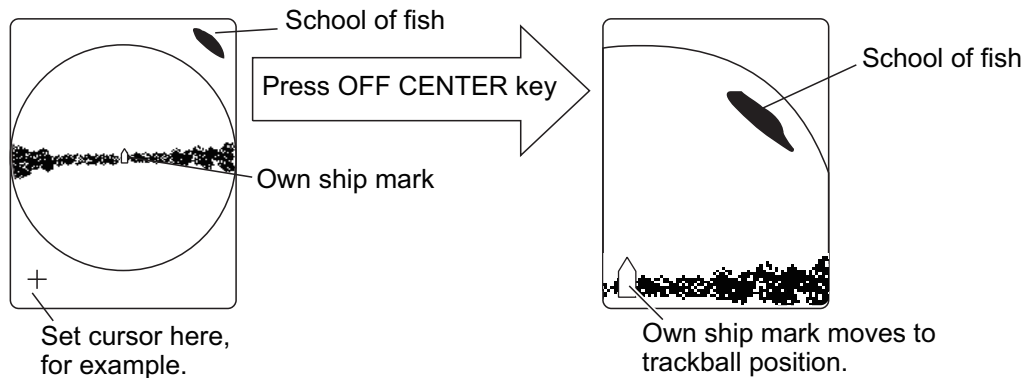

**Note 1:** The offcenter feature cannot be canceled in the true motion mode. Switch the mode to cancel the offcenter. When the **OFF CENTER** key is pressed, the own ship mark moves to the cursor position.

**Note 2:** You can also activate the offcenter feature by long-pushing the left button with the cursor in the echo display area. To restore the normal display, long-push the right button.

## 2.16 How to Compare Concentration of School of Fish

### 2.16.1 How to compare with the fish estimate mark

You can get an estimate of the volume of two schools of fish by using the two **ESTIMATE** keys as follows:

1. Operate the trackball to place the cursor on a school of fish, and then press the **ESTIMATE 1** key.  
The estimate mark 1 appears on the school of fish. Relative volume is shown by a figure between 0 and 100, below the estimate mark. When the area inside the mark is filled in reddish brown, volume figure is said to be 100. When the estimate mark is entered, a graph is shown at the histogram on the numeric/graphic data display.
2. Operate the trackball to place the cursor on another school of fish, and then press the **ESTIMATE 2** key.  
Compare estimate figures for each school of fish by observing estimate mark data and the fish histogram.
3. To turn off the estimate marks press their respective keys.

## 2. HORIZONTAL MODE

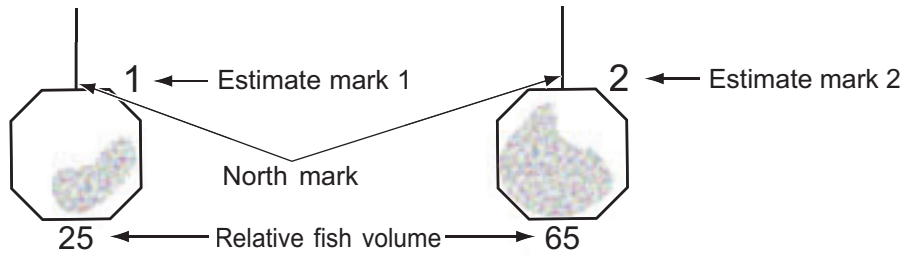

**Note:** The fish school mark and event mark 1 can be entered with the fish estimate mark. For details, contact your dealer.

### **Fish histogram**

The fish histogram shows, in graph form, signal strength distribution for the school(s) of fish marked with an estimate mark on the horizontal displays. The histogram display for each of those displays will be different since the calculation method is different. This data appears only when an estimate mark is active. When two estimate marks are active, histograms are displayed one on top of the other as below.

The horizontal axis shows signal strength in 16 colors, and the vertical axis shows the concentration of a school of fish inside the fish estimate mark. For the fish estimate mark inscribed on the horizontal display the graph shows the average movement in five scans, to increase accuracy.

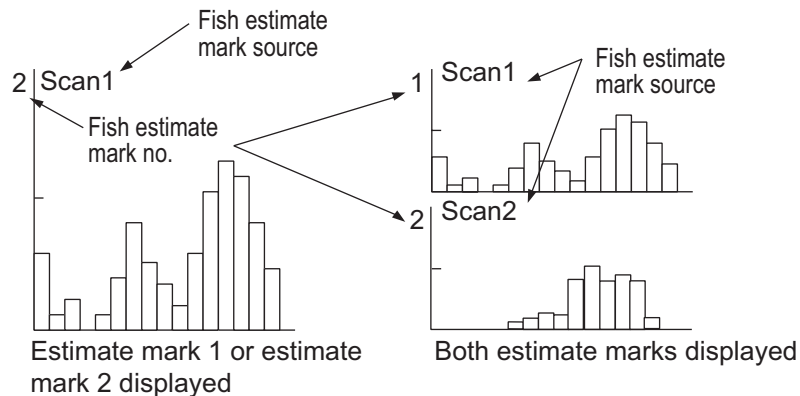

**Note:** The histogram display is redrawn five transmissions after a fish estimate mark is erased and another mark of the same number is entered soon after.

### 2.16.2 How to compare with the circle cursor

You can get an estimate of the volume of two schools of fish with the circle cursor as follows:

1. Push the scrollwheel to show the circle cursor.  
The cross cursor changes to the circle cursor (dotted line).

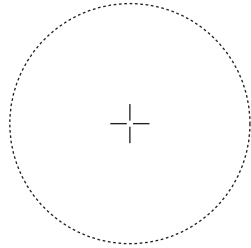

83 m ← Diameter of the circle cursor

2. Place the circle cursor on a school of fish.
3. Rotate the scrollwheel to adjust the size of the circle cursor.  
Set the school of fish in the circle cursor to estimate correctly. The diameter of the circle cursor is displayed below the circle cursor.  
**Note:** The last digit is rounded off when the diameter is greater than 100 m.
4. Place the circle cursor on another school of fish to estimate the volume.  
You can compare the volume of two schools of fish with the diameter of the school of fish.
5. Right click to quit the measurement.  
The circle cursor is changed to the normal cursor.

**Note:** Set the diameter of the circle cursor at [Circle Cursor Diameter] in the [Display Setting] menu (default: 200 m). See section 6.3.

## 2.17 How to Measure the Speed of a School of Fish

To ensure a good haul, it is important to estimate the direction and speed of the school of fish before shooting the net. You can do this with the **FISH** key. With tidal current data and fish speed data, you can determine the timing of the net shooting more efficiently. This function requires speed and heading data.

### 2.17.1 How to measure the speed of a school of fish

1. Place the cursor on the center of a school of fish then press the **FISH** key or push the left button. The latest fish mark (◇) appears on the school of fish.
2. Wait until the target fish moves a reasonable distance from the latest fish mark.
3. Place the cursor on the same school of fish selected in step 1 then press the **FISH** key.

The latest fish mark appears on the target, the 2nd latest fish mark (◇) appears on the location selected at step 1 and any earlier fish marks are shown with an X. The distance between the two fish marks and speed, course, and bearing of the school of fish appear at the bottom right-hand corner of the horizontal display area.

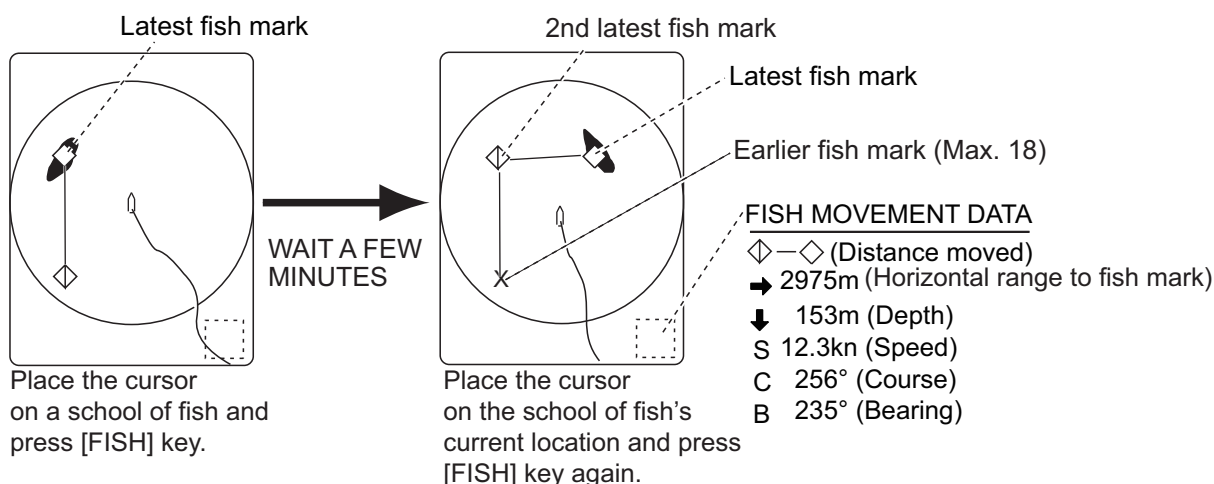

**Note 1:** The time and distance between each press of the **FISH** key should be as long as possible to increase accuracy of measurement. For best results, repeat the procedure two or three times.

**Note 2:** In the default arrangement, a mark can be entered by left clicking in the display area.

**Note 3:** Each time the **FISH** key is pressed the latest fish mark and ship's speed mark change in the sequence shown below. A maximum of 20 fish marks can be entered. When you enter more than 20, the earliest fish mark is erased.

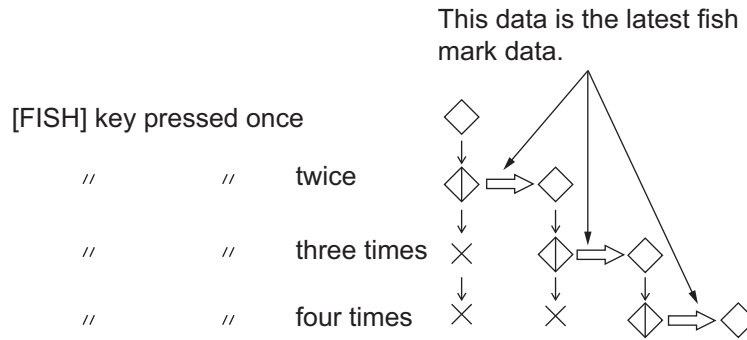

## 2.17.2 How to delete fish marks

Fish marks can be deleted individually with the **DELETE MARK** key or by earliest entry from the menu.

### How to delete fish marks with the DELETE MARK key

Use the trackball to place the cursor on the fish mark you want to erase. The color of the fish mark changes from white to red when the fish mark is correctly selected. Press the **DELETE MARK** key to delete the fish mark.

### How to delete fish marks from the menu

1. Push the right button on the numeric/graphic data display to show the pop-up menu.
2. Click [Erase Marks].

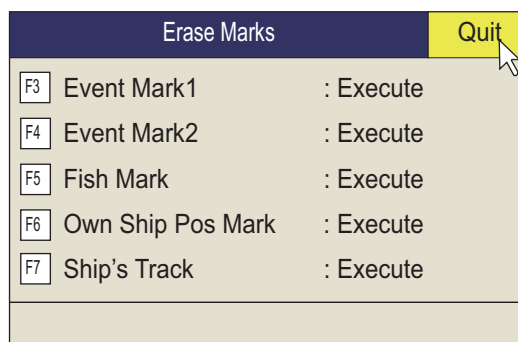

3. Click [Fish Mark]. Each click deletes the earliest fish mark.
4. Long-push the **MENU/ESC** key to close all menus.

**Note:** The default function of the **F5** key deletes the earliest fish mark.

## 2.18 Event Mark, Own Ship Position Mark

The event mark is useful for finding the horizontal range, depth and bearing to a location some distance from current position. 20 such marks may be inscribed on the horizontal display. This function requires speed and heading data.

There are two types of event marks, latest event mark 1 ( $\oplus$ ) and event mark 2 ( $\otimes$ ). Each time an event mark is entered the latest event mark appears at the cursor position and all other event marks are shown by marks  $+$ ,  $\wedge$  and numbered in sequential order. When the memory capacity for event marks is reached the earliest event mark is automatically erased to make room for the latest.

### 2.18.1 How to enter an event mark

1. Set the cursor where you want to enter an event mark.
2. Press an **EVENT** key. The horizontal range, depth and bearing to the event mark appear at the bottom left corner of the horizontal display area. The event mark 1 can also be entered by pushing the right button.

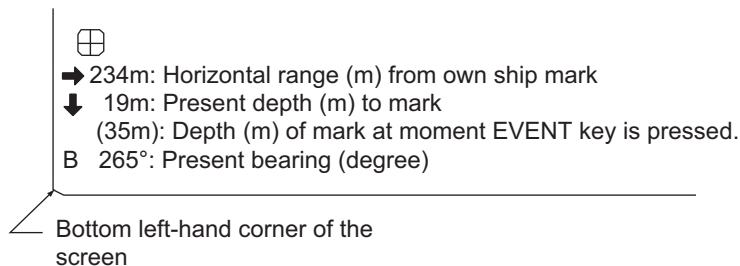

Ex. Indications when the **EVENT**  $\oplus$  key is pressed

With speed and heading data the mark follows own ship's movements. In the True Motion mode, the event mark is stationary. When the tilt angle is changed, the present depth to event mark changes. Note however that the mark's position does not change when automatic tilt is active; the tilt center angle is used to position the mark.

Plotting an event mark on the display is equivalent to dropping a buoy with an anchoring chain that extends from surface to bottom. The buoy is fixed at its geographical location, but the marker on the display moves to a point where the present beam plane intersects the anchor chain of the buoy as the ship moves or the tilt angle is changed. This can be said about marks as well such as fish mark and cursor.

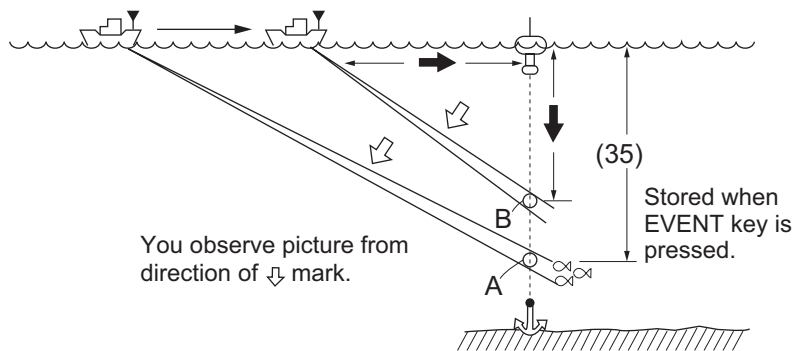

### 2.18.2 How to enter an own ship position mark

Place the cursor close to the center of the own ship mark (transducer position) and press the **EVENT** key. Ten own ship position marks may be inscribed. When the capacity for own ship position marks is reached the earliest own ship position mark is automatically erased.

**Note:** The **SHOOT** key can enter the own ship position mark. Set [Event Key] to [Shoot] on the [Mark Display] menu.

### 2.18.3 How to erase an event mark, own ship position mark

Event marks and own ship position marks can be deleted individually with the **DELETE MARK** key or by earliest entry from the menu.

#### Delete an event mark, own ship position mark with MARK DELETE key

Use the trackball to place the cursor on the event mark or own ship position mark you want to erase. The color of the mark changes from white to red when the mark is correctly selected. Press the **DELETE MARK** key to delete the mark.

#### Delete an event mark, own ship position mark from the menu

1. Push the right button on the numeric/graphic data display to show the pop-up menu.
2. Click [Erase Marks].
3. Click [Event Mark1], [Event Mark2] or [Own Ship Pos Mark]. Each click deletes the oldest event mark or own ship mark.
4. Long-push the **MENU/ESC** key to close all menus.

**Note:** The default function of the **F3** (for event mark 1), **F4** (for event mark 2) and **F6** (own ship position) keys delete the oldest event mark or own ship mark.

## 2.19 Select Mark Window

From the [Select Mark] window, you can enter event mark 1, event mark 2, fish mark, target lock mark, fish abundance mark 1, and fish abundance mark 2. Additionally, you can switch between the cross cursor and the circle cursor.

To open the [Select Mark] window, long-push the scrollwheel. To enter a mark, left or right click a mark on the window, then left click where you want to enter a mark. For the circle cursor, left or right click the circle cursor on the window, and the cross cursor changes to the circle cursor (dashed line).

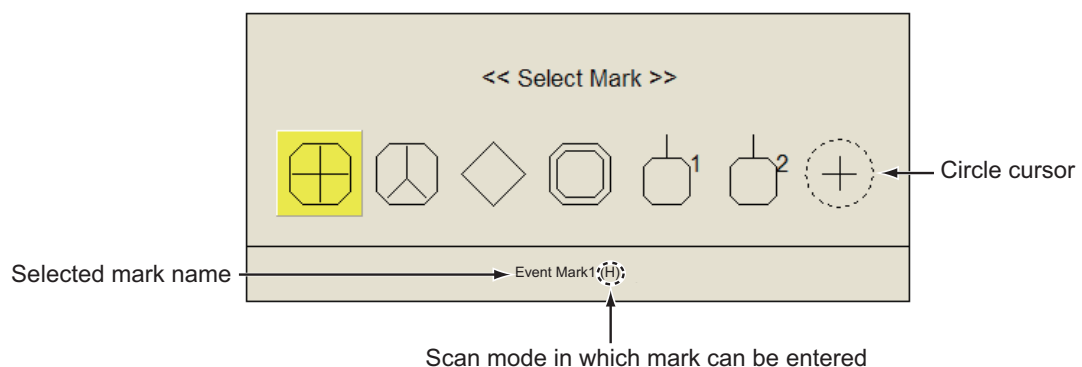

## 2.20 Net Course Mark

Before shooting the net, decide the shoot timing considering tide direction, distance to the school of fish and moving direction of the school of fish. Use the net course mark as a guide to decide the timing. This function requires speed and heading data.

### How to enter the net course mark

1. Press the **MENU/ESC** key to show the main menu.
2. Click [Others].
3. Click the [Display Setting].
4. Click the [Net Course Mark].

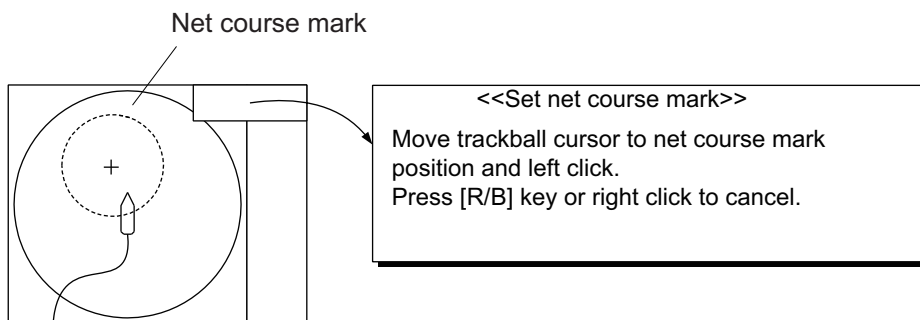

5. Use the trackball to position the net course mark, which is shown by a dashed circle.
6. Push the left button to set, and the dashed circle changes to a solid one.
7. Long-push the **MENU/ESC** key to close all menus.

**Note 1:** To delete the net course mark select [Delete] at step 4.

**Note 2:** The default function of the **F9** key deletes the oldest net course mark.



## 2.21 Net Behavior

With connection of a net sonde, you can observe net behavior after the throwing of the net. Accurate depiction of net sonde position depends on proper setting of the distances between net sonde transmitters. You can set those distances on the main menu-[Others]-[Initial Setting]- (Change confirmation window) - [Net Sonde Setting] menu. This function requires speed and heading data.

**Note:** To enable this feature, set [Event Key] to [Event] in the [Mark Display] menu, then do the following:

1. Press the **SHOOT** key just upon throwing the net into the water. The following actions occur:
  - Net shoot mark (◻) appears at own ship position.
  - Net shoot data appears at top of the display.
  - Net sonde mark (◻<sup>1</sup>, ◻<sup>2</sup>) is inscribed.
  - Net depth data is displayed.
2. To erase the net sonde mark and associated data, press the **SHOOT** key again.

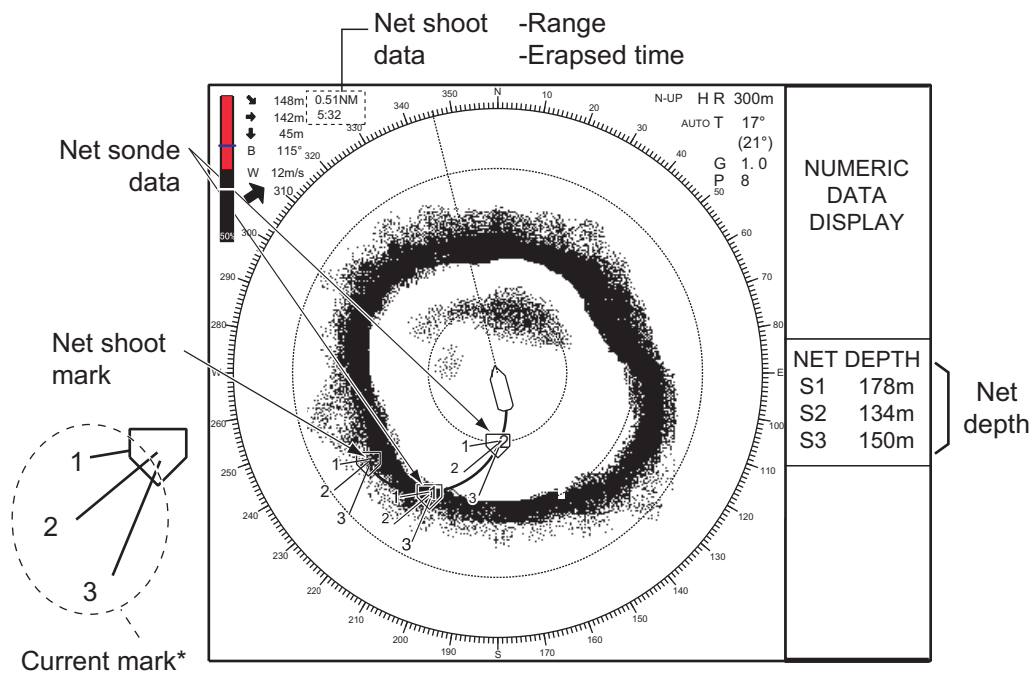

**Note:** To turn the current mark on/off, see page 6-13.

## 2.22 Other Menu Items

This section presents an overview of the horizontal display related menus not previously described.

### 2.22.1 Display Setting menu

#### How to change a color

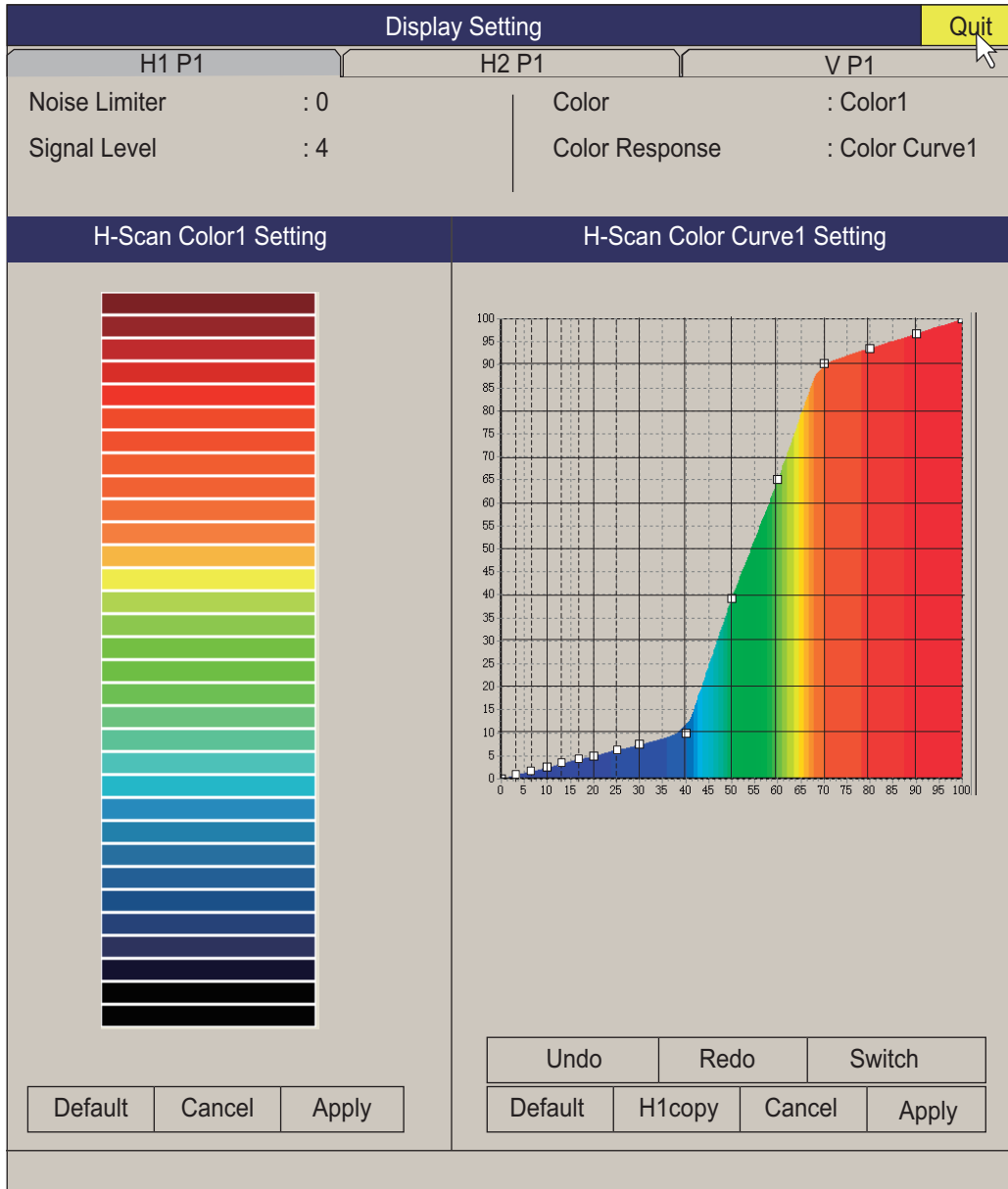

**[Signal Level]:** Contaminated water or reflections from plankton may be painted on the screen in green or light-blue. These echoes may be erased in order of strength. The setting range is 0 to 31; 0 corresponds to the weakest color.

**[Color]:** Selects color arrangement to use. The default setting is Color 1 to 4.

**[Color Response]:** Defines reflected echo strength versus color level conversion. You can select one of four color response tables.

**[H-Scan Color1 (or 2 to 4) Setting]:** Customizes colors. See the procedure on the next page.

1. Operate the trackball to select color then push the left button to show the color bar.

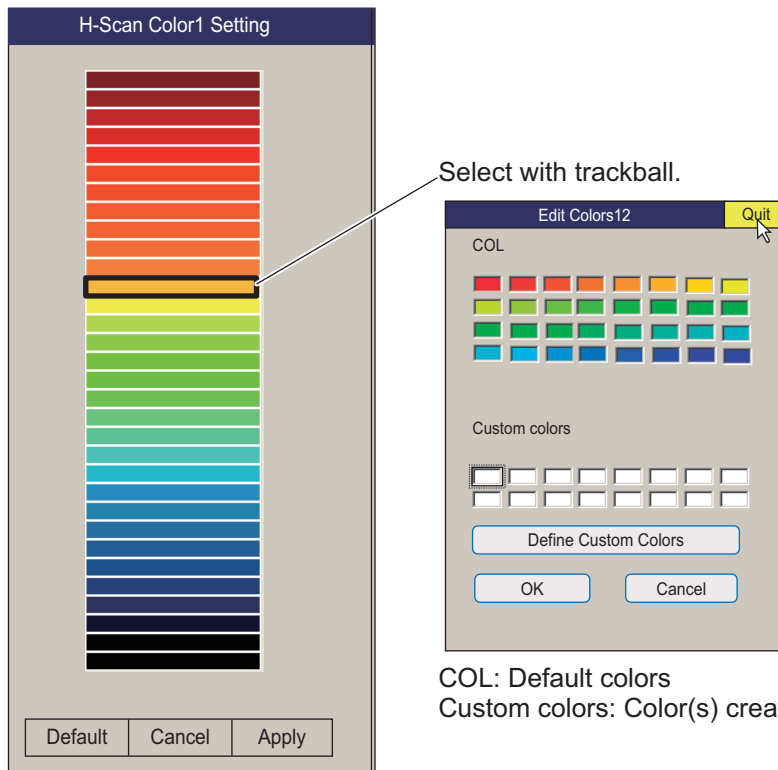

COL: Default colors  
 Custom colors: Color(s) created with Add Color.

2. Select color from [COL] or [Custom colors].
3. Click [Quit].
4. Repeat steps 1 through 3 to set other colors.
5. Click the [Apply] button.

**Note:** To restore default color setting, select [Default] on the window then push the left button.

## 2. HORIZONTAL MODE

### How to add a new color

You can add a new color to the horizontal scan displays (1-4).

1) On the color setting window, click [Define Custom Colors].

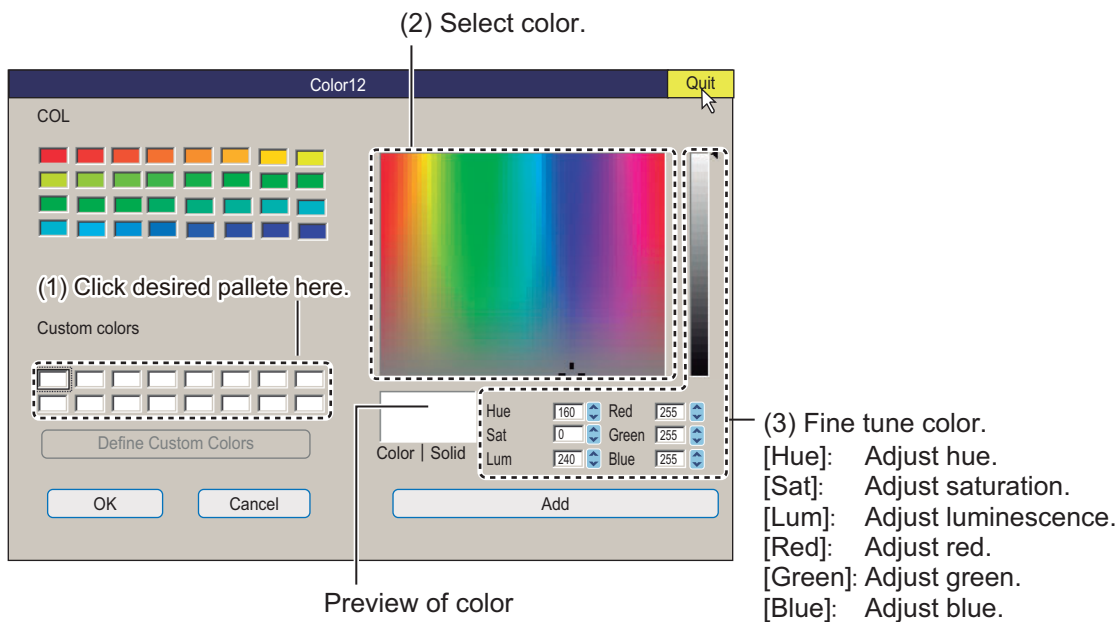

2) Click a color in the color window at the left. The color selected appears in the preview window. Fine tune the color with the color adjustment colors to the right of the preview window.

3) Click the Add button. The color appears in a box in the [Custom colors] window.

**[H-Scan Color Curve Setting]:** Adjusts reflected echo strength versus echo color level for currently selected color response number. There are two methods by which to adjust the curve. Click the [Switch] button to select the method.

**Setting method 1:** Place the trackball at the point desired then push the left button. On the horizontal axis, input level relative value is shown in the range from 0 to 100%. The setting range for input level is 0-100% in increments of 10% and output level is 0-100% in any value. The input (horizontal axis) has 16 settable points and the output (vertical axis) can be set anywhere.

**Setting method 2:** Place the cursor on the color desired then roll the scrollwheel. You can also drag and drop.

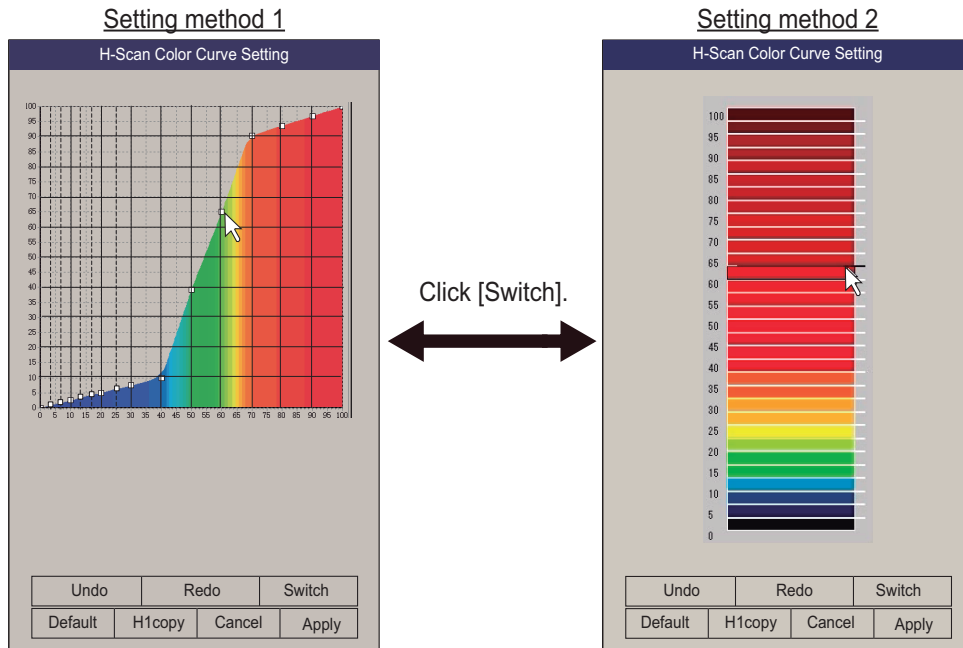

Button	Function
Undo	Undo last action. The sonar stores the last 10 operations.
Redo	Redo last action.
Switch	Switch color setting method.
Default	Restore default settings.
H1copy	Copy the color (1 - 4) and color curve (1 - 4) set at tab [H1] to the corresponding items on the [H2] and [V] tabs. In order to copy color data from the [H1] tab, the color and color curve settings between the [H1] and [H2] (or [V]) tabs must be identical. For example, if the [H2] tab's color setting is 2 and its color curve is 2, the same settings must be set on the [H1] tab.
Cancel	Cancel setting.
Apply	Apply setting.

**Picture Setting menu**

**[Smooth Echo RNG]:** Selects echo smoothing level in the range direction. The setting range is 0 to 5. The higher the setting, the greater the smoothing.

**[Smooth Echo CIR]:** Selects echo smoothing level in the circular direction. The setting range is 0 to 4. The higher the setting, the greater the smoothing.

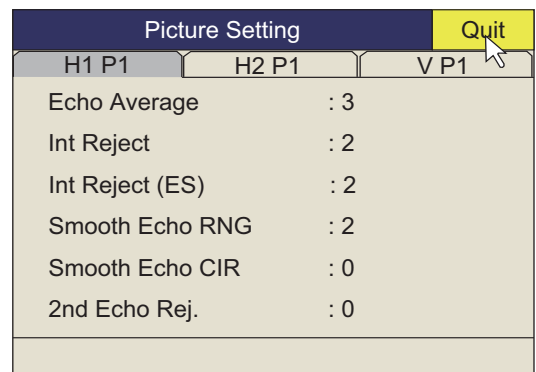

## 2.23 How to Interpret the Horizontal Display

### 2.23.1 Bottom and school of fish echoes

#### Bottom echoes

When the tilt angle is changed, the bottom echo illustrated below will appear on the display. When the tilt is decreased (toward 0°), the bottom trace becomes wider and weaker. By observing the bottom condition on the display, the skipper can prevent net damage.

(A) Flat bottom

Tilt angle: 10° to 15°

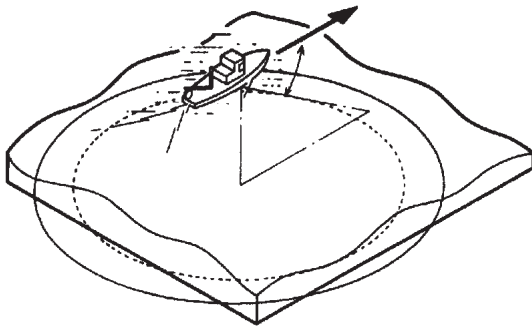

Bottom echo

The bottom echo is captured by the entire beam. The bottom echo in the foreground is strong; weak on the periphery.

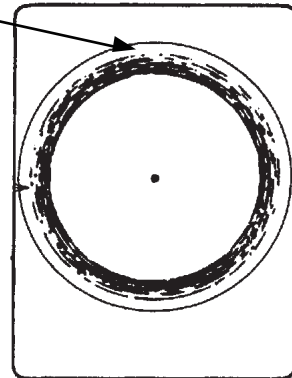

(B) Flat bottom

Tilt angle: 20° or more

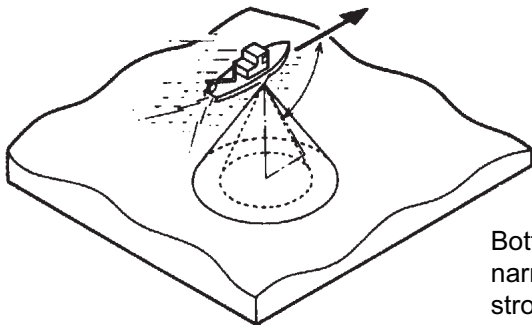

Bottom is displayed narrower and in stronger colors when compared to (A).

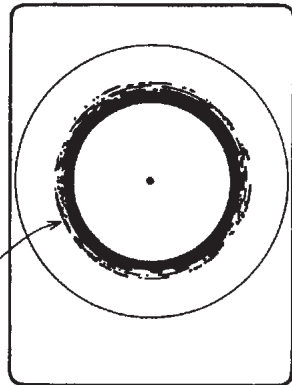

(C) Sloping bottom

Tilt angle: 20° or more

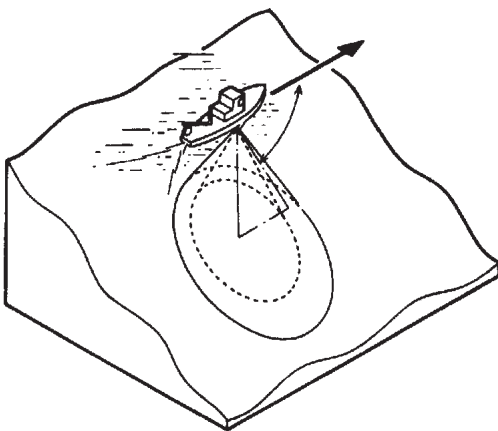

Shallow bottom is displayed in a strong color and with a short tail

Bottom

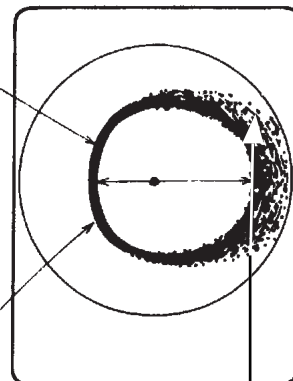

The deeper, sloping bottom echo is displayed in a weak color and with a long tail.

**School of fish**

A school of fish appear as a mass of echoes on the screen. By this display pattern, the density of the school on the sonar beam can be found. To find distribution and center point of a school of fish, try several different tilt angles.

(A) Sea surface fish  
Tilt angle: 0° to 10°

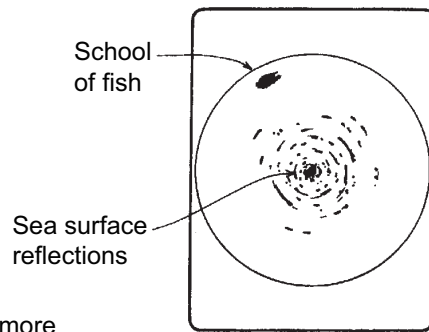
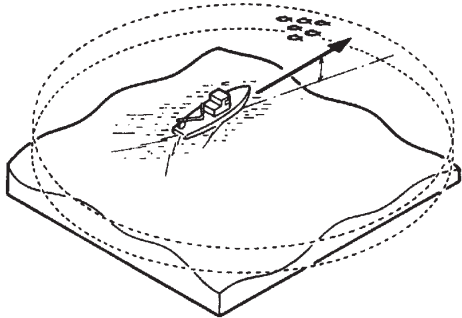

Bottom echo not displayed because of decreased tilt angle. Sea surface reflections are present.

(B) Midwater, bottom fish Tilt angle: 30° or more  
Fish echo which appears before bottom can be detected.

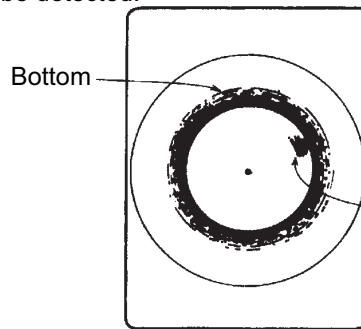
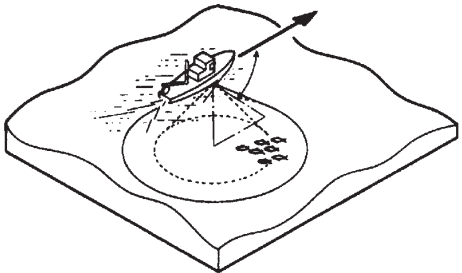

School of fish  
Bottom echo clearly displayed.

Tilt angle: 0° to 20°  
Fish echo which appears together with or after bottom can be detected.

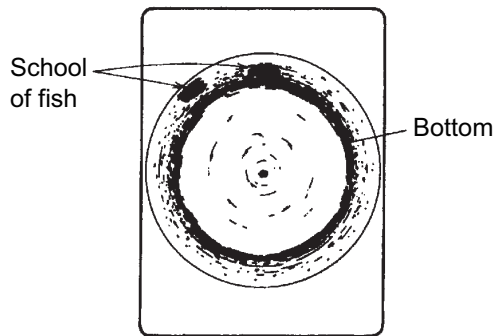
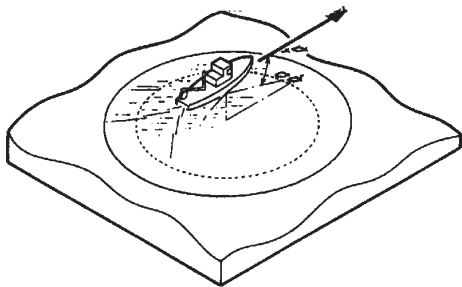

When the tilt angle is shallow, the reflection echo from bottom is weak and the fish echo that appears from bottom is easy to find.

### 2.23.2 Unnecessary echoes

#### Sea surface reflections

To reduce sea surface reflections, set the tilt angle to 4° or higher, so the upper edge of the sonar beam does not hit the sea surface, or adjust near gain. When a decreased tilt is used, sea surface reflections cover a large area as illustrated below.

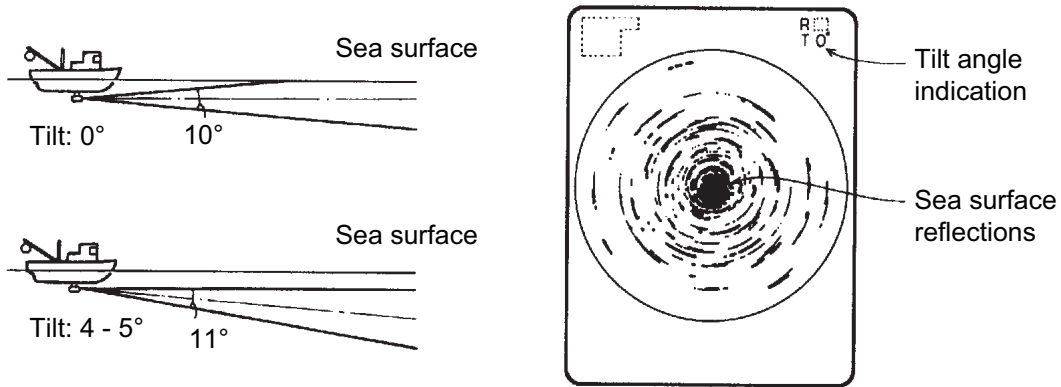

#### Wake

A wake produced by own ship or another ship can be a strong reflecting object when a decreased tilt angle is used. As the wake appears as a thick continuous line, it can be easily distinguished from a school of fish. A wake contains many air bubbles which attenuate ultrasonic energy, making it difficult to sound beyond the wake.

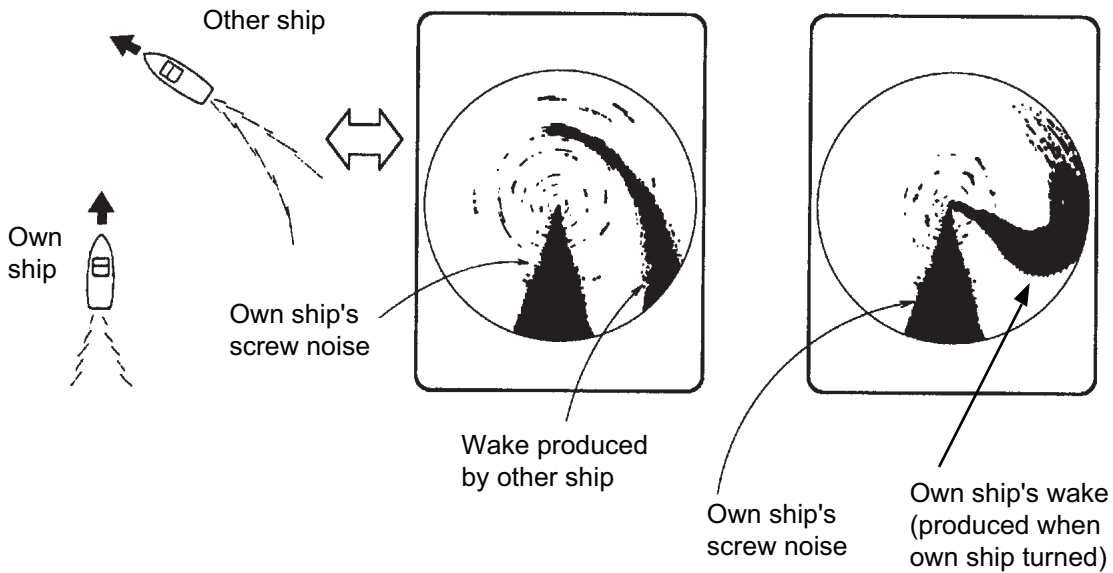



### **Noise and interference**

When the fishing ground is crowded with many fishing boats, the sonar is subject to interference from ultrasonic equipment (echo sounder or sonar) on other boats as well as those on own ship.

For instance, interference from the sonar operated on other boats will show itself on the display as in (A) in the figure below. This interference can be suppressed by changing the TX interval, with [TX Interval] on the [H-Scan Setting] menu. Noise from marine life shows itself on the displays as in (B) in the figure below. This type of noise can be suppressed with the interference rejector on the [Picture Setting] menu.

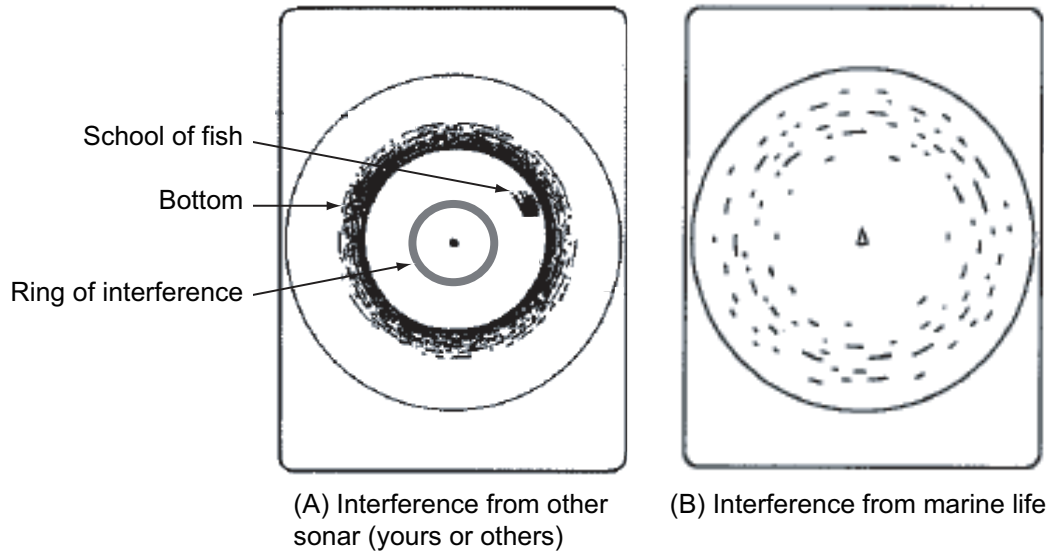

## 2. HORIZONTAL MODE

This page is intentionally left blank.

# 3. VERTICAL MODE

## 3.1 Basic Operating Procedure

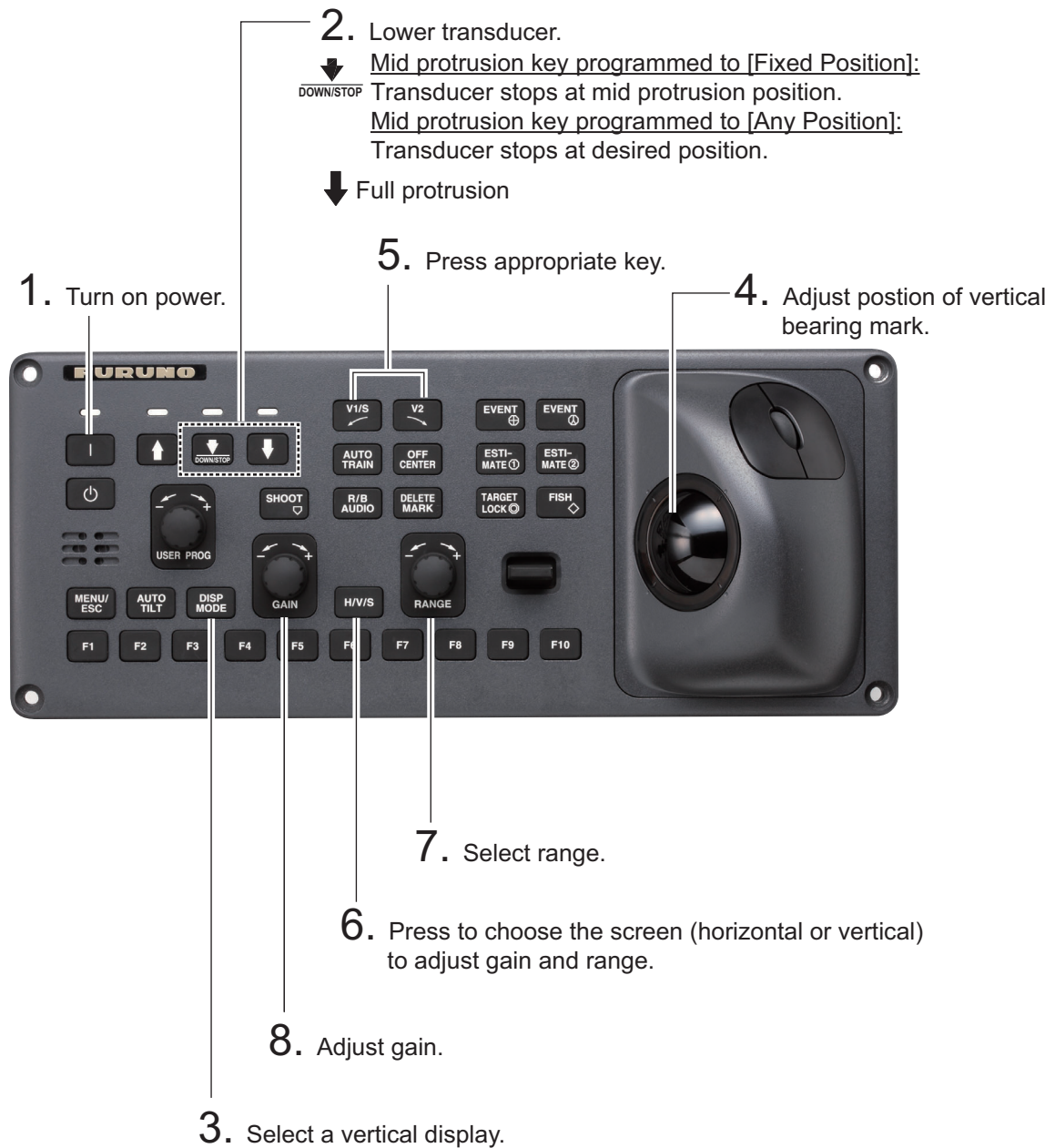

Control panel

## 3.2 How the Vertical Mode Works

### 3.2.1 Overview

The vertical mode shows a vertical section of the horizontal display selected with the vertical bearing mark. The figure below illustrates the concept of the vertical mode, in comparison with the horizontal mode. The vertical mode helps you keep fast moving fish such as bonito and tuna within the sonar beam.

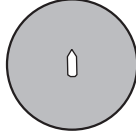
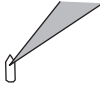
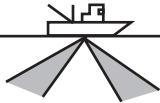
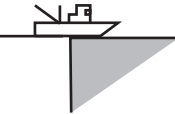
	Horizontal Mode	Vertical Mode
Detection aspect, view from top		
Detection aspect, view from side		

### 3.2.2 How to set the vertical display

1. Press the **MODE** key to select [H1] or [H2].
2. Use the trackball to place the cursor at the desired location in the horizontal display.
3. Press the **V1/S** or **V2** key.

For example, press the **V1/S** key. Then, the Vertical 1 display appears, and the vertical bearing marker is displayed in the horizontal display, with V at the tip of the marker as shown on page 3-3. If both vertical displays are activated 1 or 2 is inscribed at the tip of a vertical bearing marker.

**Note 1:** The vertical bearing can also be adjusted from the range indication. Put the cursor on the vertical bearing indication to highlight it in yellow then roll the scrollwheel.

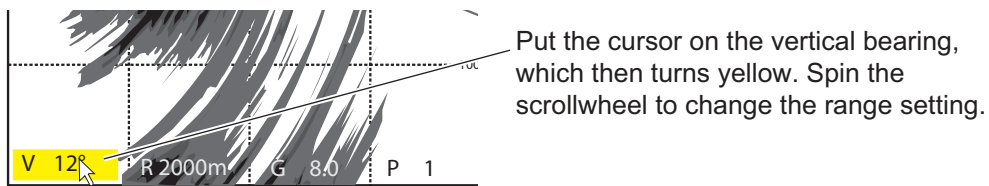

**Note 2:** The **TILT** control functions as a bearing setting lever for the vertical display1 in the conditions mentioned below. The bearing of the vertical display1 changes clockwise when the **TILT** control is pressed upward and counterclockwise when pressed downward, changing in increments of two degrees.

- The item [Tilt Lever] in the [Display Setting] menu is set to [TILT & V1].
- The vertical screen is chosen in the vertical 2 mode.

### 3.3 Vertical Indications and Marks

#### 3.3.1 Typical vertical display

The vertical mode provides a vertical section of the horizontal picture. You may show the display on the right or left side of the screen in case of the vertical 1 mode. An expansion mode is available to enlarge the picture. To display the vertical mode, press the **DISP MODE** key and choose V1 or V1 & V2. The example below shows the V1 mode. You can move and change the window size of the vertical display 1 by drag and drop.

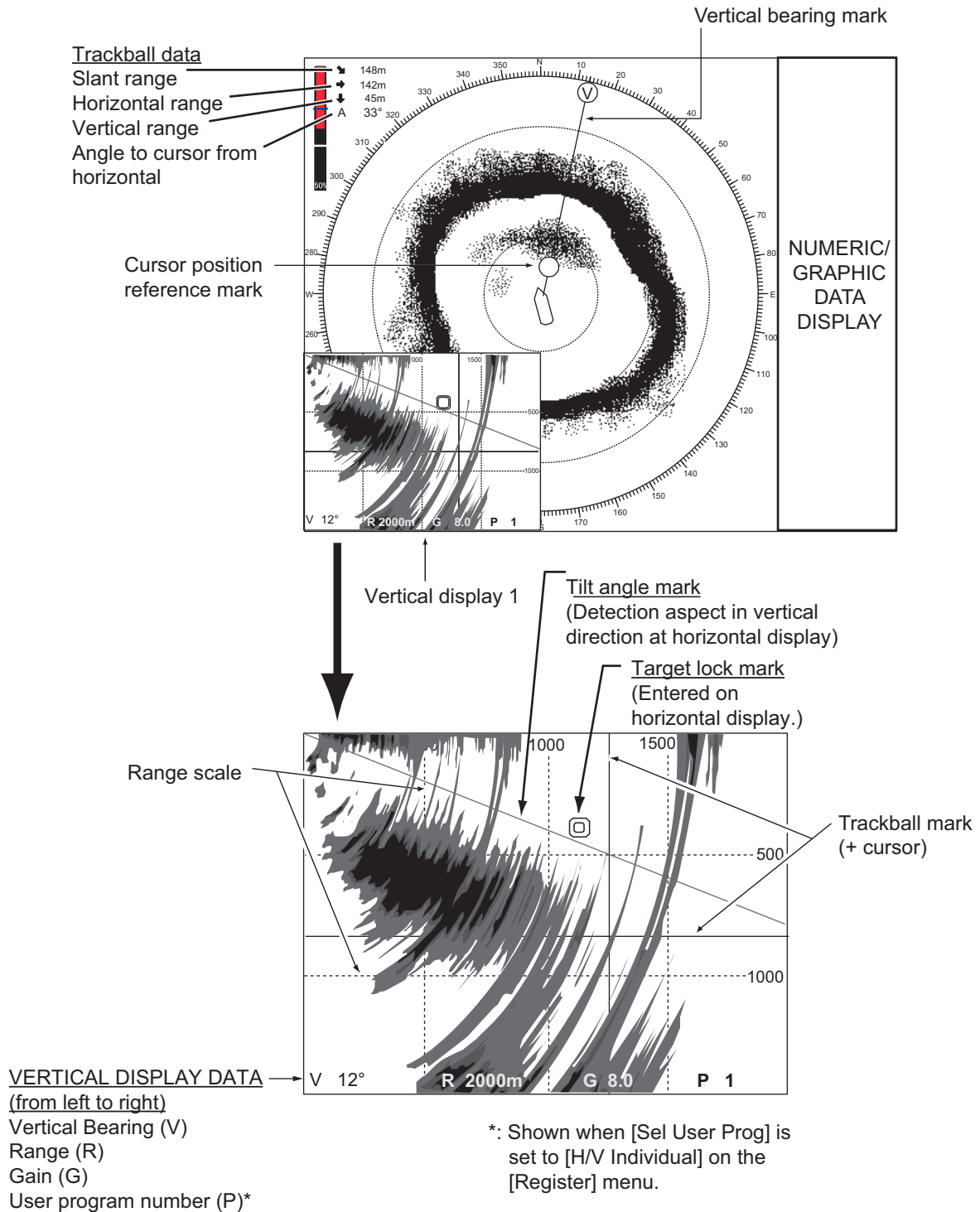

### 3. VERTICAL MODE

**Note:** When the settings listed below are changed, the setting value is shown at the top of the display for five seconds.

- Gain (See section 1.8.)
- Vertical bearing (See paragraph 3.2.2.)
- User program (See section 5.3.)
- Display range (See section 3.5.)
- Auto train (See section 3.4.)

#### 3.3.2 Vertical bearing mark, tilt mark

The vertical bearing mark is displayed with solid and dashed lines and it shows the bearing selected on the horizontal display. The circle at the top of the vertical bearing mark has a V inside of it in the vertical 1 mode, or 1 and 2 as appropriate when both the vertical 1 and vertical 2 modes are active. Its bearing may be referenced to North (true) or ship's heading (relative, default setting) on the menu. (See page 6-3.)

The tilt mark is a solid and dashed line which shows in the vertical display the tilt angle set on the horizontal display.

The meaning of the solid and dashed lines are as shown in the table below.

	Solid line	Dash
Vertical bearing mark	Range from own ship to vertical scan range	Range further than vertical scan range
Tilt mark	Range from own ship to horizontal scan range	Range further than horizontal scan range

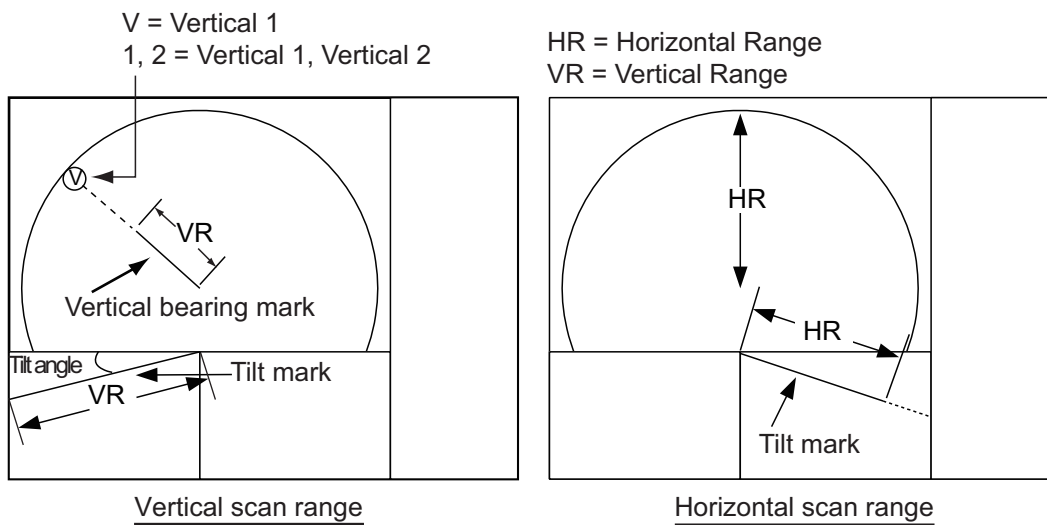

### 3.3.3 Cursor position reference mark

The cursor position reference mark, a solid circle, is inscribed on the vertical bearing mark when the cursor is placed in the vertical display. Its purpose is to show corresponding cursor position on the horizontal display. It changes position with cursor position, tilt and range, and disappears when its position is no longer within the range of the horizontal display.

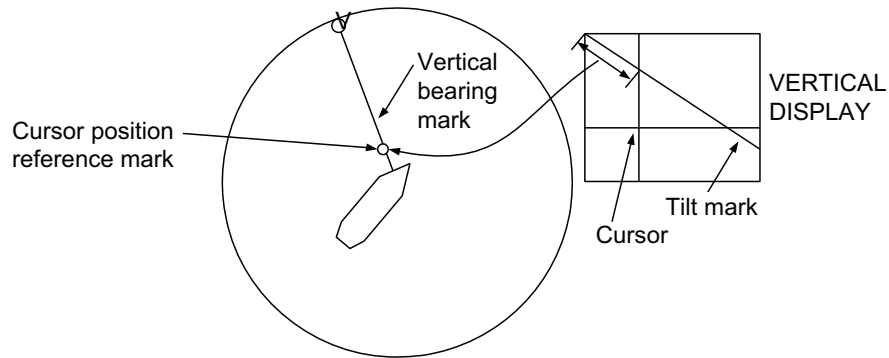

## 3.4 Auto Train

You may scan the vertical bearing mark in the sector of  $\pm 12^\circ$ ,  $\pm 24^\circ$  and  $\pm 36^\circ$ . Press and hold down the **AUTO TRAIN** key while pressing the **V1/S** or **V2** key to select the auto train sector desired. Selected sector appears in large characters for five seconds for your confirmation. To cancel auto train, repeat the above procedure to select [OFF].

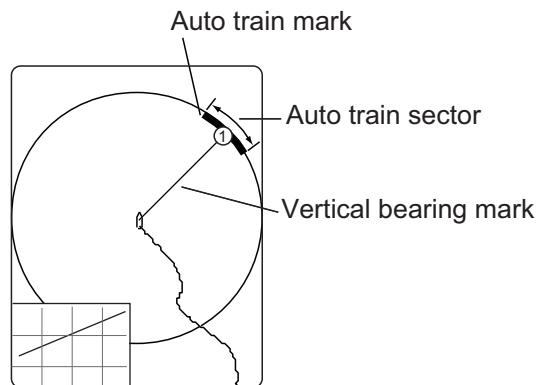

**Note:** If both the auto train and the target lock are active in a vertical mode, the following restrictions apply:

- V1 mode: Auto train is disabled.
- V2 mode: The auto train for the vertical bearing marker is disabled.

Disable the target lock to restore the auto train.

### 3.5 Display Range

The **RANGE** control selects the detection range. The range selected is momentarily displayed in large characters at the top of the vertical 1 display. Range is always displayed next to "R" at the lower part of the vertical 1 display.

The default ranges are as shown below. In the vertical 2 combination display, the range for V1 and V2 are same.

Range No.	1	2	3	4	5	6	7	8
Detection range	200	400	600	1000	1600	2000	3000	4000

**Note:** Ranges can be preset. See page 6-6 for details.

1. Press the **H/V/S** key to show the range and gain indications of the horizontal mode to change the range (and gain). The indication color of the range and gain are changed to orange.
2. Operate the **RANGE** control to select a range.

**Note:** The range can also adjusted from the range indication. Put the cursor on the range indication to highlight it in yellow then roll the scrollwheel.

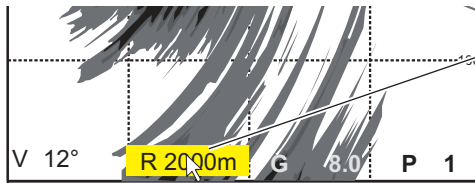

Put the cursor on the range setting, which then turns yellow. Spin the scrollwheel to change the range setting.

### 3.6 How to Measure the Range, Bearing to a Target

Operate the trackball to place the cursor on the vertical 1 (or vertical 2) display. The range to the location selected is shown at the top left corner.

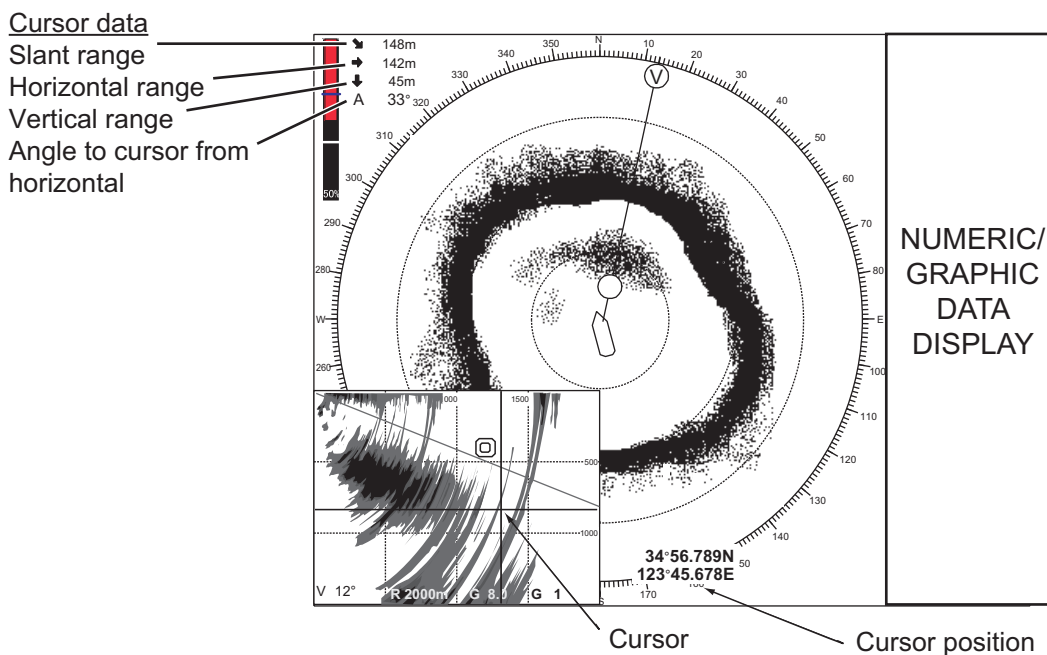

**Note:** To show the cursor position in L/L, see page 6-12.



## 3.7 How to Eliminate Weak Echoes

Echoes from targets such as bottom and fish return to the transducer in order of distance to them, and when we compare their intensities at the transducer face, those from nearer targets are generally stronger due to little propagation attenuation and little absorption. If these echoes are displayed directly on the screen, the size of the displayed echo from the same school of fish may change with distance, making it difficult to judge the actual size of the school of fish. To overcome this inconvenience use the TVG curve function. It compensates for propagation loss of sound in water; amplification of echoes on short range is suppressed and gradually increased as range increases so that similar targets are displayed in the similar intensities irrespective of the ranges to them.

### 3.7.1 Change sensitivity of TVG curve

Four TVG curves are available and they vary the gain from large to small.

1. Press the **MENU/ESC** key to open the main menu.
2. Click [Gain Setting].
3. Press the **H/V/S** key to select the [V] tab.

Gain Setting		Quit
H1 P1	H2 P1	V P1
TVG Curve	:	15Log
Near Gain	:	5.0
Near Gain Distance	:	400m
Far Gain	:	5.0
Far Gain Distance	:	400m
AGC Near	:	4.0
AGC Far	:	4.0
AGC Distance	:	20m
Noise Suppress	:	2.0
Noise Supp. (SHIP)	:	0.0

4. Click [TVG Curve].
5. Click ▲ or ▼ to select a suitable Log value.  
The smaller the number, the gentler the gain changes over distance.
6. Click [Quit] on the setting box to close the box.
7. Long-push the **MENU/ESC** key to close all menus.

The TVG is also used to suppress unwanted echoes (sea surface reflections, cruising noise, etc.) on near ranges. If the selected curve does not provide satisfactory results, see section 3.7.2 for how to adjust near gain and far gain.

Quit
Cancel
▲
2
▼
(0.0~10.0)

### 3.7.2 Change near gain, far gain

This sonar lets you adjust near gain and far gain separately.

1. Press the **MENU/ESC** key to open the main menu.
2. Click [Gain Setting].
3. Press the **H/V/S** key to select the [V] tab.
4. Click [Near Gain Distance] or [Far Gain Distance].
5. Click ▲ or ▼ to select a suitable value.
6. Click [Quit].
7. Click [Near Gain] or [Far Gain].

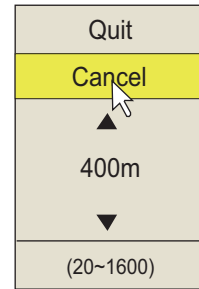

**[Near Gain]:** Adjust sensitivity in area closer than [Near Gain Distance].

**[Far Gain]:** Adjust sensitivity in area further than [Far Gain Distance].

8. Click ▲ or ▼ as appropriate then push the left button.  
The setting range is 0.0 to 10.0. Setting "5" does not correct the gain. Use a setting lower than 4 to lower the gain, or use a setting higher than 5 to raise the gain.
9. Click [Quit] on the setting box to close the box.
10. Long-push the **MENU/ESC** key to close all menus.

## 3.8 How to Adjust Strong, Weak Echoes

### 3.8.1 AGC Near, AGC Far, AGC Distance

The AGC function automatically reduces the receiver gain only against strong echoes such as the bottom or a large school of fish. Since the AGC function does not affect weak echoes, a small school of fish becomes easier to detect. The FSV-25 has three types of AGC settings, [AGC Distance], [AGC Near], and [AGC Far]. Adjust them so that the AGC works only on bottom reflections. Do not set it too high; weak echoes may be missed.

1. Press the **MENU/ESC** key to show the main menu.
2. Click [Gain Setting].
3. Press the **H/V/S** key to select the [V] tab.
4. Click [AGC Distance] to show the setting box.
5. Click ▲ or ▼ to change the setting.  
The setting range is 20 - 5000 m, in 20 m increments.
6. Click [Quit] on the setting box to close the box.
7. Click [AGC Near] or [AGC Far] to show the setting box.

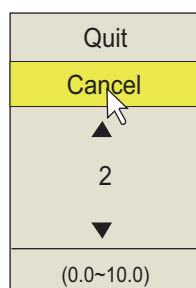
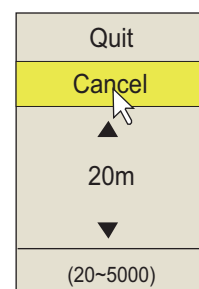

[AGC Near]: Suppress gain in area closer than the [AGC Distance] setting.  
 [AGC Far]: Suppress gain in area that is beyond the [AGC Distance] setting.

8. Click ▲ or ▼ to change the setting.  
The setting range is 0.0 - 10.0. The larger the figure the greater the degree of suppression. However, too high a setting may erase weak echoes.
9. Click [Quit] on the setting box to close the box.
10. Long-push the **MENU/ESC** key to close all menus.

### 3.8.2 How to shorten pulse length

The pulse length determines the length of the transmission pulse emitted into the water. While a longer pulse is advantageous for long-range sounding, it has the disadvantage of being poor in discrimination of targets, that is, the ability to separate several closely located targets. When searching bottom fish, therefore, it is useful to shorten the pulse length in order to separate fish echoes from bottom reflections. Decrease the pulse length setting to shorten the pulse length.

**Note:** For search of surface and midwater fish in which bottom reflections are not so strong, use the longest pulse length 9.

1. Press the **MENU/ESC** key to show the main menu.
2. Click [TX/RX Setting].
3. Press the **H/V/S** key to select the [V] tab.
4. Click [TX Pulse Length].
5. Click ▲ or ▼ to change the setting.  
The setting range is 0-9. The higher the setting, the longer the pulse length.
6. Click [Quit] on the setting box to close the box.
7. Long-push the **MENU/ESC** key to close all menus.

TX/RX Setting		Quit
H1 P1	H2 P1	V P1
TX Interval	:	9
TX Pulse Length	:	9
TX Power	:	9
Reverberation	:	0
Freq Shift	:	0
Hor. Beam Wid	:	4
Ver. Beam Wid	:	4

### 3.8.3 How to suppress unwanted echoes

This sonar's noise suppressor removes weak echoes such as sea surface reflections and echoes from plankton. Because the noise suppressor does not work against strong echoes it is useful for detecting schools of fish.

1. Press the **MENU/ESC** key to show the main menu.
2. Click [Gain Setting].
3. Press the **H/V/S** key to select the [V] tab.
4. Click [Noise Suppress] to show the setting box.
5. Click ▲ or ▼ to change the setting.  
The higher the setting, the higher the degree of suppression.
6. Click [Quit] to close the box.
7. Long-push the **MENU/ESC** key to close all menus.

Quit
Cancel
▲
2
▼
(0.0~10.0)

## 3.9 How to Reject Sonar Interference and Noise

While observing the sonar picture, you may encounter occasional or intermittent noise and interference. These are mostly caused by on-board electronic equipment, engine or propeller noise, or electrical noise from other sonars being operated nearby.

### 3.9.1 How to identify the noise source

To eliminate noise effectively, you should first identify the noise source as follows:

1. On the [Test] menu, turn off [TX] to stop transmitting. Turn on all on-board electronic equipment one by one while observing the picture. If noise appears on the sonar display, that equipment is emitting noise. Check the offending equipment's ground and installation.
2. Run the boat at various speeds to check if the noise is speed dependent.

If neither of the above two steps has effect on the picture, adjust one of the following:

### 3.9.2 Interference rejector

The interference rejector suppresses randomly appearing noise, sea surface reflections, and interference from other acoustic sounding equipment. Set it so that noise is just eliminated. Do not use an unnecessarily high setting since it may also reject small, wanted echoes.

1. Press the **MENU/ESC** key to show the main menu.
2. Click [Picture Setting].
3. Press the **H/V/S** key to select the [V] tab.
4. Click [Int Reject] or [Int Reject (ES)].
  - [Int Reject]: Use this item to suppress sea surface reflections, and sea surface reflections.
  - [Int Reject (ES)]: Use this item to suppress interference from other acoustic sounding equipment.
5. Click ▲ or ▼ to change the setting.
  - [Int Reject]: The setting range is 0 to 3. The degree of rejection in ascending strength is 2, 1, 3. "0" disables the interference rejector.
  - [Int Reject (ES)]: Use this item to suppress interference from other acoustic sounding equipment. The degree of rejection in ascending strength is 1, 2, 3. "0" disables the interference rejector.
6. Click [Quit] on the setting box to close the box.
7. Long-push the **MENU/ESC** key to close all menus.

Picture Setting		Quit
H1 P1	H2 P1	V P1
Echo Average	:	3
Int Reject	:	2
Int Reject (ES)	:	2
Smooth Echo RNG	:	2
Smooth Echo CIR	:	0
2nd Echo Rej.	:	0

### 3.9.3 Shift TX frequency

If the interference can not be suppressed by the interference rejector or change in TX interval, shift the Tx frequency with the [Freq Shift] menu.

1. Press the **MENU/ESC** key to show the main menu.

2. Click [TX/RX Setting].
3. Press the **H/V/S** key to select the [V] tab, then click [Freq Shift].
4. Click ▲ or ▼ to change the setting. The setting range is -20 to 20.
5. Click [Quit] on the setting box to close the box.
6. Long-push the **MENU/ESC** key to close all menus.

### 3.9.4 Noise limiter

Weak, unwanted reflections, colored light-blue or green, appear when the water is dirty, plankton layers exists, or due to ship's noise. The noise limiter can reduce the effects of these unwanted reflections. Raising the setting causes unwanted reflections to be displayed in colors of blue to background color.

1. Press the **MENU/ESC** key to show the main menu.
2. Click [Display Setting].
3. Press the **H/V/S** key to select the [V] tab.

Display Setting

Quit

H1 P1 H2 P1 V P1

Noise Limiter : 0 Color : Color1

Signal Level : 4 Color Response : Color Curve1

V-Scan Color1 Setting V-Scan Color Curve1 Setting

Default Cancel Apply

Undo Redo Switch

Default V1copy Cancel Apply

### 3. VERTICAL MODE

- Click [Noise Limiter].
- Click ▲ or ▼ to change the setting (setting range: 0 to 10). The higher the setting, the greater the degree of the suppression.
- Click [Quit] on the setting box to close the box.
- Long-push the **MENU/ESC** key to close all menus.

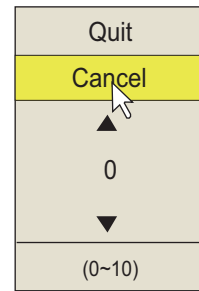

### 3.9.5 Reverberation

You can reduce the strength of reverberation from sea-surface, sea-bottom and plankton layer, with [Reverberation] on the [TX/RX Setting] ([V] tab). The setting range is 0 to 3. The reverberation setting is automatically set to “0” when the range is 100 m or less. The larger the setting, the greater the reduction in reverberation. Select a value that reduces reverberation while showing echo signals clearly.

### 3.9.6 Echo average

[Echo Average] on the [Picture Setting] menu in the [V] tab adjusts echo afterglow - the amount of time an echo signal remains on the screen. This feature can be useful for watching echo movement. The setting range is 0 to 11.

**Setting between 1 and 7:** Echoes are gradually displayed and afterglow remains on the screen longer as the setting is increased.

**Setting between 8 and 11:** Echoes are quickly displayed and afterglow remains on the screen longer as the setting is increased.

## 3.10 How to Adjust Beam Width

The width of the horizontal and vertical beam can be adjusted from the [TX/RX Setting] menu.

- Press the **MENU/ESC** key to show the main menu.
- Click [TX/RX Setting].
- Press the **H/V/S** key to select the [V] tab, then click [Beam Width].

TX/RX Setting		Quit
H1 P1	H2 P1	V P1
TX Interval	: 9	
TX Pulse Length	: 9	
TX Power	: 9	
Reverberation	: 0	
Freq Shift	: 0	
Hor. Beam Wid	: 4	
Ver. Beam Wid	: 4	

- Click [Hor. Beam Wid] or [Ver. Beam Wid] as appropriate.
- Click ▲ or ▼ to set the beamwidth. The higher the setting the sharper the beamwidth.
- Click [Quit] on the setting box to close the box.
- Long-push the **MENU/ESC** key to close all menus.

## 3.11 Other Menu Items

This section describes menu items which have not been explained yet.

### Display Setting menu

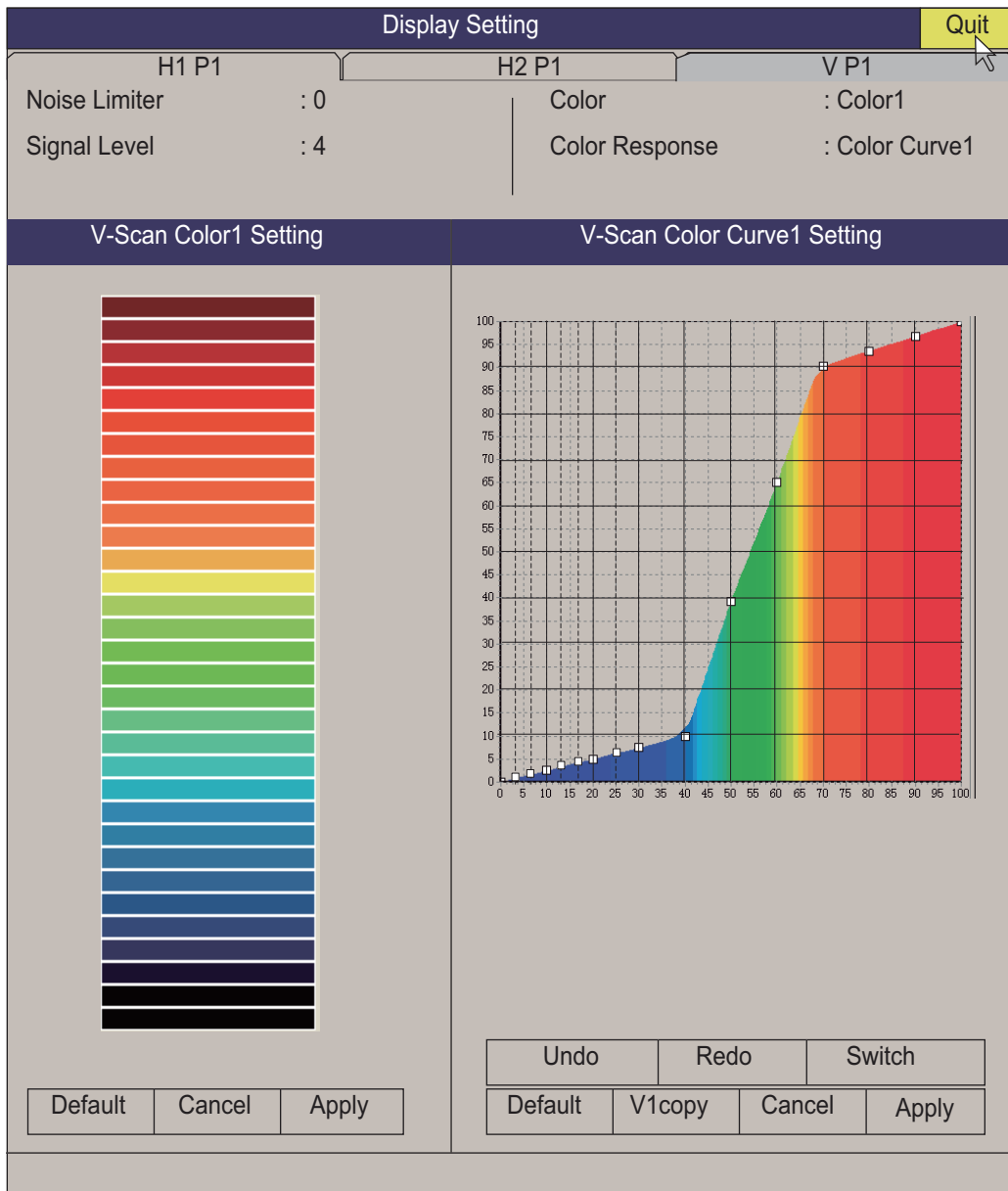

**[Signal Level]:** Contaminated water or reflections from plankton may be painted on the screen in green or light-blue. These echoes may be erased in order of strength. The setting range is 0-31; 0 corresponds to the weakest color.

**[Color]:** Select color arrangement to use.

**[V-Scan Color 1 (2 to 4) Setting]:** Customizes colors. For details, see page 2-37.

**[V-Scan Color Curve Setting]:** Adjusts reflected echo strength versus echo color level for currently selected color response number. To adjust the curve, see page 2-37.

### 3. VERTICAL MODE

#### Picture Setting menu

Picture Setting		Quit
H1 P1	H2 P1	V P1
Echo Average	: 3	
Int Reject	: 2	
Int Reject (ES)	: 2	
Smooth Echo RNG	: 2	
Smooth Echo CIR	: 0	
2nd Echo Rej.	: 0	

**[Smooth Echo RNG]:** Selects echo smoothing level in the range direction. The setting range is 0 to 5. The higher the setting, the greater the smoothing.

**[Smooth Echo CIR]:** Selects echo smoothing level in the circular direction. The setting range is 0 to 4. The higher the setting, the greater the smoothing.



# 4. NUMERIC/GRAPHIC DATA DISPLAY

## 4.1 Numeric/Graphic Data Display

This display provides comprehensive numeric/graphic data and appears with the horizontal and vertical displays, at the right side of the display.

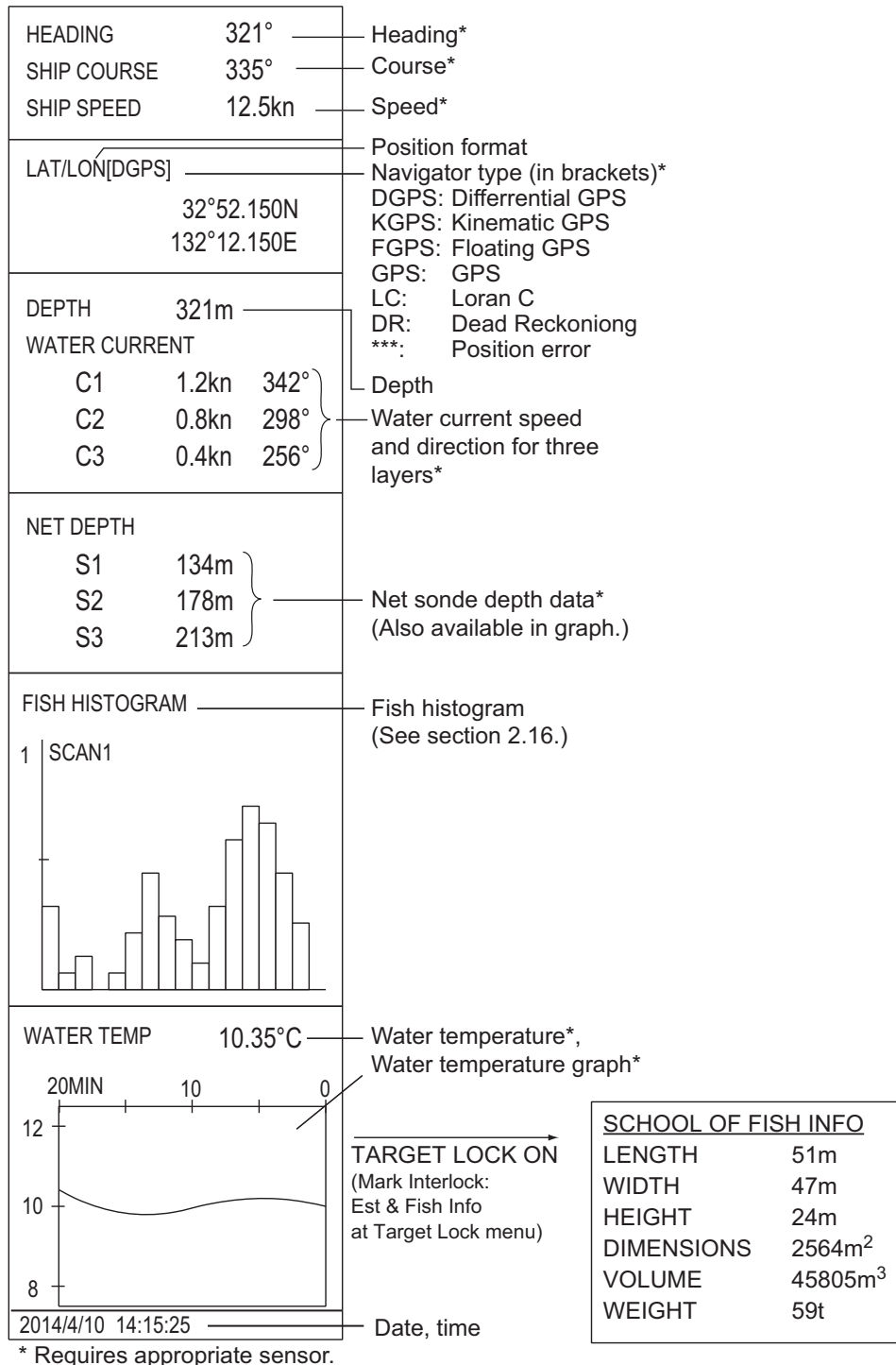

\* Requires appropriate sensor.

## 4.2 Numeric, Graphic Data Description

When a data is lost its last-entered value is shown in red. Data displays can be turned on or off through the [DATA DISPLAY] menu.

Numeric/ Graphic item	Description	Display range	Available formats	Where to change format
Heading	Shows heading input from heading sensor.	32 compass pts. 0° to 359° 1° to 179° P/S, 0°, 180°	32 compass pts. 360° True 360° Rel 180° Rel	[Data Display] menu
Course	Shows ship course fed from numeric/graphic indication.			
Speed	Shows ship speed fed from a Numeric/graphic indication.	0 to 40 kn	Fixed at knots	
Position of the ship	Ship position in latitude and longitude. If position data is lost the last-entered position is shown in red.	Lat: 90°00.000S to 90°00.000N Lon: 179°59.999W to 179°59.999E, 180°00.00, 0°00.000	Lat/Lon	
Position sensor	The position sensor type is displayed in brackets ("[]"). When the position sensor is not connected, the brackets are left blank.	DGPS, KGPS, FGPS, GPS, LC, DR, *** <b>Note:</b> "****" is displayed when the positioning error occurs.	GPS Loran-C DR AUTO	System menu
Depth	Shows depth from transducer to bottom.	0 to 9999 m	Meters	
Current	Shows tide speed and direction for three layers or tide and speed for two layers against a reference layer fed from a current indication.	Cur. Spd: 0 to 9.9 kn Direction: 0° to 359°	Direction shown as flow from or flow to	[Current Vec & Wind] menu
Net depth	Depth of net sonde transmitter. Shown only at shooting of net.	0 to 999 m	Depth of up to 3 pts. can be displayed.	[Net SONDE Setting] menu

Numeric/ Graphic item	Description	Display range	Available formats	Where to change format
Fish histo- gram	Shows signal strength concentration of fish estimate mark inscribed on horizontal display.	Two marks	On/Off on the [Mark Display] - [Histogram Disp.] menu	
Water temp.	Shows water temperature input from a temperature sensor.	-10.00°C to +40.00°C, 14.00°F to 104.00°F	°C, °F	[Data Display] menu
Water temp. graph	Shows water temperature over time. Horizontal axis: time, Vertical axis: °C(°F)	Horizontal axis: Time 20 min./1h/6h/12h/24h, Vertical axis: Temp. 4°C, 8°F, fixed width, auto shift)	°C, °F	[Data Display] menu
Info on school of fish	Shows information about school of fish during target lock operation.	<b>Length:</b> Distance to school of fish in range direction <b>Width:</b> Distance to school of fish in bearing direction <b>Height:</b> Vertical distance <b>Dimensions:</b> Horizontal dimension of school of fish <b>Volume:</b> Estimated volume of school of fish <b>Weight:</b> Estimated tonnage of school of fish, calculated from dimension or volume above		
Date, time	Current date and time			[Initial Settings] menu

#### 4. NUMERIC/GRAPHIC DATA DISPLAY

This page is intentionally left blank.

# 5. HOW TO CUSTOMIZE THE SONAR

## 5.1 User Menu

You may program 20 often-used menu items to the user menu area in the menu. The default arrangement has TX pulse length, TX power, color, color response and echo average programmed to the horizontal scan1 display.

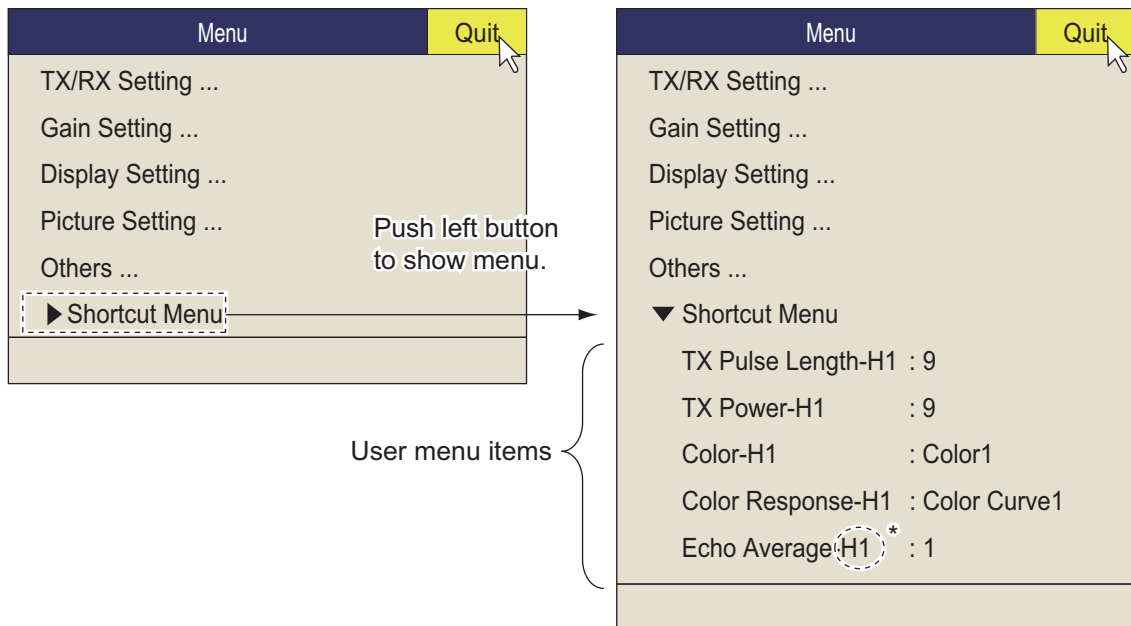

\*: Item programmed to tab H1. H2 for H2 tab; V for V tab.

### 5.1.1 How to program the user menu

The procedure below shows you how to add the menu item [V Mode] (on the [Wheel Setting] menu) to the user menu. Some menu items can not be programmed to the user menu. See the menu tree on page AP-1 to AP-5 for items which can be programmed.

1. Push the right button on the numeric/graphic data display to show the pop-up menu.
2. Click [Wheel Setting].

Wheel Setting		Quit
H Mode	: Tilt Angle	
V Mode	: Bearing	
Wheel	: Reverse	

## 5. HOW TO CUSTOMIZE THE SONAR

3. Click [V Mode] more than one second. The message window shown below appears.

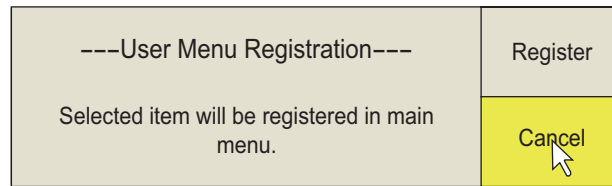

4. Click [Register].  
The selected item is registered, and shown at the bottom of the menu. The order of items in the [USER] menu can be changed by drag and drop.  
**Note:** If 20 items are already registered to the user menu the following message appears. Delete unnecessary items from the user menu and then repeat this procedure to register different item. Press the **MENU/ESC** key to close this message.

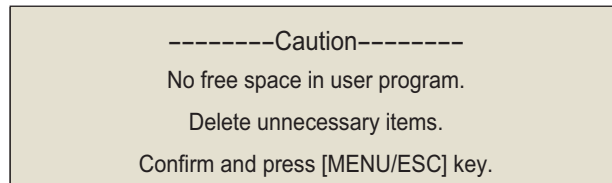

5. Long-push the **MENU/ESC** key to close all menus.

### 5.1.2 How to remove items from the user menu

You can remove items from the user menu.

1. Press the **MENU/ESC** key to open the main menu.
2. Click [▼ Shortcut Menu].
3. Click the item to delete then push the left button more than three seconds. The message window shown below appears.

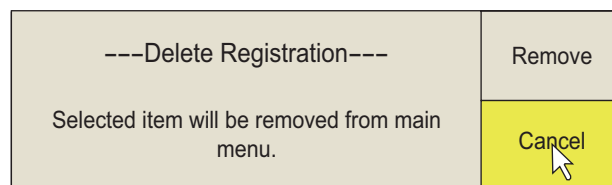

4. Click [Remove] to delete.
5. Long-push the **MENU/ESC** key to close all menus.

## 5.2 Function Keys (F1 to F10)

The function keys provide one-touch display of desired menu item or entire menu. The default function key settings are as below. Not all menu items and menus may be programmed to the function keys. See the menu tree on page AP-1 to AP-5 for items which may be programmed.

Function key	Default setting	Function
F1	Record Still Image	Save the still image
F2	Play Still Image	Open the [Still Image] window
F3	Event Mark 1	Erase event mark 1
F4	Event Mark 2	Erase event mark 2
F5	Fish Mark	Erase fish mark
F6	Own Ship Pos Mark	Erase own ship position mark
F7	Ship's Track	Erase approx. 10% of the ship's track
F8	Stabilization	Activate or deactivate the stabilization
F9	Net Course Mark	Enter or erase the net course mark
F10	Gain Knob Setting	Change function of <b>GAIN</b> control. See page 6-4.

### 5.2.1 How to execute a program

1. Press desired function key to show the applicable dialog box.

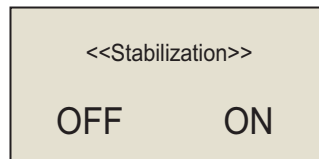

*When the F8 key is pressed*

2. Press the same function key again within five seconds to execute the function. The dialog box automatically disappears in five seconds. You can also close the dialog box manually by pressing any function key other than the one pressed at step 1.

### 5.2.2 How to program the function keys

You can change the default setting of a function key as shown below.

**Note 1:** Note that some menu items can not be programmed to the function keys. See the menu tree on page AP-1 to AP-5 for items which can be programmed for function keys.

**Note 2:** Some menu items are shown in red. This means these items are locked to prevent accidental change of setting (see page 1-15). However these items can be programmed to the function key, the confirmation message does not appear when you execute a program with the function key.

1. Press the **MENU/ESC** key to open the menu and select desired menu item. When you want to assign the timer function to the function key, click the timer indication ("00:00:00") on the timer window.

**Note:** Set [Timer Display] to [ON] on the [Display Setting] menu to show the timer window (see page 6-4).

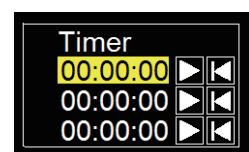

## 5. HOW TO CUSTOMIZE THE SONAR

2. Press desired function key for more than one second. The message shown below appears for five seconds.

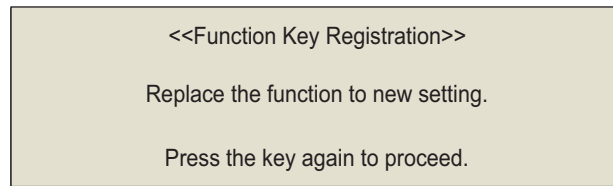

3. Press the same function key again, and the message shown below appears.

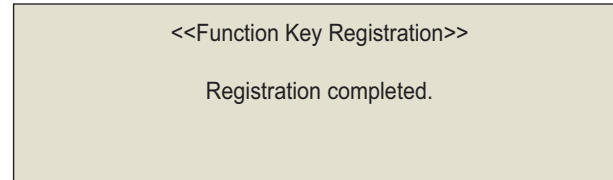

After registration is completed, the number of the function key appears on the left of the menu item or timer indication.

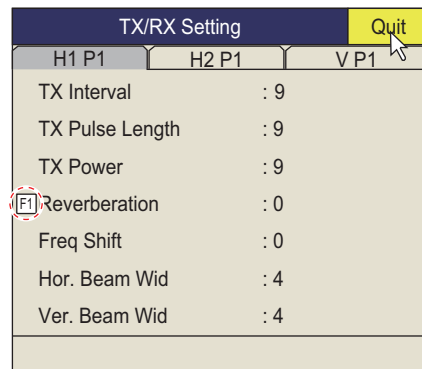

Menu item

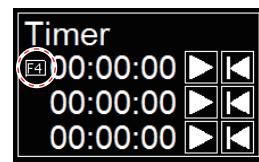

Timer indication

### 5.2.3 How to check function key programs

1. Press the **MENU/ESC** key to open the main menu.
2. Click [Others].
3. Click [Register].

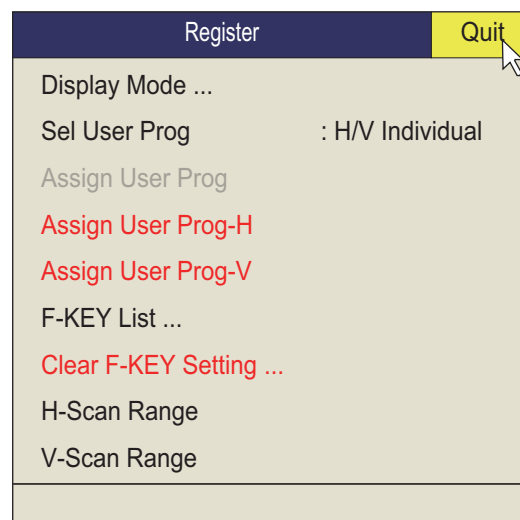



- Click [F-KEY List].

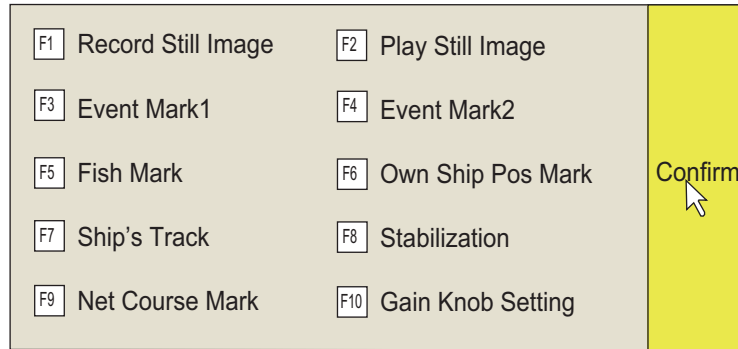

- Click [Confirm] to close the window.
- Click [Quit].
- Long-push the **MENU/ESC** key to close all menus.

### 5.2.4 How to erase programs

- Press the **MENU/ESC** key to open the main menu.
- Click [Others].
- Click [Register].

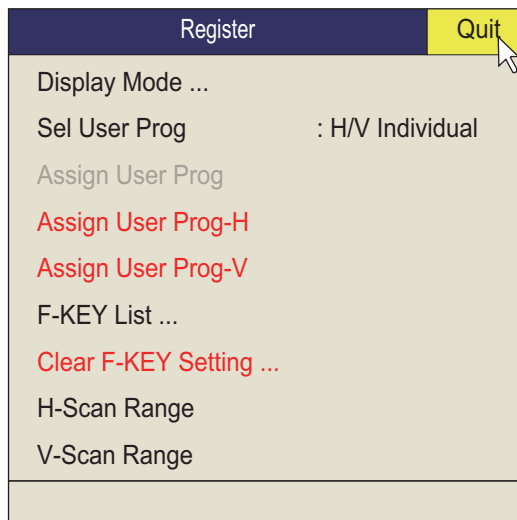

- Click [Clear F-KEY Setting].

## 5. HOW TO CUSTOMIZE THE SONAR

5. Click [Changeable].

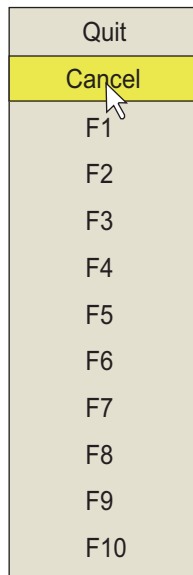

6. Click the function key for which you want to erase its program then push the left button. Repeat this step for other function keys.
7. Click [Quit] on the setting box to close the setting box.
8. Long-push the **MENU/ESC** key to close all menus.

### 5.2.5 How to program the function keys of remote controller

You can program the function keys (**F1-F4**) on the remote controller (option) to provide one-touch access to the functions of the keys on the control unit.

The function of the following control unit keys can be assigned to the function keys on the remote controller.

- **V1/S** key
- **V2** key
- **EVENT** ⊕ (or ⊗) key
- **OFF CENTER** key
- **ESTIMATE 1** (or 2) key
- **SHOOT** key
- **R/B AUDIO** key
- **DELETE MARK** key
- **TARGET LOCK** key
- **FISH** key
- **AUTO TRAIN** key
- **DISP MODE** key
- **H/V/S** key
- **F1 to F4** key

The default setting of the **F1** to **F4** key is the same as those on the control unit. To change a setting, do as follows:

1. Press the **F8**, **F9**, and **F10** keys in order while pressing the **MENU/ESC** key to activate the program registration mode on the remote controller.
2. Press the **MENU/ESC** key to close the menu.
3. Press and hold down the applicable key on the control unit and then press a function key on the remote controller.  
When the registration is completed the audio alarm sounds.
4. Operate the function key programmed to confirm functionality.
5. Repeat steps 1 to 4 to program another function key.

## 5.3 USER PROG Control

The **USER PROG** control provides for instant setup of the equipment according to fishing ground or target fish. Ten programs may be set up, and vertical and horizontal display settings may be programmed together or individually. (The default settings programs them together. For how to program them individually see section 5.3.2.)

### 5.3.1 How to select a user program

Rotate the **USER PROG** control clockwise or counterclockwise to select the program no. desired. The program no. selected appears at the top right-hand corner of the screen to the right of "P". If the equipment is turned off with a user program active, it starts up with those settings at the next power on.

**Note:** The user program no. can also be adjusted from the user program no. indication.

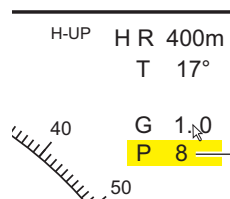

Put the cursor on the program setting, which is then highlighted in yellow. Spin the scrollwheel to change the setting.

### 5.3.2 How to program the USER PROG control

1. Set the display appropriately.  
When a combination mode is shown, press **H/V/S** key to select the display to program.
2. Press the **MENU/ESC** key to show the main menu.
3. Click [Others].
4. Click [Register].

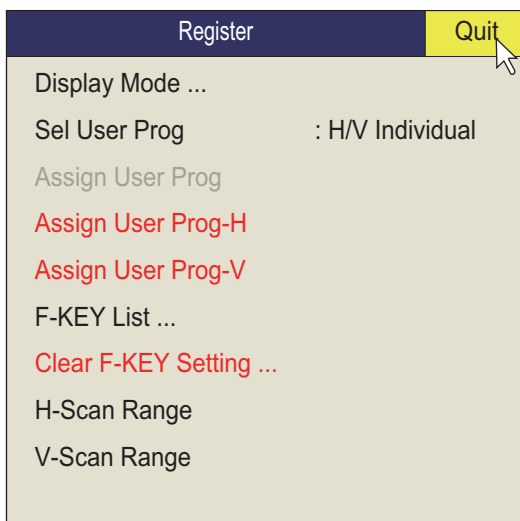

[Sel User Prog] = [H/V Individual]

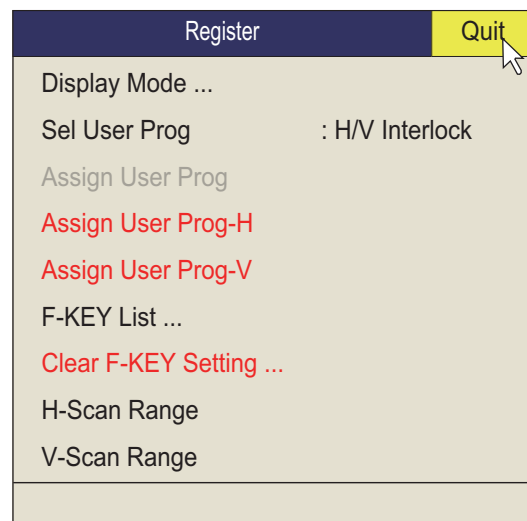

[Sel User Prog] = [H/V Interlock]

\*: H/V Interlock: Effective on both H and V displays.

H/V Individual: Select the display to use with the **H/V/S** key.

## 5. HOW TO CUSTOMIZE THE SONAR

5. Do one of the following then push the left button.
  - **For [H/V Interlock]:** Select [Assign User Prog].
  - **For [H/V Individual]:** Select Assign [User Prog-H/S] or [Assign User Prog-V].
6. Click [Changeable]. One of the following displays appears depending on your selection.

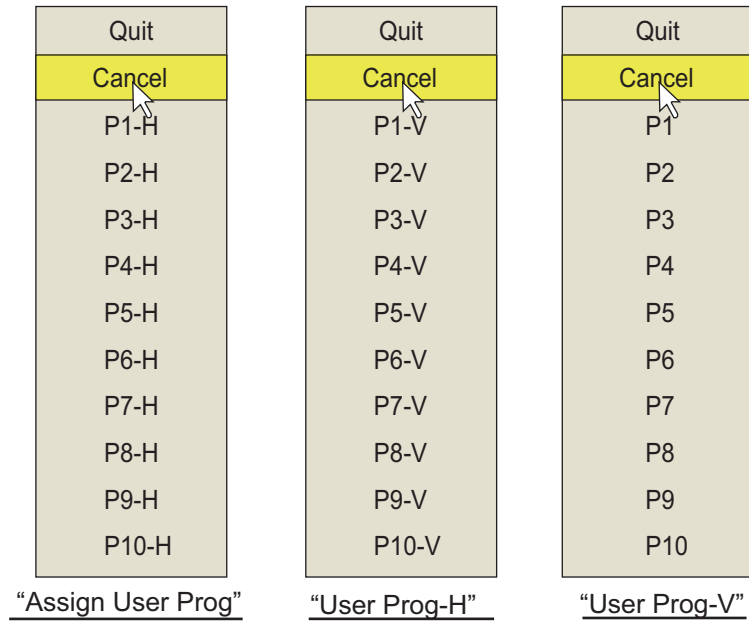

7. Click a program no.
8. Click [Quit] on the setting box to close the box.
9. Long-push the **MENU/ESC** key to close all menus.

## 6. OTHERS MENU

This chapter provides descriptions for the [Others] menu. To display the [Others] menu, press the **MENU/ESC** key then click [Others].



The [Record/Recall] menu is described in chapter 7. Also, menu items shown in gray can not be accessed.

### 6.1 Erase Marks Menu

The [Erase Marks] menu lets you delete selected marks and track.

1. Click [Erase Marks] on the [Others] menu  
This menu can be also opened from the right-click pop up menu.

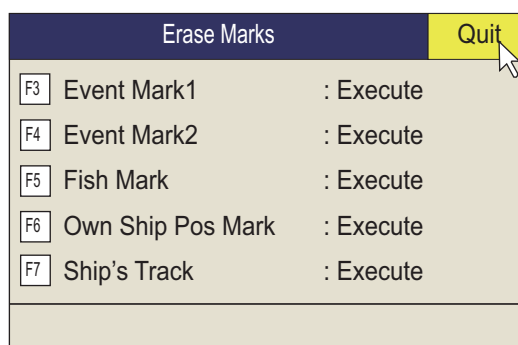

2. Click the mark (or track) you want to delete. The earliest mark is deleted. For ship's track, approximately 10% of the track is erased with each push of the left button.
3. To continue erasing marks, push the left button.
4. Long-push the **MENU/ESC** key to close all menus.

**Note:** The default function of the **F3** (for event mark 1), **F4** (for event mark 2), **F5** (fish mark) and **F6** (for own ship position) keys delete the oldest event mark, fish mark, own ship mark. The default function of the **F7** key erases approximately 10% of the track.

## 6.2 Wheel Setting Menu

Tilt angle (horizontal display only), range, gain, or bearing (vertical display only) can be assigned to the scrollwheel. Additionally, the direction of incrementation with scroll wheel operation also can be changed. (Applicable to tilt angle, detection range, gain, vertical bearing, user program number, and circle cursor diameter.)

1. Click [Wheel Setting] on the [Others] menu.  
This menu can be also opened from the pop-up menu.

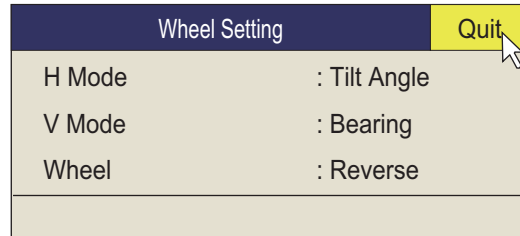

2. Click [H Mode] or [V Mode].

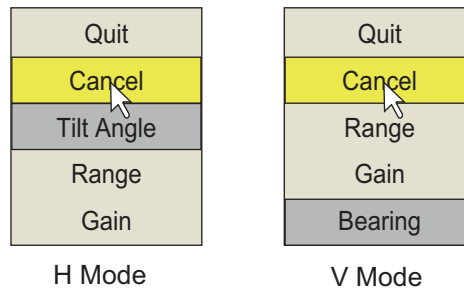

3. Click the function to assign to the scrollwheel.
4. Click [Quit] on the setting box to close the box.
5. Click [Wheel].

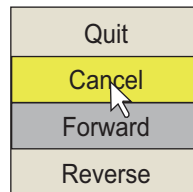

6. Select [Forward] or [Reverse] as required.
  - [Normal]: Upward scrolling decreases value; downward scrolling increases value.
  - [Reverse]: Reverse results of [Forward].
7. Click [Quit] on the setting box to close the box.
8. Long-push the **MENU/ESC** key to close all menus.

## 6.3 Display Setting Menu

The [Display Setting] menu sets various display-related items according to operator's preference. To display the menu, open the main menu then click [Others] and [Display Setting] in succession.

Display Setting		Quit
Mode Selection	: Mode Key	
Echo Display Area	: Within Range	
H2 Display	: Landscape	
2nd Monitor Setting	: Portrait	
V-Scan Aspect Ratio	: Fixed	
V-Scan Dpt Rng	: 100	
Presentation Mode	: Head Up	
TM Disp Range	: 1.6R	
Full Screen Area	: 1.6R	
Tilt lever	: Tilt	
<b>F10</b> Gain Knob Setting	: Execute	
Gain Control Step	: 0.5	
Auto Tilt	: Narrow	
<b>F9</b> Net Course Mark	: Execute	
Dimmer	: 7	
Key Beep Volume	: 5	
Timer Display	: OFF	
Circle Cursor Diameter	: 200m	

**[Mode Selection]:** Determines how display modes are chosen: **MODE** key or pull-down menu.

**[Echo Disp Area]:** Selects the echo display mode for the horizontal display, [Within Range] or [Full Screen]. See page 1-10.

**[H2 Display]:** Selects the combination mode of two horizontal displays: [Landscape], [Portrait], or [Inset].

**[2nd Monitor Setting]:** Select the combination mode for the sub-display; Landscape or Portrait.

**[V-Scan Aspect Ratio]:** Selects the type of the horizontal to vertical ratio to use on the V-display; [Fixed] or [Flexible].

**[V-Scan Dpt Rng]:** Sets the ratio (%) to reduce the display range of the depth direction in the vertical display. The setting range is 20-100. Adjustment is disabled (grayed out in menu) when [V-Scan Aspect Ratio] is set to [Fixed].

**[Presentation Mode]:** Selects the presentation mode. Head-up, North-up, Course-up and true motion (requires ship's speed and heading data) are available.

**[TM Disp Range]:** Selects how many times to expand the display range in the true motion mode. 1.3R (R=Range) and 1.6R are available.

**Note:** When you set [TM Disp Range] to 1.3R and [Full Screen Area] to 1.6R, the full screen area for the TM mode becomes 1.6R.

**[Full Screen Area]:** Selects a configuration for the full screen display, 1.3R or 1.6R.

**[Tilt lever]:** Selects function of the **TILT** control. [Tilt] sets the tilt only. [Tilt & V1] sets the bearing of the vertical 1 display in the vertical display and sets the tilt in the horizontal display.

**[Gain Knob Setting]:** Adjusts the functions of the **GAIN** control. Select this setting or left click the gain indication on the screen to display the window shown below. To change the value of an item, push the function key **F10** to select (highlight) the item, then operate the **GAIN** control or spin the scrollwheel to change the value. (The cursor must be selecting the item to change to use the scrollwheel.) The default arrangement assigns the **GAIN** knob function selection to function key **F10**.

G	10.0	<b>[G]:</b> Adjust sensitivity of the entire picture.
N.G	5.0	<b>[N.G]:</b> Gain is adjusted within the distance specified with [Near Gain Range].
F.G	5.0	<b>[F.G]:</b> Gain is adjusted within the distance specified with [Far Gain Range].
NS	0.0	<b>[NS]:</b> Suppress weak noise.
AGC	0.0	<b>[AGC]:</b> Suppress weak echoes.

**[Gain Control Step]:** Sets the interval of change with adjustment of the **GAIN** knob.

[0.1]: Gain is adjusted in increments of 0.1.

[0.2]: Gain is adjusted in increments of 0.2.

[0.5]: Gain is adjusted in increments of 0.5.

**[Auto Tilt]:** Selects the auto tilt angle, [Wide] ( $\pm 2^\circ$  to  $10^\circ$ ,  $\pm 4^\circ$  to  $16^\circ$ ,  $\pm 6^\circ$  to  $20^\circ$ ) or [Narrow] ( $\pm 1^\circ$  to  $4^\circ$ ,  $\pm 2^\circ$  to  $6^\circ$ ,  $\pm 3^\circ$  to  $8^\circ$ ).

**[Net Course Mark]:** Inscribes/deletes the net course mark. For details, see section 2.20.

**[Dimmer]:** Adjusts the backlighting (setting: 0 - 7) for the keys on the control unit.

**[Key Beep Volume]:** Sets the volume of the beep which sounds for key operation. The setting range is 0 to 7. "0" turns off the key beep.

**[Timer Display]:** Set [ON] to show the timer window at the bottom left of the display. The timer window can be moved by drag and drop operation. Operate the timer window as shown below.

1. Select [▶] on the timer window and push the left button to start the timer.  
The icon [▶] on the timer window changes to [●].
2. Select [●] on the timer window and push the left button to stop the timer.  
The icon [●] on the timer window changes to [▶].
3. Select [◀] on the timer window and push the left button to reset the timer.

#### Timer operation by function key

Timer start and stop can be controlled with a function key. For how to program a function key see paragraph 5.2.2.



To control timer start and stop from the timer window, do as follows:

1. With the timer stopped, press the function key assigned to timer operation.  
Time measurement starts, and the label on the [▶] button changes to [●].
2. Press the same function key pressed at step 1.  
Time measurement stops, and the label on the [●] button changes to [▶].
3. To restart measurement from the beginning, press the function key operated at step 1 twice within one second.  
The time display shows "00:00".

**[Circle Cursor Diameter]:** Sets the default diameter of the circle cursor. See section 2.16.2.

## 6.4 Alarm & Audio Menu

The [Alarm & Audio] menu sets the fish alarm and the audio bearing mark sector. To show this menu, open the main menu, then click [Others] and [Alarm & Audio] in succession.

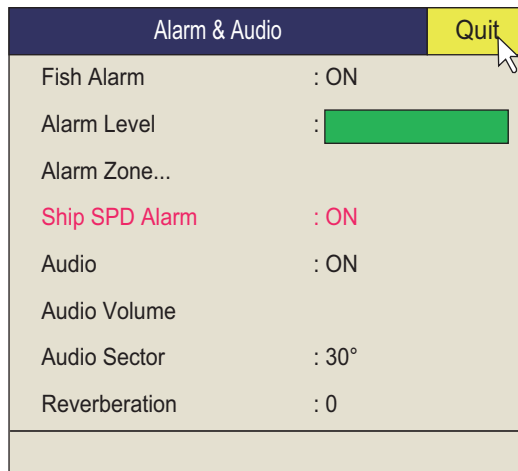

**[Fish Alarm]:** Turns the fish alarm function on or off. The default setting is [OFF].

**[Alarm Level]:** Sets the minimum echo color which triggers the fish alarm.

**[Alarm Zone]:** Sets fish alarm zone. For details, see section 2.14.

**[Ship SPD Alarm]:** The default setting is ON. The alarm is released if ship's speed exceeds the following speeds:

Transducer state	Projected length (mm)	Max. speed (kn)
Stopped	Less than 1100	20.0
	1100 to 1300	18.0
	Over 1300	16.0
Raising or lowering	Less than 1100	14.5
	1100 to 1300	13.5
	Over 1300	12.0

**[Audio]:** Turns the audio function on/off.

**[Audio Volume]:** Adjusts the volume of the audio alarm.

**[Audio Sector]:** Selects the audio sector width for use with audio function.

**[Reverberation]:** Selects the length of reverberation for audio signal. The setting range is 0 to 9. 0 is no reverberation. The larger the setting, the longer the reverberation.

## 6.5 Register Menu

The [Register] menu provides various programming functions. To show this menu, click [Register] on the [Others] menu.

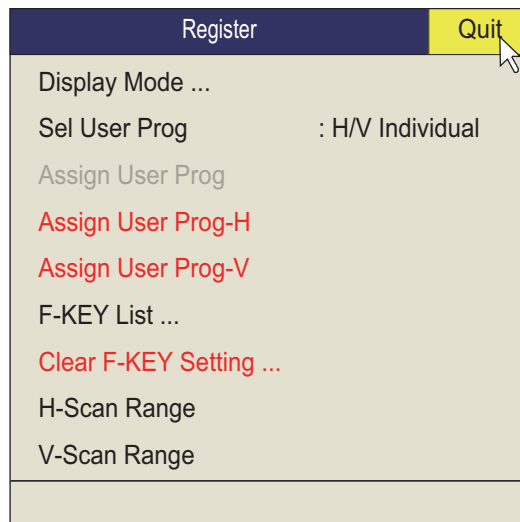

[Sel User Prog] = [H/V Interlock]

**[Sel User Prog]/[Assign User Prog]/USER PROG** control programming. See section 5.3.

**[Display Mode]:** Selects the display mode to use.

**[F-KEY List]:** Shows the functions assigned to each function key.

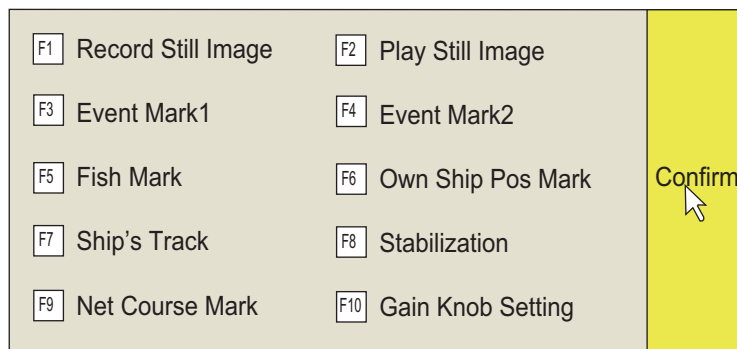

**[Clear F-KEY Setting]:** Erases program assigned to a function key.

**[H-Scan Range]:** Presets the horizontal mode ranges as selected with the **RANGE** control. The setting range is 60 to 5000 m.

**[V-Scan Range]:** Presets the vertical scan ranges as selected with the **RANGE** control. The setting range is the same as that for [H-Scan Range].

## 6.6 Initial Setting Menu

The [Initial Setting] menu sets up language, remote controller, and 12 sub menus, which contain settings for various marks.

**Note:** Operation on the [Initial Setting] menu is stopped whenever the transducer control keys are operated. Re-set this menu after concluding transducer operations.

1. Press the **MENU/ESC** key to show the main menu.
2. Select [Others] then push the left button.
3. Select [Initial Setting] then push the left button.
4. Select [Changeable] then push the left button.

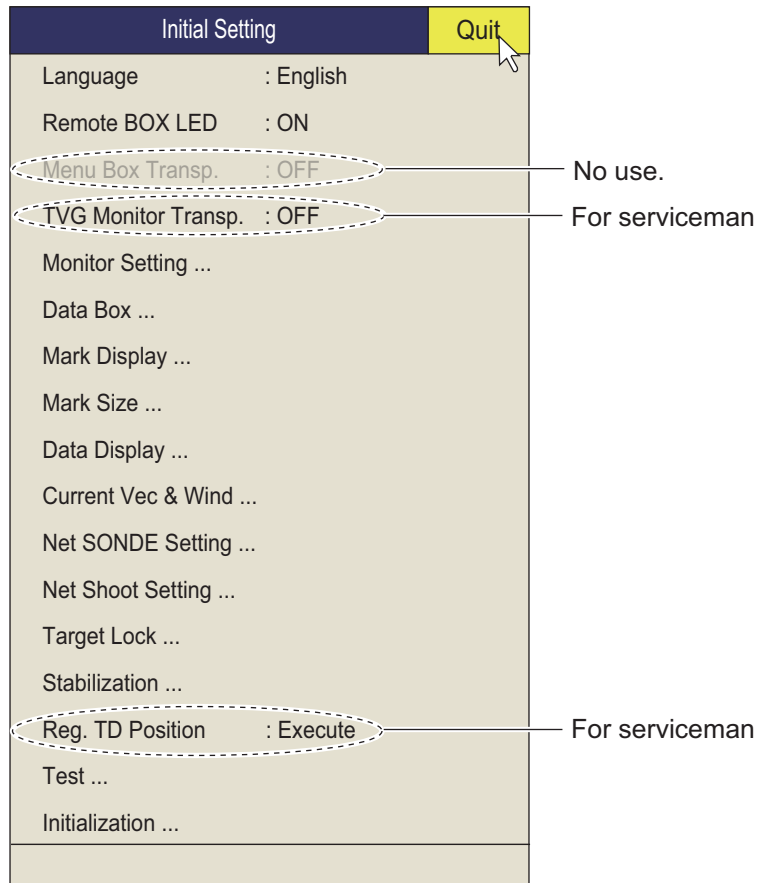

For [Target Lock] and [Test], see page 2-18 and page 8-11, respectively.

**Note:** Alpha blending technology is used for transparency effects.

**[Remote BOX LED]:** Turns ON/OFF the LED of the remote controller (option).

**Monitor Setting menu**

The [Monitor Setting] menu sets the function of dual monitors. Click [Monitor Setting] on the [Initial Setting] menu to show the [Monitor Setting] menu.

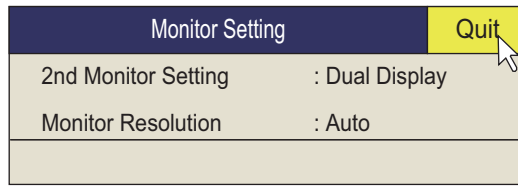

**[2nd Monitor Setting]:** Selects the display format for the sub monitor ([OFF], [Dual Display], [Sub Display]).

**Note:** When the above setting is changed the default display arrangement is restored.

- [OFF]: Select if a single monitor is connected.
- [Dual Display]: Main and sub monitors show different pictures in the combination display mode.
- [Sub Display]: Main and sub monitors show the same picture in the combination display mode.

Display mode	Dual display		Sub display	
	Main monitor	Sub monitor	Main monitor	Sub monitor
H2	H1	H2	H1/H2	H1/H2
V1	H1	V2	H/V1	H/V1
V2	H	V1/V2	H/V1/V2	H/V1/V2

**[Monitor Resolution]:** Selects the monitor resolution, among [Auto], [SXGA], [UXGA], [WUXGA]. Reset the power to apply setting. The vertical size and display position are changed. If necessary adjust the display.

**Data Box menu**

The [Data Box] menu sets the readout format for the marks on the display. Click [Data Box] on the [Initial Setting] menu to show the [Box] menu. This menu is also shown on the pop-up menu.

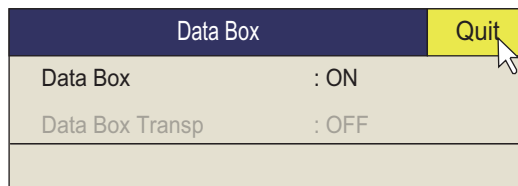

**[Data Box]:** Turns the numeric/graphic data display on/off.

**Mark Display menu**

The [Mark Display] menu turns on/off marks. Click [Mark Display] on the [Initial Setting] menu to show the [Mark Display] menu.

Mark Display		Quit
Heading Mark	: ON	
Range Rings	: ON	
Bearing Scale	: ON	
Own Ship's Track Plot	: ON	
Data on Track	: ON	
Net Move Plot	: ON	
Fish Mark Connect	: ON	
Target Vector	: ON	
Fish Track Plot	: On	
EVENT Key	: Event	
Histogram Disp	: ON	
Mark Color	: White	
TD Position Mark	: ON	

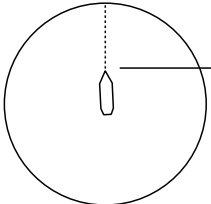
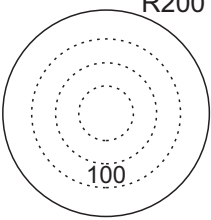
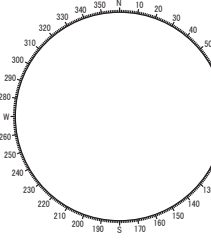
Mark, description	Mark appearance
<p><b>[Heading Mark]:</b> The heading mark is a dashed line which indicates the heading in all presentation modes. It extends from own ship position to the outer edge of the display and appears at zero degrees in the head-up mode. It changes the orientation depending on ship's orientation in the north-up, course-up and true motion modes.</p>	 <p>Heading mark</p>
<p><b>[Range Rings]:</b> The range rings are the dotted line circles about own ship, and they provide an estimate of the range to a target. Rings appear every distance of 1/2 or 1/4 of the range depending on menu setting. The number of range rings to display can be set with [Range Ring Interval]. See [Range Ring Interval] on page 6-11.</p>	
<p><b>[Bearing Scale]:</b> The bearing scale is the concentric solid circle at the edge of the display. It provides an estimate of the bearing to a target. The scale can be turned on or off and its degree of division selected.</p> <p>[Coarse]: Puts a division mark every 10° and has no numeric indication.</p> <p>[Fine]: Puts a division mark every 1° and has numeric indication every 10°.</p>	
<p><b>[Own Ship's Track Plot]:</b> Traces ship's movement with a solid line. When the track memory becomes full, the earliest track is automatically erased to trace new track. Requires speed and course data.</p>	

6. OTHERS MENU

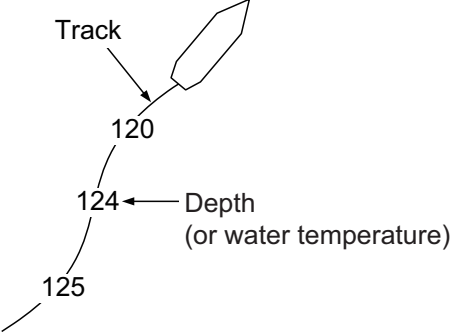
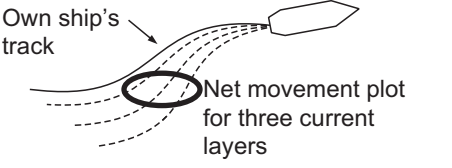
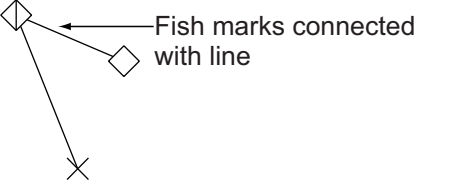
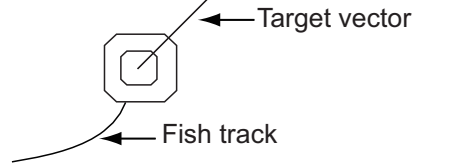
Mark, description	Mark appearance
<p><b>[Data On Track]:</b> Shows depth or water temperature on the ship's track.</p>	 <p>Track</p> <p>120</p> <p>124 ← Depth (or water temperature)</p> <p>125</p>
<p><b>[Net Move Plot]:</b> Shows predicted net movement against three current layers over time. Automatically turned on or off with the net shoot mark. Requires the current data.</p>	 <p>Own ship's track</p> <p>Net movement plot for three current layers</p>
<p><b>[Fish Mark Connect]:</b> You may connect fish marks with a line to show the order in which they were entered.</p>	 <p>Fish marks connected with line</p>
<p><b>[Target Vector]:</b> This is a line extending from the target lock mark, and it shows speed and direction of tracked school of fish. See the illustration below for appearance.</p>	 <p>Target vector</p> <p>Fish track</p>
<p><b>[Fish Track Plot]:</b> Traces target movement in target lock. Requires speed and course data.</p>	
<p><b>[EVENT Key]:</b> Selects the key to enter the own ship's position mark (Event key, Shoot key).</p>	
<p><b>[Histogram Disp.]:</b> Shows signal strength distribution for the school(s) of fish marked with an estimate mark on the horizontal display.</p>	
<p><b>[Mark Color]:</b> Selects the color of the event, fish school, and fish estimate marks. (Settings: White, Light -blue, Blue, Yellow, Purple, Green) The mark color can not be set individually.</p>	
<p><b>[TD Position Mark]:</b> Indicates transducer position. See section 1.4.3.</p>	

**Mark Size menu**

The [Mark Size] menu lets you select the size and shape of the marks. Click [Mark Size] on the [Initial Setting] menu to show the [Mark Size] menu.

Mark Size		Quit
Trackball Mark	: + Small	
Target Lock Mark	: Normal	
Target Vector	: Small	
Event Mark	: Large	
Fish Mark	: Large	
Own Ship Pos Mark	: Normal	
Own Ship Mark	: Actual	
Net Shoot Mark	: Normal	
Estimate On Scan	: Large	
Current Vector	: Small	
Range Ring Interval	: 1/4R	
Bearing Scale	: Small	
Own Ship's Track Plot	: 5R	

**[Trackball Mark]:** Selects size and appearance of cursor. The choices are large “+” mark, small “+” mark.

**[Target Lock Mark]:** The target lock mark size is available in normal, large, or small.

**[Target Vector]:** You may display the target vector in short, normal or long lengths. Set “long” for slow moving target; “short” for faster moving target.

**[Event Mark]:** Selects event mark size; normal, large, or small.

**[Fish Mark]:** Displays the fish mark in normal, large, or small size.

**[Own Ship Pos Mark]:** Shows the own ship position mark in normal, large, or small size.

**[Own Ship Mark]:** Selects size of own ship mark to standard, large, or actual.

**[Net Shoot Mark]:** You may show the net shoot mark in normal, large, or small size.

**[Estimate On Scan]:** Selects the size of the fish estimate mark on the horizontal display for small or large.

**[Current Vector]:** The length of the current vector may be set to short, long, short/thick, or long/thick.

**[Range Ring Interval]:** Selects the range ring interval.

[1/4R]: Ring interval is 1/4 of the detection range.

[1/2R]: Ring interval is 1/2 of the detection range.

[Auto]: Ring interval and number of rings (3 to 5) are automatically set according to the detection range. For example, if the detection range is 500 m, five rings are displayed, at 100 m intervals.

**[Bearing Scale]:** Selects the size of the bearing scale for small or large size.

## 6. OTHERS MENU

**[Own Ship's Track Plot]:** Selects the amount of track to display; 5R, 10R, 20R, 40R (R=Range).

### **Data Display menu**

This menu turns on/off alphanumeric data. Click [Data Display] on the [Initial Setting] menu to show the [Data Display] menu.

Data Display		Quit
Range&Bearing	: ON	
Fishing Area	: OFF	
Cursor Position	: OFF	
Course	: 32 CMPS	
Current Data	: 360°True	
Event Mark	: 32 CMPS	
Other Marks	: ±180°	
Distance For Shoot	: NM	
Water Temp	: °C	
Water Temp Range	: 20 Minute	

**[Range/Bearing]:** Turns on/off the range and bearing data which appears when the range/bearing marks are turned on.

**[Fishing Area]:** Not used.

**[Cursor Position]:** Turns on/off the cursor position (latitude and longitude) display. (Requires navigation data.)

**Note:** When [EXT Data] on [Setting]-[Lat/Lon] on system menu is set to [Disable], the cursor position is not displayed even if the [Cursor Position] on [Initial Setting]-[Data Display] is set to [ON]. For the System menu, contact your dealer.

**[Course]:** Selects how to display course; [32 CMPS] (32 compass points), [360°True] (true bearing), [360°] (360° Relative), [±180°] (180° Relative). [±180°] shows xxxS in case of starboard direction; xxxP in case of port direction (xxx: 1 to 180). Heading sensor is required to set to [360°True]. [32 CMPS] shows bearing with alphabet indication, for example, "N", "N/E", "NNE", "NE/N", etc.

**[Current Data]:** Selects how to display tidal current data; [32 CMPS] (32 compass points), [360°True] (true bearing), [360°] (360° Relative), [±180°] (180° Relative).

**[Event Mark]:** Selects how to display event mark data; [32 CMPS] (32 compass points), [360°True] (true bearing), [360°] (360° Relative), [±180°] (180° Relative).

**[Other Marks]:** Selects how to display other mark data; [32 CMPS] (32 compass points), [360°True] (true bearing), [360°] (360° Relative), [±180°] (180° Relative).

**[Distance For Shoot]:** Selects the distance run unit to show the distance run after shooting the net. The options are miles, meters and feet.

**[Water Temp]:** Selects water temperature unit; in °C (Celsius) or °F (Fahrenheit).

**[Water Temp Range]:** Selects the time range to show water temperature, 20 Minute, 1 Hour, 6 Hours, 12 Hours or 24 Hours.



### Current Vec & Wind menu

The [Current Vec & Wind] menu sets up tidal current and wind data. Click [Current Vec & Wind] on [Initial Setting] menu to show the [Current Vec & Wind] menu.

Current Vec & Wind		Quit
Current Data	:	Water Current
On Own Ship Mark	:	ON
On Ship Pos Mark	:	ON
On Net Shoot Mark	:	ON
Current Flow Dir	:	To
Wind	:	OFF
Select Water Current ...		

**[Current Data]:** Selects how to display current data; absolute or in relation to layer 1 to layer 5.

**[On Own Ship Mark]:** Shows or hides the current mark on the own ship mark.

**[On Ship Pos Mark]:** Shows or hides the current mark on the own ship position mark.

**[On Net Shoot Mark]:** Shows or hides the current mark on the net shoot mark.

**[Current Flow Dir]:** Selects how to display current data. [FROM] shows from what direction the current is flowing; [TO] shows the direction the current is heading. Requires connection of a current indicator.

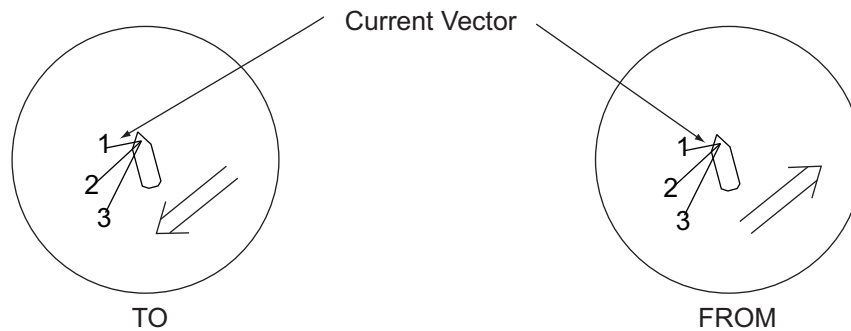

**[Wind]:** Selects wind display; OFF, relative wind data or true wind data.

**[Select Water Current]:** Selects the water current layer(s) to use. Layer 1 to Layer 5. You can select a maximum of three. The selected layers are marked with a check-mark.

**Net SONDE Setting menu**

The [Net SONDE Setting] menu sets up the net sonde. Click [Net SONDE Setting] on the [Initial Setting] menu to show the [Net SONDE Setting] menu.

Net SONDE Setting		Quit
Number of XMTR*	: 3	
XMTR Distance ...		
Net Length	: 1800m	
Depth Display ...		
Display Style	: Numeric	
Depth Graph Range	: 100m	

\*Setting cannot be adjusted after the net is thrown.

**[Number Of XMTR]:** Sets number of transmitter units used, from 0 to 10. When the total value of [XMTR Distance] is smaller than the setting value of [Net Length], max. 10 transmitter units can be used.

**[XMTR Distance]:** Sets the distance between transmitters. Select this item then push the left button to set the distances.

XMTR Distance		Quit
End of Net to S1	: 400m	
S1->S2	: 400m	
S2->S3	: 400m	
S3->S4	: 400m	

**[Net Length]:** Sets net length in increments of 100 m. The minimum value changes according to [Number of XMTR] and [XMTR Distance].

**[Depth Display]:** Selects which sonde depth data to show, a shown in the right figure. Select this item and push the left button to select net sondes. The check mark shows current selection (Max. 3).

**[Display Style]:** Selects the display format of the net depth, Numeric or Graph.

**[Depth Graph Range]:** Sets the depth range of the SONDE graph. The settings 50 m, 100 m, 150 m, 200 m.

	Quit
	Cancel
✓	S1
✓	S2
✓	S3
	S4
	S5
	S6
	S7
	S8
	S9
	S10

### Net Shoot Setting menu

The [Net Shoot Setting] menu sets up net shoot parameters. Click [Net Shooting Setting] on the [Initial Setting] menu to show the [Net Shoot Setting] menu.

Net Shoot Setting		Quit
Net Diameter	: 500m	
Tilt Interlock	: ON	
Net Plot Corr-LYR1	: 50%	
Net Plot Corr-LYR2	: 50%	
Net Plot Corr-LYR3	: 50%	
Net Plot Corr-LYR4	: 50%	
Net Plot Corr-LYR5	: 50%	

**[Net Diameter]:** Sets net diameter in increments of 10 meters. The setting range is 200 m to 1000 m.

**[Tilt Interlock]:** Turns on/off interlocking of diameter of net course mark with tilt angle.

**[Net Plot Corr-LYR1] - [Net Plot Corr-LYR5]:** The movement of the net during net shooting is plotted using water current speed and direction fed from a current indicator. The current indicator feeds that data for three depths (layers), thus net movement will be different at each layer. Determine degree of difference among layers considering net, sea conditions, etc. If 50% is set, for example, the net movement plot mark moves at speed of 50% of water current speed.

### Stabilization menu

The [Stabilization] menu compensates for the affects of pitching and rolling. Click [Stabilization] on Initial [Setting menu] to show the [Stabilization] menu. Requires a inertial measurement unit.

Stabilization		Quit
F8 Stabilization	: ON	
Pitch Angle Cor	: 0.0	
Roll Angle Corr	: 0.0	
Sensor	: Standard	

**[Stabilization]:** Turns stabilization on/off.

**Note:** The default function of the **F9** key turns stabilization on/off.

**[Pitch Angle Cor]:** Offsets the pitch angle error generated by the inertial measurement unit.

**[Roll Angle Cor]:** Offsets the roll angle error generated by the inertial measurement unit.

**Initialization menu**

Click [Initialization] on the [Initial Setting] menu to show the [Initialization] menu.

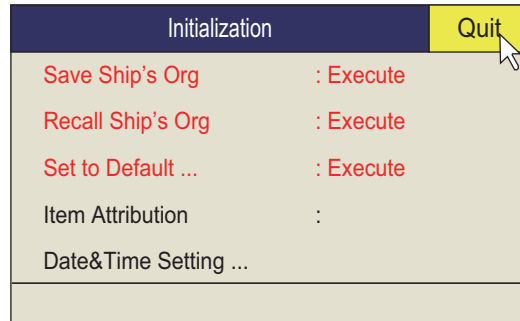

**[Save Ship's Org]:** All menu settings are saved.

**[Recall Ship's Org]:** Recalls the saved menu settings. Default settings are memorized in the internal memory. Use this item to recall the setting then rotate the **USER PROG** control.

**[Set To Default]:** Restores all default menu settings.

**Note 1:** The settings for [Save Ship's Org] are not affected when default settings are restored.

**Note 2:** The transducer position setting is also set to default and the message "UNREGISTERED" appears. See the Installation Manual for how to enter transducer position.

**[Item Attribution]:** Locks/unlocks protected menu settings. Asterisk-marked items on this page and [Ship Speed] in the [Alarm & Audio] menu cannot be adjusted by the user.

**[Date & Time Setting]:** Sets date, time, and time zone.

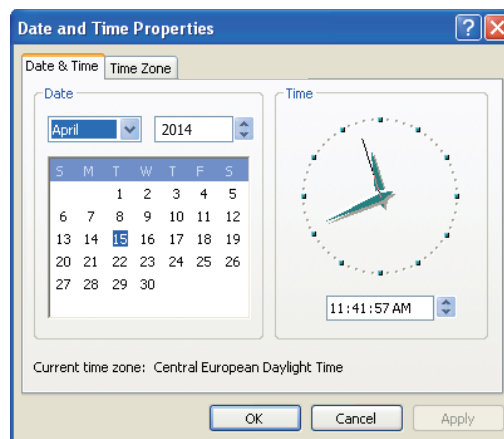

# 7. RECORD/RECALL OPERATION

You can take still images of the display and store them internally.

## 7.1 How to Specify Where to Save Still Images

You can specify where to save still images as follows:

1. Right click the numeric/graphic data display to show the pop-up menu.
2. Click [Record/Recall].

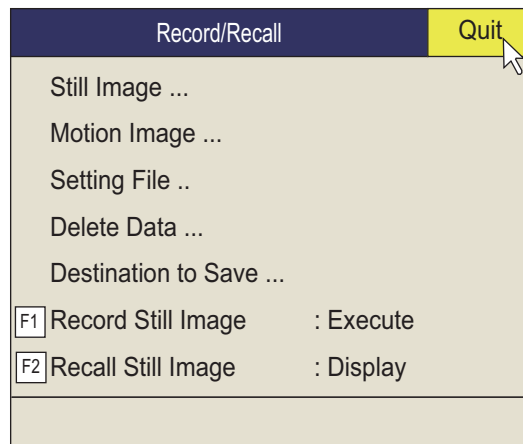

3. Click [Destination To Save].

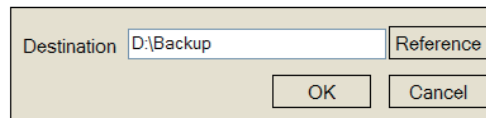

4. Click [Reference] on the [Destination To Save] window.

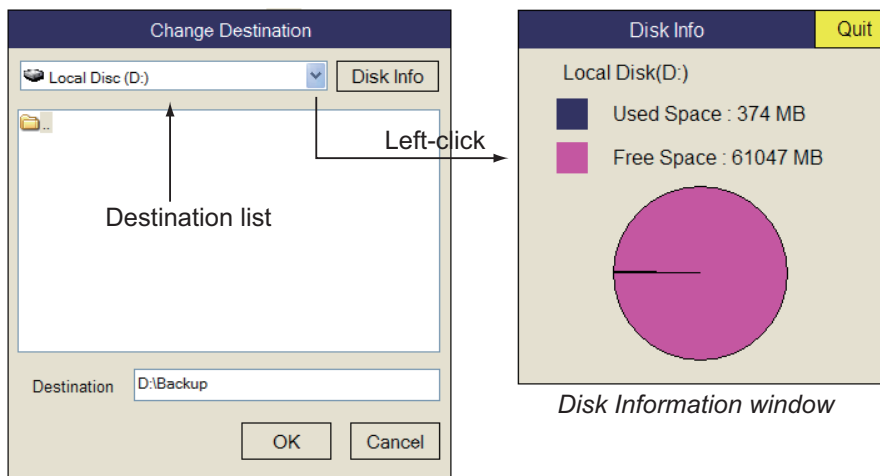

**Note:** The capacity of the D drive may be changed.

5. Specify the location where to save the still image from the pull-down menu. "D" drive saves a still image to a folder whose name is automatically given the current data (yyyy.mm.dd).
6. Click the [OK] button.
7. Long-push the **MENU/ESC** key to close all menus.

## 7.2 How to Save Still Images

You can save the picture on the display as a still image. Also, you can enter the comment for the image.

The still image data is saved at the location selected at section 7.1 with the setting data. Date and time are used for the name of the data automatically.

- Still image: “yyyy\_mm\_dd\_hh\_mm\_ss\_comment.jpg”
- Setting: “RECORD\_yyyy\_mm\_dd\_hh\_mm\_ss\_comment.dat”

### **Saving with the [Still Image] window**

1. Right click the numeric/graphic data display to show the pop-up menu.
2. Click [Record/Recall].
3. Click [Still Image].

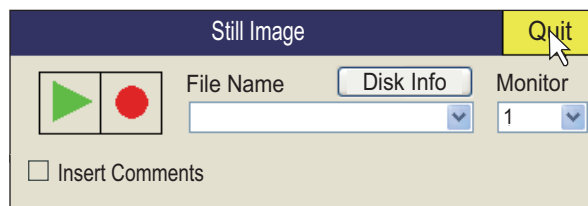

4. To enter a comment, check the box for [Insert Comments].
5. Click the [•] button on the [Still Image] window to save the still image. The picture at the moment the button is pushed is shown on the display (preview\*). If you checked the box for [Insert Comments], the software keyboard appears.
 

\*: If you did not check the box for [Insert Comments], the preview disappears after four seconds.



↑ Click [Shift] to switch windows.

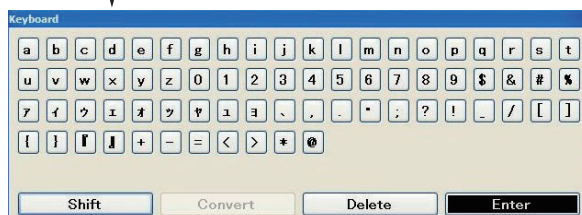

[Shift]: Switches layout and type of characters and symbols.

[Convert]: For future use.

[Delete]: Deletes a previous character.

[Enter]: Confirms data entry and closes the window.

6. Click the character or symbol to enter the comment (max. 20 characters or symbols).
7. Click [Enter] to close the software keyboard and the still image preview.
8. Click [Quit] on the [Still Image] window to close the window.

**Note 1:** If you check the box for [Insert Comments], you can enter a comment when you use [Record Still Image]. See the next topic.

**Note 2:** You can enter a comment only when saving the still image. You can not edit the comment when recalling a still image.

**Saving with the [Record Still Image] menu**

1. Right click the numeric/graphic data display to show the pop-up menu.
2. Click [Record/Recall].
3. Click [Record Still Image].  
The picture at the moment the button is pushed is shown on the display (preview).  
If you checked the box for [Insert Comments], the software keyboard appears.
4. Click the character or symbol to enter the comment (max. 20 characters or symbols).
5. Click [Enter] to close the software keyboard and the still image preview.

**Note 1:** The default function of the **F1** key saves the still image.

**Note 2:** You can select how long to show the preview display. Contact your dealer for details.

**Dual display**

Select the monitor on which to capture the still image, 1: main monitor, 2: sub monitor.

1. Right click the numeric/graphic data display to show the pop-up menu.
2. Click [Record/Recall].
3. Click [Still Image].

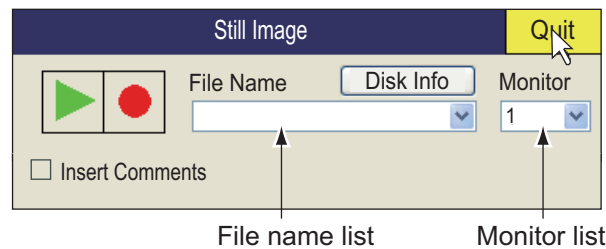

4. Select the monitor on which to capture the still image from the monitor list.  
1: main monitor, 2: sub monitor.
5. Click the [•] button on the [Still Image] window to save the still image.
6. Click [Quit] on the [Still Image] window to close the window.

## 7.3 How to Display Saved Still Images

There are two ways to display saved still images.

- Display the latest still image
- Display a still image from the file name list

### 7.3.1 How to display the latest still image

1. Right click the numeric/graphic data display to show the pop-up menu.
2. Click [Record/Recall].
3. Click [Play Still Image].  
The latest still image is shown on the display.

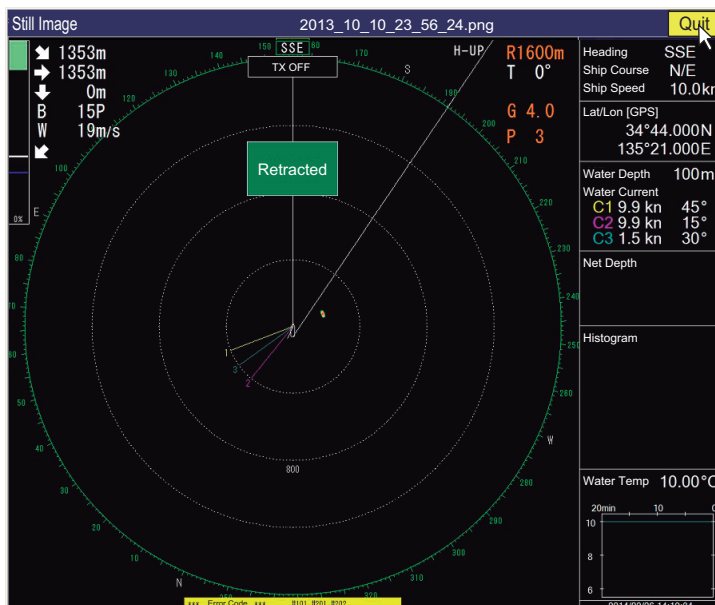

**Note:** The window can be resized, and moved by drag and drop. Also, you can zoom in/out with the scrollwheel.

4. Click [Quit] to close the window.

**Note:** The default function of the **F2** key displays the recalled still image window.



### 7.3.2 How to display a still image from the file list

1. Right click the numeric/graphic data display to show the pop-up menu.
2. Click [Record/Recall].
3. Click [Still Image].

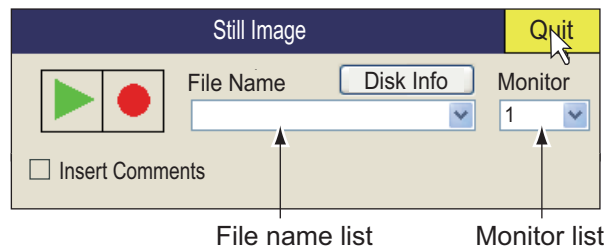

4. Select a file from the file list.
5. Select the play button (green triangle) on the window then push the left button to recall the still image window. A maximum of eight windows can be shown on the display.
6. Click [Quit] on the window to close the window.
7. Click [Quit] on the still image window to close the window.

## 7.4 How to Save Motion Images

The FSV-25/FSV-25S can store motion images as shown below.

1. Right click the numeric/graphic data display to show the pop-up menu.
2. Click [Record/Recall].
3. Click [Motion Image].

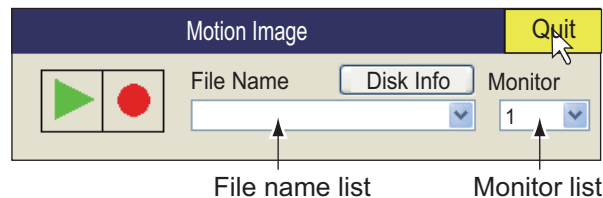

4. If two monitors are used, select where to save the image. 1, Main monitor, 2, Sub monitor.
5. Click the button with a red circle to start the saving.
6. Click the button with a red circle to stop the saving. The file is saved to the location specified in section 7.1. The file name is automatically saved in the following format:  
yyyy\_mm\_dd\_hh\_mm\_ss.avi  
**Note:** When the size of the image is greater than 2GB, the image is saved in divisions of 2GB. In this case the division no. appears after the "seconds" indication. For example, yyyy\_mm\_dd\_hh\_mm\_ss\_1.avi; yyyy\_mm\_dd\_hh\_mm\_ss\_2.avi.
7. Click [Quit] on the [Motion Image] menu to close the window.

**Note:** If the capacity at the destination is approaching maximum, the message "Disk capacity is approaching maximum. Delete unnecessary data." appears. In this case, select [Delete Data] then push the left button to delete unnecessary data.

## 7.5 How to Play Back Motion Images

You can play back motion images

1. Right click the numeric/graphic data display to show the pop-up menu.
2. Click [Record/Recall].
3. Click [Motion Image].

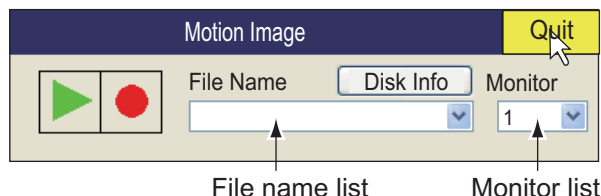

4. Select the file to play back from the file list.
5. Click the ► button to start the playback.

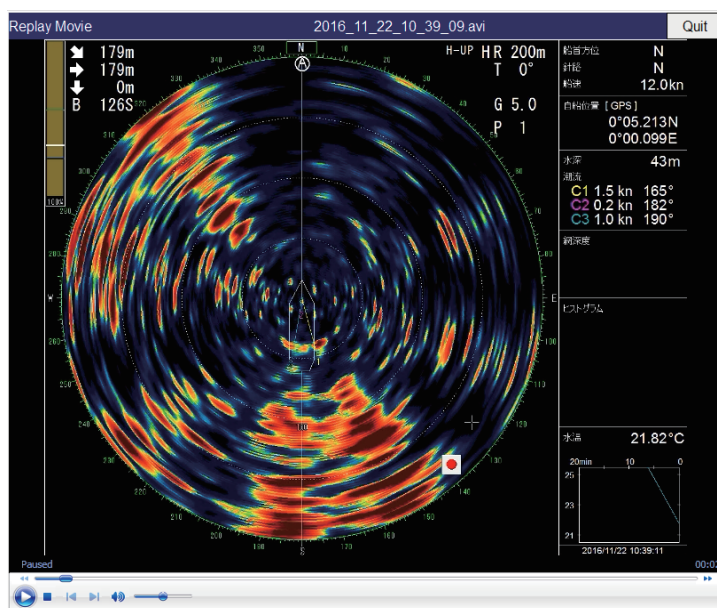

[Replay Movie] window

The [Replay Movie] window can be moved by drag & drop operation. Also, you can change the window size. Controls for stopping playback, fast forwarding and so on are provided on the [Replay Movie] or [Motion Image] window.

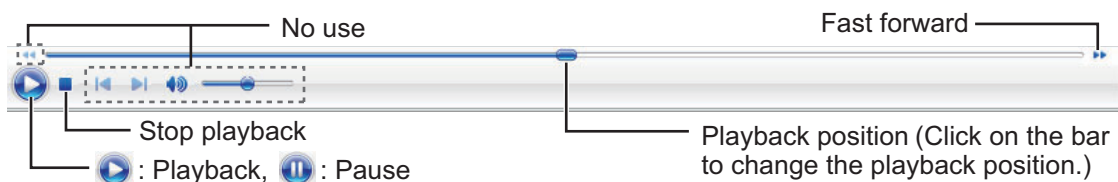

Operation bar at the bottom of the [Replay Movie] window\*

\*: Shown only for program version no. 105-0926-XX.XX

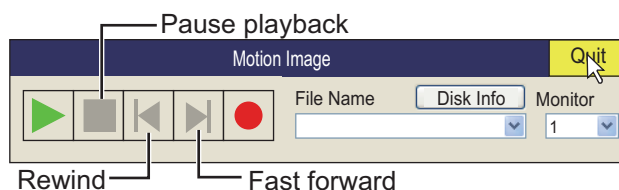

[Motion Image] window

6. Click [Quit] on the window to close the window.
7. Click [Quit] on the [Motion Image] window to close the window.

## 7.6 How to Save Setting Data

Current setting data can be saved, and saved setting data (P1 to P10) can be loaded into the equipment. This allows you to use setting data that data is useful for a specific task.

The setting data mentioned below is not saved if one or more of the settings for the **USER PROG** control is changed. See section 5.3.2 for how to program the **USER PROG** control.

1. Right click the numeric/graphic data display to show the pop-up menu.
2. Click the [Record/Recall].
3. Click [Setting File].

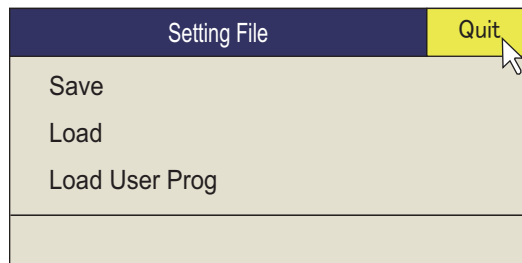

4. Click [Save]. The file name, which appears in the [File Name] box, is automatically assigned as shown below.  
FSV25\_yyyy\_mm\_dd\_hh\_mm\_ss.ini

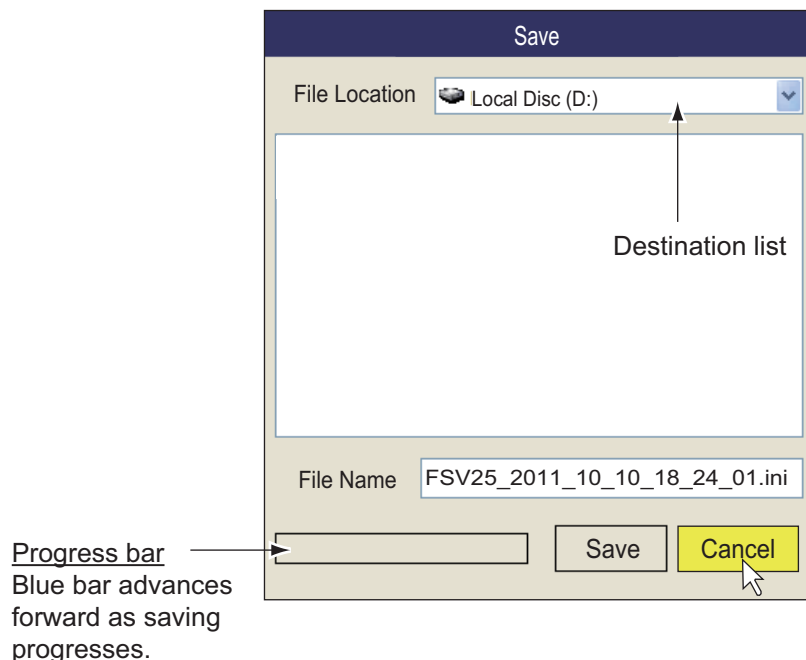

5. Select where to saved the save data, from the destination list.
6. Click the [Save] button. The progress bar advances as the saving progresses. After the saving is completed, the [Setting File] menu appears.
7. Long push the **MENU/ESC** key to close all menus.

## 7.7 How to Load Saved Data

### 7.7.1 How to load the setting information

This section shows you how to load the setting information saved at section 7.4.

1. Right click the numeric/graphic data display to show the pop-up menu.
2. Click [Record/Recall].
3. Click [Setting File].
4. Click [Load].

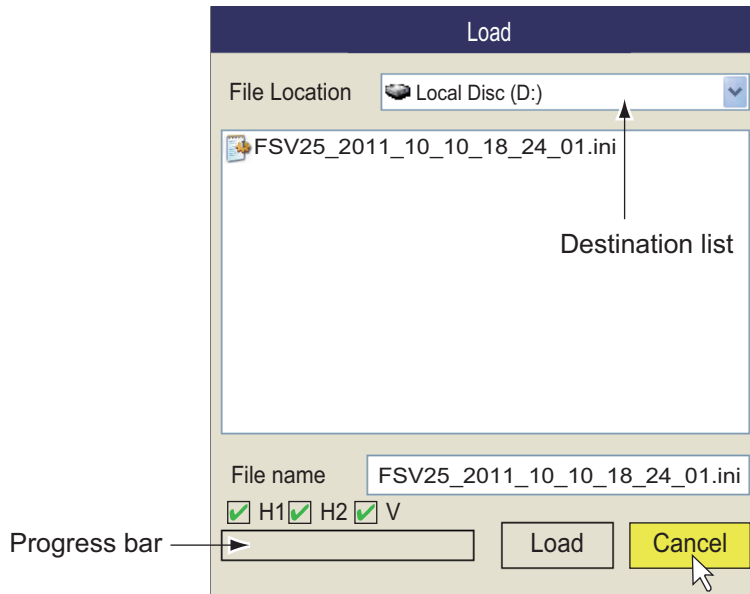

5. Select the file to load.
6. Check the scan mode ([H1], [V2], [V]) to which to load data.
7. Click the [Load] button.  
The progress bar shows the loading progress. The [Setting File] menu appears when the saving is completed.
8. Long press the **MENU/ESC** key to close all menus.

## 7.7.2 How to replay setting information

You may want to replay setting information to set up the equipment according to target fish or fishing ground.

1. Right click the numeric/graphic data display to show the pop-up menu.
2. Click [Record/Recall].
3. Click [Setting File].
4. Click [Load User Prog].

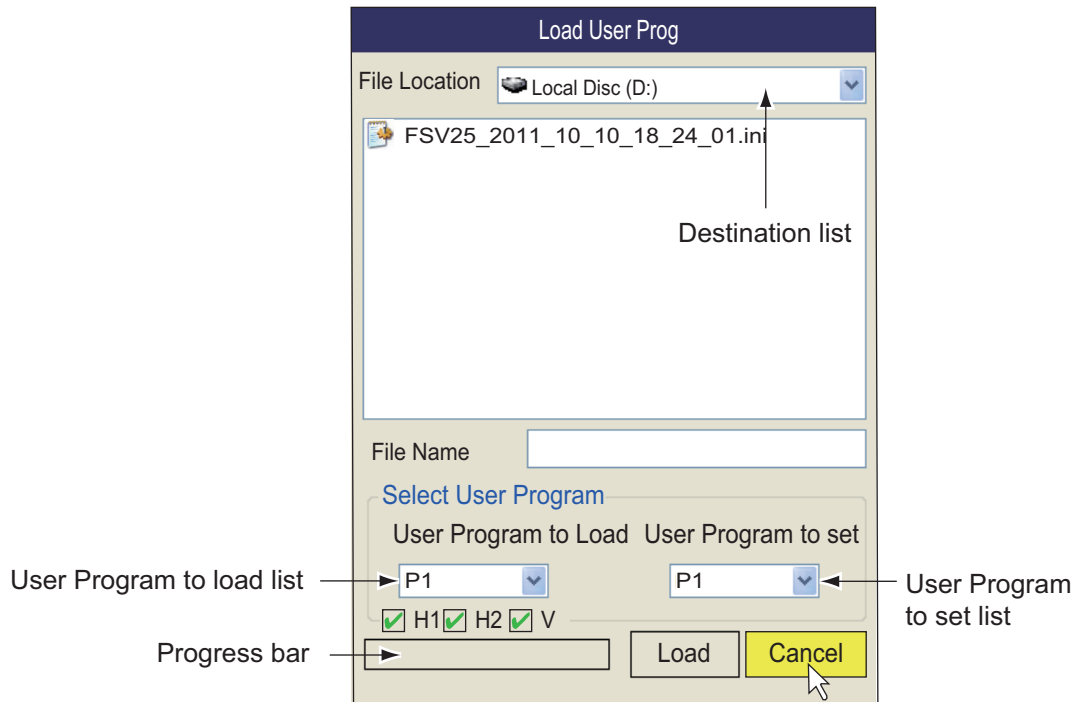

5. Select a file to load from the destination list.

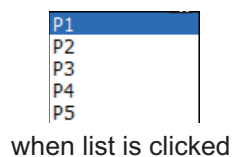

6. Click the setting number on the [User Program to load] list.
7. Click the setting number to load on the [User Program to set] list.
8. Check the scan mode ([H1], [V2], [V]) to which to load user program.
9. Click the [Load] button.  
The progress bar shows the loading progress. The [Setting File] menu appears when the saving is completed.
10. Long press the **MENU/ESC** key to close all menus.

## 7.8 How to Delete Files

You can delete unnecessary files as shown below.

1. Right click the numeric/graphic data display to show the pop-up menu.
2. Click [Record/Recall].
3. Click [Delete Data].

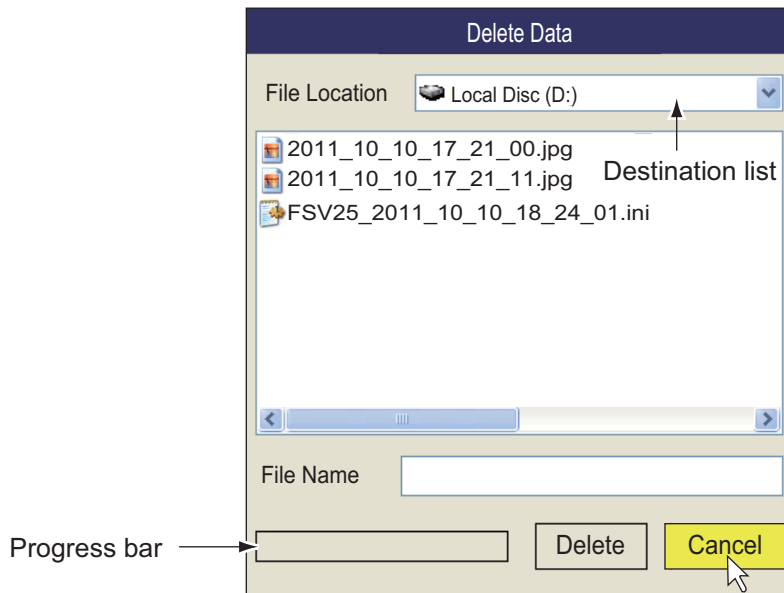



4. Select the file to delete.
5. Click the [Delete] button. The message "Are you sure to delete?" appears.
6. Click the [OK] button.  
The file selected at step 4 is deleted.
7. Click the [Cancel] button to return to the [Record & Recall] menu.
8. Long press the **MENU/ESC** key to close all menus.

# 8. MAINTENANCE, TROUBLE-SHOOTING

---

This chapter provides maintenance and troubleshooting procedures for the operator.

<p> <b>WARNING</b></p> <p> <b>ELECTRICAL SHOCK HAZARD</b> Do not open the equipment.</p> <p>This equipment uses high voltage that can cause electrical shock. Only qualified persons are allowed to work inside the equipment.</p>	<p><b>NOTICE</b></p> <p><b>Do not apply paint, anti-corrosive sealant or contact spray to plastic parts or equipment coating.</b></p> <p>Those items contain products that can damage plastic parts and equipment coating.</p>
--	--

## 8.1 Preventive Maintenance

Regular maintenance is important for keeping the equipment in good working order. Check the following points monthly.

- Check all cables. If damaged, replace.
- Check connectors at each unit. If loosened, reconnect.
- Check the ground terminal of each unit. Clean if necessary.

### Cleaning the cabinet of equipment

Remove the dust or dirt from the equipment with a soft, dry cloth. Do not use chemical cleaners to clean the equipment because they can remove paint and markings.

## 8.2 Hull Unit Maintenance

Care for the hull unit by following the procedures shown below.

\*1 Equivalent greases:

SHOWA SHELL OIL: Shell Albania

Grease S No.2

EXXON MOBIL: Mobilux EP No.2

NIPPON OIL CORPORATION: Multinox  
Grease No. 2

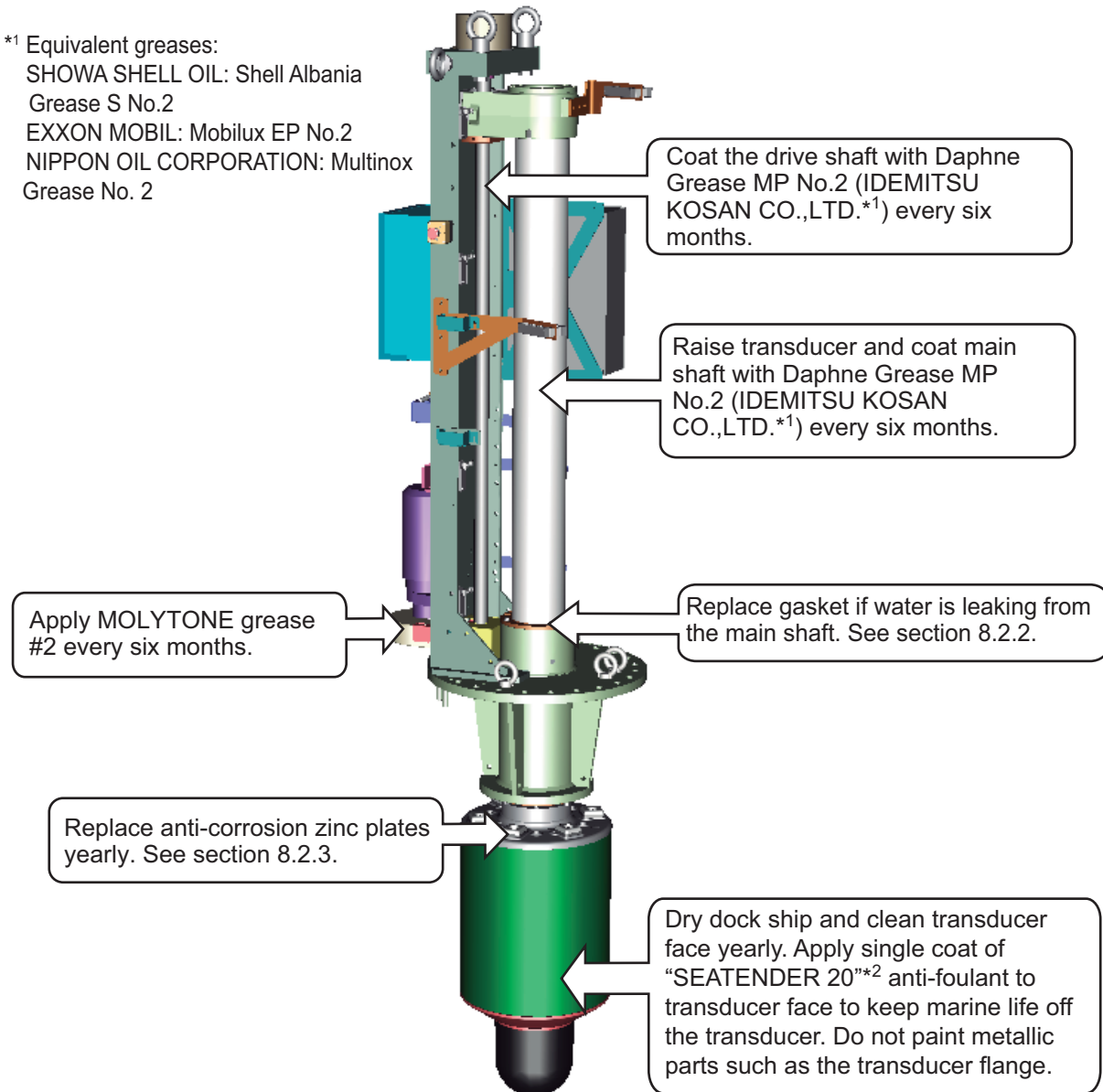

\*2 Equivalent coating (anti-foul):  
CHUGOKU MARINE PAINTS, Ltd.:  
SEA GRANDPRIX 660HS

**Note 1:** Do not mix SEATENDER 20 with SEA GRANDPRIX 660HS, or apply one over the other.

**Note 2:** It is possible to remove SEATENDER 20 and replace the coating with SEA GRANDPRIX 660HS. To remove the current coating, soak a nylon-based scrubbing pad in thinners, then apply the thinner to the coating in a washing motion. To prevent damage to the transducer, do not use tools (scrapers, etc) or sandpaper to remove the coating.



## 8.2.1 How to grease parts

### How to grease the gear box

1. Unfasten the wing nuts from the gear box to remove the gear cover window.

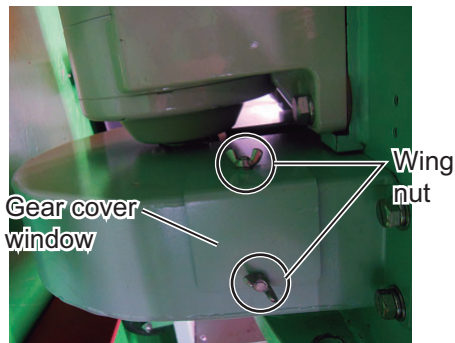

2. While raising and lowering the transducer manually with the ratchet wrench (see section 8.12.2), apply Molytone No.2 grease.

### How to grease the gear shaft

Inject Daphne Grease MP No.2 (IDEMITSU KOSAN CO.,LTD) to the grease nipple to grease the gear shaft.



Operation image

## 8.2.2 How to replace the gasket

If water is leaking from the main shaft, replace the gasket. A spare gasket is provided on the cover of the main shaft.

1. Unfasten four hex. head bolts to remove two seal support plates.
2. Cut and remove the gasket.
3. Take the spare gasket from the cover of the main shaft cover and set it to the main shaft.
4. Fasten the two seal support plates removed at step 1.

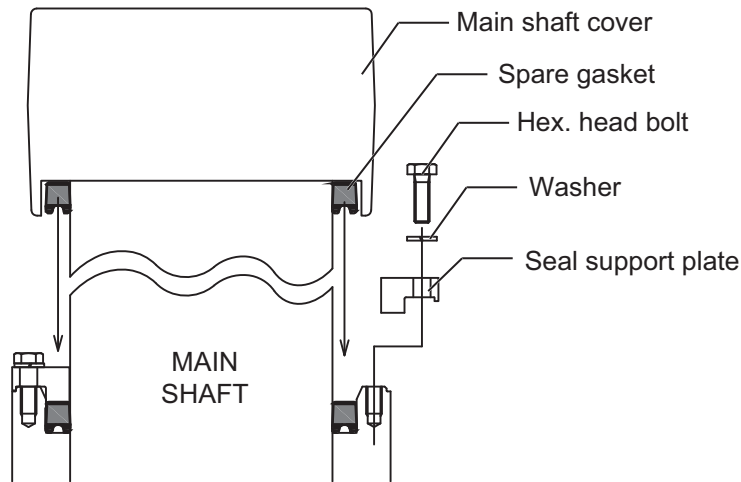

### 8.2.3 How to replace the anti-corrosion zinc plates

	CAUTION
<p><b>Replace the anti-corrosion zinc plates yearly.</b></p> <p>Corrosion may result, allowing water leakage and/or loss of transducer. The clearance between the hull and the ground or deck must be more than 900 mm.</p>	

1. Remove the silicone sealant covering the hex. head bolts.
2. Unfasten the hex. head bolts and then remove the washers (2 pcs.) and anti-corrosion zinc plates (6 pcs.).

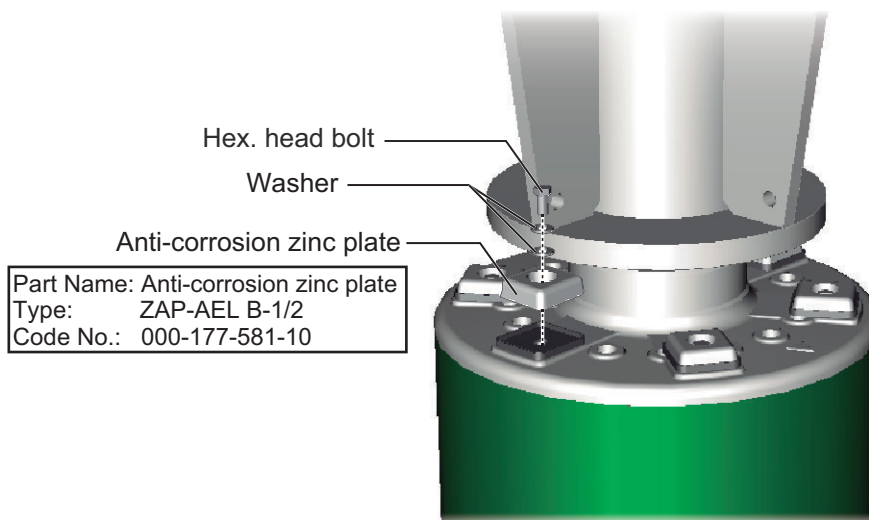

3. Set washers, new anti-corrosion zinc plates and hex. head bolts. Tighten the hex. head bolts.
4. Coat the holes for the hex. head bolts with silicone sealant.

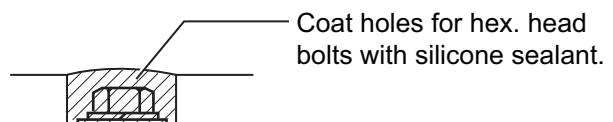

## 8.3 How to Replace Fuses

The processor unit, transceiver unit and hull unit carry fuses that protect the system from overvoltage and equipment fault. If the power cannot be applied, check the following.

- Check the fuse in the processor unit.
- Check the breaker in the power supply unit.
- Check the breaker in the transceiver unit. (The breaker is behind the lid front bottom corner.)

Find the cause before replacing a fuse. If the fuse blows again after replacement, contact your dealer for advice.

Unit	Type	Code No.	Remarks
Processor unit	FGBO1 250V 20A	000-155-775-10	For 12 VDC
	FGBO1 250V 10A PBF	000-155-787-10	For 24 VDC
Transceiver unit*	FGMB 250V 3A PBF	000-157-568-10	Internal DC voltage, 2 pcs.
	D52-8A	000-178-350-10	Internal B voltage, 1 pc.
	FGMB 250V 10A PBF	000-157-495-10	Internal B voltage, 2 pcs.
Hull unit*	FGMB 250V 2A PBF	000-157-497-10	HCTL board, 26 VDC/100 VAC, 3 pcs.
	FGMB 250V 1A PBF	000-157-496-10	Breaker output, 2 pcs.

\* Request serviceman to replace fuse.

WARNING

**Use the proper fuse.**

Use of a wrong fuse can cause fire or damage the equipment.

## 8.4 Battery on the Mother Board

The lithium battery on the Mother Board in the processor unit backs up data. When the voltage is too low, the processor unit will not start.

Name	Type	Code No.	Life
Lithium battery	ER3WKP	000-177-013-10	7 years

**Note 1:** Check the voltage regularly by doing the [Operation Test], on page 8-12. When the voltage is 2.9 V or less, the error code 322 appears. Have a qualified technician replace the battery.

**Note 2:** Dispose of the battery in accordance with local regulations. Tape the + and - terminals of the battery before disposal to prevent short circuit, which could cause a fire.

## 8.5 How to Clean the Filter

The units in the illustration below have vents with filters. Check the filters for dust accumulation and clean when necessary. If replacement of a filter is necessary contact your dealer.

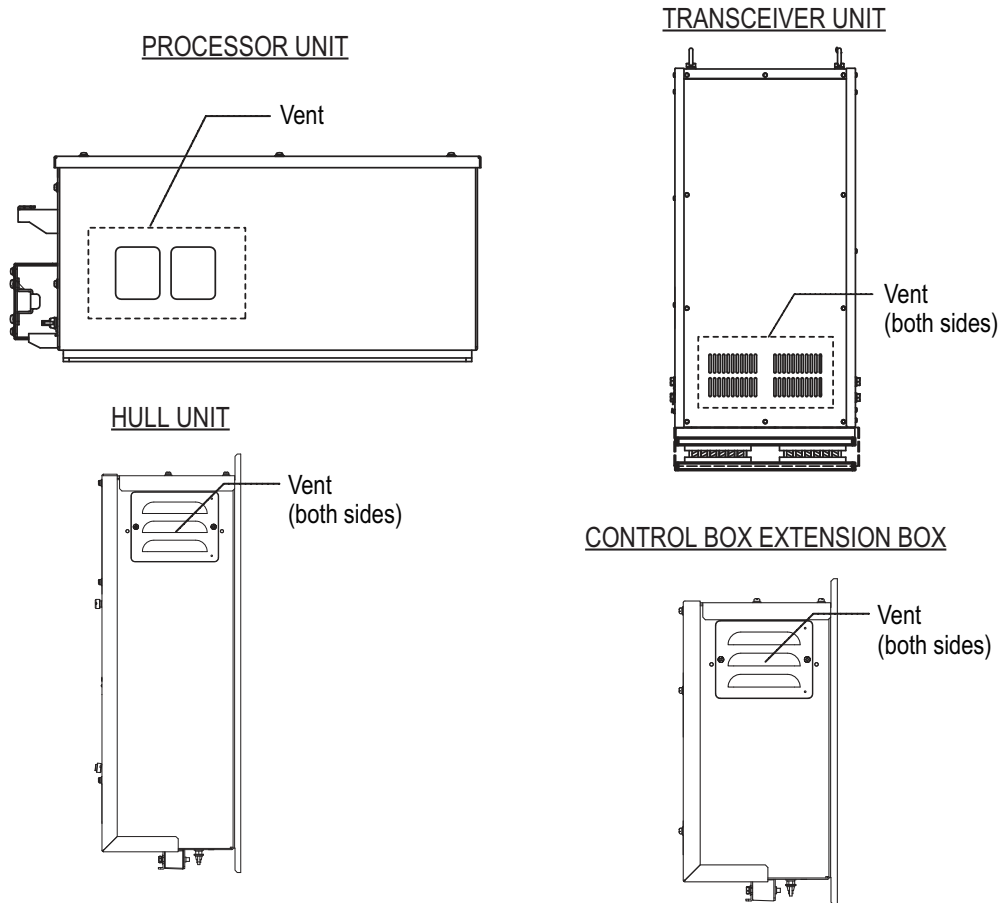

## 8.6 How to Clean the Trackball in the Control Unit

If the trackball does not roll smoothly it may require cleaning. Do the following to clean the trackball.

1. Turn the retaining ring on the trackball 45°.
2. Remove the retaining ring and ball.
3. Clean the ball with a soft lint-free cloth.
4. Blow carefully into the ball-cage to dislodge dust and lint. Look for a build-up of dirt on the metal rollers. If dirty, clean the rollers with a cotton swab moistened lightly with isopropyl-rubbing alcohol.
5. Make sure that fluff from the swab is not left on the rollers.
6. Replace the ball and retaining ring. Be sure the retaining ring is not inserted reversely.

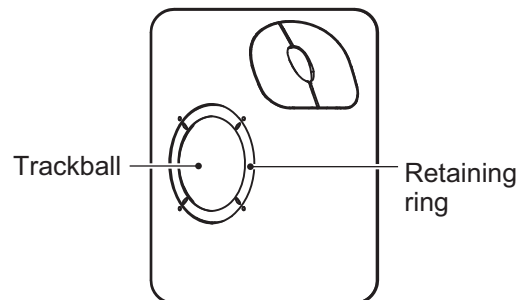

## 8.7 Troubleshooting

The table below provides common symptoms of equipment troubles and the means to rectify them.

### Troubleshooting

Symptom	Check, remedy
Cannot turn on power.	<ul style="list-style-type: none"> <li>• Check cables between transceiver unit, processor unit and monitor unit.</li> <li>• Check the fuses.</li> <li>• Check power source.</li> <li>• Check if the breaker in the power supply unit has tripped.</li> </ul>
Abnormal noise from hull unit	Check if the drive shaft in the hull unit is sufficiently greased. See section 8.2.
Bottom echo is unsteady.	<ul style="list-style-type: none"> <li>• Rough seas. Distance to the bottom changes due to rolling and pitching.</li> <li>• Long range selected. Transmission period is longer so ship's pitching and rolling are apt to affect detection of echo.</li> </ul>
Weak echoes	<ul style="list-style-type: none"> <li>• Output power set to minimum. Set [TX Power] to maximum, on the [TX/RX Setting] menu.</li> <li>• Adjust the <b>GAIN</b> control.</li> <li>• Excessive TVG. Readjust [Near Gain], [Far Gain]. See section 2.6.2.</li> </ul> <p><b>Note:</b> Readjustment of TVG is necessary after the gain is adjusted.</p>
Color is abnormal.	Brilliance setting too low. Increase brightness of the monitor.
Cannot operate the equipment	Application error. Long push the power switch on the control unit approx. 10 seconds to turn off the power. Turn on the power and check function.
Picture contains noise.	<ul style="list-style-type: none"> <li>• Equipment not grounded properly. Check equipment ground.</li> <li>• Power cable is too close to the signal cable. Relocate power cable or signal cable.</li> <li>• Debris may be on the sea surface. Reject unwanted noise with [Int Reject] in the [Picture Setting] menu or [Signal Level] in the [Display Setting] menu.</li> </ul>
Cannot turn off the power	Long push the power switch on the control unit approx. 10 seconds to turn off the power.
The fish alarm does not sound.	The alarm does not sound when the setting of [Echo Disp Area] (in the [Display Setting] menu) is changed. Re-set the alarm range to get the audio for the fish alarm.
The offcenter feature does not work.	<ul style="list-style-type: none"> <li>• When the true motion is used in the H2 mode, the range of the H1 and H2 displays is different.</li> <li>• Set the tilt angle to 0° when using the true motion.</li> </ul>

## 8.8 Warning Messages

The table below shows the warning messages which may appear on the display. All warning messages flash and are accompanied by an audio alarm, which you may silence with the **R/B AUDIO** key.

### Warning messages

Message	Meaning, Remedy
<b>Power supply</b>	
"<<OVERVOLTAGE!!>> RETRACT TRANSDUCER AND TURN OFF POWER. CHECK SHIP'S MAINS VOLTAGE. PRESS R/B KEY TO TURN OFF ALARM."	<b>Meaning:</b> The voltage supplied to the transceiver unit is excessive. Transmission is stopped if the equipment is transmitting, to protect the transducer and transmitter power section from damage. <b>Remedy:</b> Silence the buzzer with the <b>R/B AUDIO</b> key. Retract the transducer and turn off the power. Have a qualified technician check input voltage.
<b>Transceiver unit</b>	
"<<NO RESPONSE FROM TRANSCEIVER UNIT!!>> TURN OFF AND ON POWER AGAIN, OR CHECK POWER LINE TO TRANSCEIVER UNIT. PRESS R/B KEY TO TURN OFF ALARM."	<b>Meaning:</b> No response from the transceiver unit. <b>Remedy:</b> Silence the buzzer with the <b>R/B AUDIO</b> key. Reset the breaker on both the transceiver unit and power supply unit. If the breaker(s) trip again, have a qualified technician check the set.
"<<ELECTRIC CHARGE!!>> RETRACT TRANSDUCER AND TURN OFF POWER. PRESS R/B KEY TO TURN OFF ALARM."	<b>Meaning:</b> The +B voltage of capacitors in the transceiver unit could not be charged to specified voltage within the prescribed time. <b>Remedy:</b> Silence the buzzer with the <b>R/B AUDIO</b> key and turn off the power. Have a qualified technician check the set.
"<<OVER TEMPERATURE!!>> RETRACT TRANSDUCER AND TURN OFF POWER. PRESS R/B KEY TO TURN OFF ALARM."	<b>Meaning:</b> The temperature of the power block in the transceiver unit is more than 80°C (176°F). <b>Remedy:</b> Silence the buzzer with the <b>R/B AUDIO</b> key. Retract the transducer and turn off the power. Check if the vent on the unit is blocked. If the message appears again, have a qualified technician check the system.
<b>Hull unit, transceiver unit</b>	
"<<TRANSDUCER NOT RETRACTED!!>> CUT OFF POWER LINE TO PROCESSOR, TRANS- CEIVER AND HULL UNIT. PRESS R/B KEY TO TURN OFF ALARM."	<b>Meaning:</b> The transducer is not raised within 20 seconds (1200 mm stroke) or 25 seconds (1600 mm stroke) with the ↑ key. <b>Remedy:</b> Silence the buzzer with the <b>R/B AUDIO</b> key. The reason may be the transducer is tangled in the net, its shaft is bent, or raise/lower function is abnormal. Try raising the transducer from the hull unit. See section 8.12.

Message	Meaning, Remedy
"<<TD WRONG POSITION ALARM!!>> TRANSDUCER IS KEPT AT WRONG POSITION. SET BACK TRANSDUCER POSITION TO NORMAL BY USING ↑ KEY. PRESS R/B KEY TO TURN OFF ALARM."	<b>Meaning:</b> The transducer is not at its intended position. <b>Remedy:</b> Silence the buzzer with the <b>R/B AUDIO</b> key. Use the ↑ key to try to return the transducer to its intended position.
"<<OVER TEMPERATURE!!>> RETRACT TRANSDUCER AND TURN OFF POWER. PRESS R/B KEY TO TURN OFF ALARM."	<b>Meaning:</b> The temperature at the transducer is too high. <b>Remedy:</b> Silence the buzzer with the <b>R/B AUDIO</b> key. Use the ↑ key to raise the transducer. Turn off the system.
"<<TRANSDUCER IS A HALT CONDITION!!>> TD IS A HALT CONDITION. CAN'T BE OPERATED UNTIL IT CANCELS. CHECK STOP BUTTON IS PUSHED OR TAKE OUT HULL UNIT RATCHET."	<b>Meaning:</b> The hull unit is stopped because the emergency stop button in the hull unit was operated or the ratchet wrench in the hull unit was removed. <b>Remedy:</b> Silence the buzzer with the <b>R/B AUDIO</b> key. Operate the emergency stop button and/or restore the ratchet wrench to enable raising, lowering operations.
"<<TD RECOVERED THE HALT CONDITION!!>> TD RECOVERED THE HALT CONDITION. PRESS ↑↓ KEY, IF SAFETY IS ENSURED. PRESS THE R/B KEY TO CLOSE THE WINDOW."	<b>Meaning:</b> The emergency stop condition at the hull unit was released. <b>Remedy:</b> Silence the buzzer with the <b>R/B AUDIO</b> key.
"<<SHIP SPD ALARM!!>> TD IS KEPT EXTENDED. MAX ALLOWABLE SPEED FOR EXTENDED TRANSDUCER IS XX.X KN. RE- TRACT TRANSDUCER. PRESS R/B KEY TO TURN OFF ALARM."	<b>Meaning:</b> The transducer is kept lowered when the ship's speed (external input) exceeds the maximum allowable speed. <b>Remedy:</b> Silence the buzzer with the <b>R/B AUDIO</b> key. Lower speed then retract the transducer.
"<<SHIP SPD ALARM!!>> MAX ALLOWABLE SPEED FOR RAISING/LOWERING TRANSDUCER IS XX.X KN. PRESS R/B KEY TO TURN OFF ALARM."	<b>Meaning:</b> The transducer is raised/lowered and ship's speed, input by external equipment, exceeds maximum allowable speed. <b>Remedy:</b> Silence the buzzer with the <b>R/B AUDIO</b> key. Lower speed, or lower speed and retract transducer.

When multiple warnings occur at the same time, the warning with the highest priority is displayed. The order of priority is as follows:

Priority	Message	Remarks
1	"TRANSDUCER IS A HALT"	Message remains on screen until problem is cleared.
2	"TRANSDUCER NOT RETRACTED"*	Message remains on screen until problem is cleared.
3	"OVER VOLTAGE"	
4	"OVER TEMPERATURE"*	Message remains on screen until problem is cleared.
5	"OVER TEMPERATURE"	
6	"ELECTRIC CHARGE"*	Message remains on screen until problem is cleared.
7	"NO RESPONSE FROM TRANSCEIVER UNIT"	

\*: These messages are not erased even if a message of higher priority arrives.

## 8.9 Error Codes

The equipment displays a (blinking) three-digit error code at the bottom of the display when it detects internal trouble. In case of multiple error, error codes appear in numerical order and the maximum number of error codes is five. The codes remain on the screen until the corresponding trouble is fixed, and a buzzer sounds each time a new error code is added to the on-screen error code display. For any error code, report error code number to your dealer.

\* \* \* Error Code \* \* \* #003, #006, #108

## 8.10 Status Messages

Status messages appear at the screen center to alert the operator. These are as below.

### Status messages and their meanings

Status message	Meaning
"TX OFF"	Transmission turned off from the menu.
"RAISE/LOWER TEST"*	Raise/lower command received from the control unit in normal operation, to manually test raise/lower switch in hull unit. Raise/lower keys on the control unit are inoperative during the hull unit test.
"UNREGISTERED"	The transducer position mark cannot display transducer position because transducer position has not been registered. Ask your dealer to register transducer position.

\* Not displayed when TX is OFF.



## 8.11 Tests

A comprehensive diagnostic facility is provided for testing the equipment. If you feel the equipment is not working properly, conduct the test to find the cause. Check that the system is correctly connected before doing any test.

If NG (No Good) appears in the test results for any test, contact your dealer for advice.

### 8.11.1 How to display the Test menu

1. Press the **MENU/ESC** key to show the main menu.
2. Click [Others].
3. Click [Initial Setting]
4. Click [Changeable].
5. Click [Test].

Test		Quit
Operation Test ...	: Execute	
Board Test ...	: Execute	
Panel Test ...	: Execute	
Test Pattern ...	: Execute	
RX Test* ...	: Execute	
FAN MONITOR	: Execute	
TX	: OFF	

\*For technician

**Note:** The menu item [TX] turns transmission on or off. Turn off transmission to identify the source of noise, for example.

### 8.11.2 Operation test

The operation test checks the system for proper operation. Select [Operation Test] from the [Test] menu to do this test.

OPERATION TEST

<p>FSV-2503    105-0926-XX.XX ← ① (or 105-0896-XX.XX)</p> <p>RAM        = OK EW         = Enable CAN Unique No. = USB        = USB        = Monitor1   = 1280x1024 Monitor2   =</p> <p>LAN MAC address = *****</p> <p>HDD        = ***** PCI        = *****</p> <p>CPU Temperature = 32.0°C ③ BOARD Temperature = 20.0°C CPU Fan Speed   = 4800rpm BATTERY        = 3.2V ②</p> <p>FSV-8502    105-XXXX-XX.XX S1 00000000(0)               105-XXXX-XX.XX S2 00000000(0)               105-XXXX-XX.XX               ROM = OK               RAM = OK               LAN MAC address = *****</p> <p>FSV-2501    105-XXXX-XX.XX S1 1111(F)               105-XXXX-XX.XX               105-XXXX-XX.XX</p> <p>              ROM = OK               RAM = OK</p> <p>              LAN MAC address = *****</p>	<p>TRCPU-0    105-0894-XX.XX</p> <div style="border: 1px dashed black; padding: 5px; margin: 5px 0;"> <p>④ → ROM = OK RAM = OK S2 00000000(40) DATA = OK S3 00010000(10)</p> <p>LAN MAC address = *****</p> </div> <p>TRX         0000000000</p> <p>PWR         12V = 12.1V               +B = 200.5V ← ⑤</p> <p>INC         TEST = OK               ↑               PITCH = +12.3               ⑥               ROLL = - 2.5</p> <p>TD         00               TEMP = 76.4°C</p> <p>              Position = 1450 mm (91)               UP_LSW = 0 mm (0)               HTX_SW = 1000 mm (62)               LTX_SW = 1300 mm (81)               DN_LSW = 1600 mm (100)</p> <p>FSV-2501    105-XXXX-XX.XX S1 1111(F)               105-XXXX-XX.XX               105-XXXX-XX.XX</p> <p>              ⑦ ↑               ROM = OK               RAM = OK</p> <p>              LAN MAC address = *****</p>
---	---

Press MENU/ESC key to cancel.

OK: Normal, NG: Error  
XX: Version No.

For any NG, contact your dealer for advice.

#### How to read the test results

No.	Description
(1)	Program no. (displayed in white). Abnormal number shown in red.
(2)	Voltage of the lithium battery on the Mother board, which backs up data. If the voltage is 2.6 V or less, have a qualified technician replace the battery.
(3)	DIP switch setting on each board
(4)	Memory read/write test. Result is shown as "OK" (white) or "NG" (red).
(5)	+B voltage
(6)	Inertial measurement unit test results. Result is shown as "OK" (white) or "NG" (red).
(7)	No.2 control unit check results.

### 8.11.3 Board test

The board test checks all the circuit boards in the system. Select [Board Test] from the [Test] menu to do this test.

BOARD TEST

---

① → TRCPU 105-0899-XX.XX 105-0900-XX.XX 105-0894-XX.XX Revision = 0	ROM = OK RAM = OK FRAM = OK TDS = OK FDS = OK	TFP = OK RFP = OK FFP = OK R2F = OK	FANMON 105-0889-XX.XX HCTL 105-0892-XX.XX Revision = 0
② → TRX1 105-0890-XX.XX Revision = 0 12V = OK	ROM = OK RAM = OK TFP = OK T2R = OK	TRX2 105-0890-XX.XX Revision = 0 12V = OK	ROM = OK RAM = OK TFP = OK T2R = OK
TRX3 105-0890-XX.XX Revision = 0 12V = OK	ROM = OK RAM = OK TFP = OK T2R = OK	TRX4 105-0890-XX.XX Revision = 0 12V = OK	ROM = OK RAM = OK TFP = OK T2R = OK
TRX5 105-0890-XX.XX Revision = 0 12V = OK	ROM = OK RAM = OK TFP = OK T2R = OK	TRX6 105-0890-XX.XX Revision = 0 12V = OK	ROM = OK RAM = OK TFP = OK T2R = OK
TRX7 105-0890-XX.XX Revision = 0 12V = OK	ROM = OK RAM = OK TFP = OK T2R = OK	TRX8 105-0890-XX.XX Revision = 0 12V = OK	ROM = OK RAM = OK TFP = OK T2R = OK
TRX9 105-0890-XX.XX Revision = 0 12V = OK	ROM = OK RAM = OK TFP = OK T2R = OK	TRX10 105-0890-XX.XX Revision = 0 12V = OK	ROM = OK RAM = OK TFP = OK T2R = OK

Press MENU/ESC key to cancel.

OK: Normal, NG: Error  
 XX: Version No.

For any NG, contact your dealer for advice.

#### How to read the test results

No.	Description
(1)	TRCPU board program no.
(2)	TRX board program no.

### 8.11.4 Panel test

The panel test checks the keys, controls and trackball of the control unit. Select [Panel Test] from the [Test] menu to do this test.

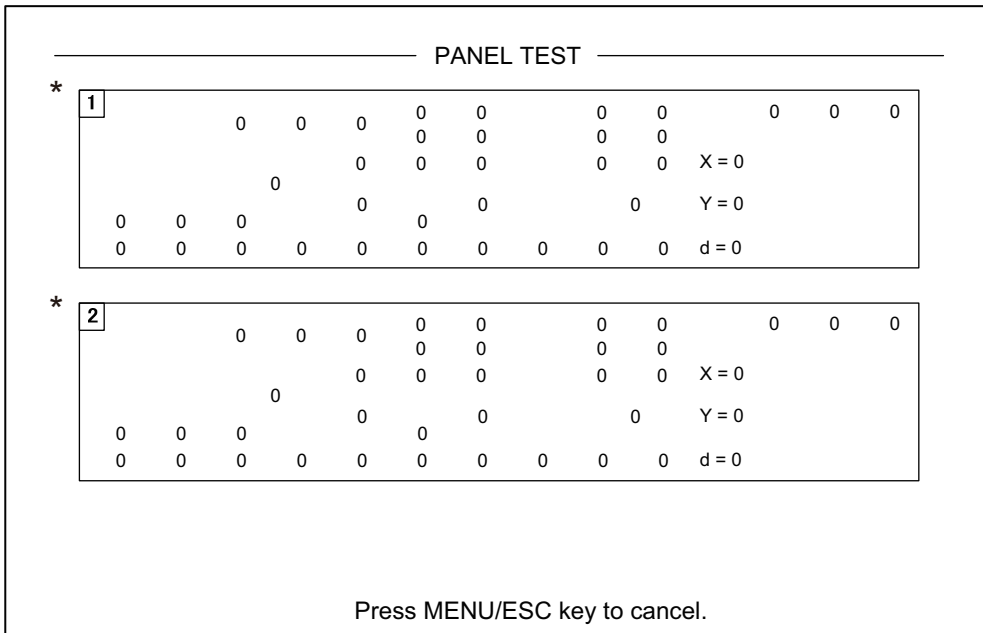

\*When two control units are connected, 1 is for main control unit and 2 is for sub control unit.

**Key check:** Press each key one by one. A key is normal if its corresponding on-screen location shows 1 while the key is pressed and 0 when the key is released. The power keys (ON and OFF) can not be checked. Spin the scrollwheel. The indication at “d” is a positive number when the wheel is spun upward; a negative number when spun downward.

**Control check:** Operate each control one by one. A control is normal if;  
 Clockwise rotation: Positive value  
 Counterclockwise rotation: Negative value  
 No rotation: “0”

**Lever check:** Press the lever upward or downward. Normal conditions are 1 for upward and 2 for downward.

**Trackball check:** Operate the trackball. X-Y coordinates of trackball position are displayed. Normal conditions are as follows.  
 Rightward: X positive, Leftward: X negative  
 Upward: Y positive, Downward: Y negative

### 8.11.5 Test pattern

The test pattern checks for proper display of colors. Click [Test Pattern] on the [Test] menu. Push the **DISP MODE** key to change the test pattern.

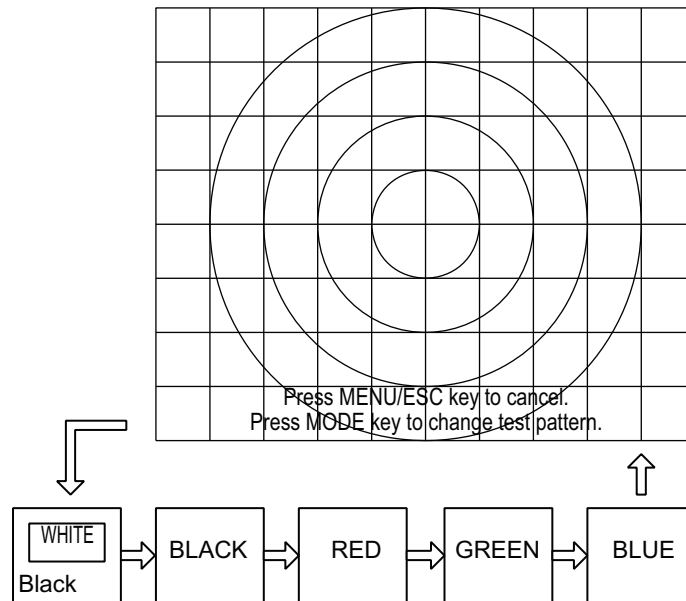

### 8.11.6 Fan monitor test

The [FAN MONITOR] test checks the fans in the units of the system for proper rotation speed. Select [FAN MONITOR] from the [Test] menu to do this test.

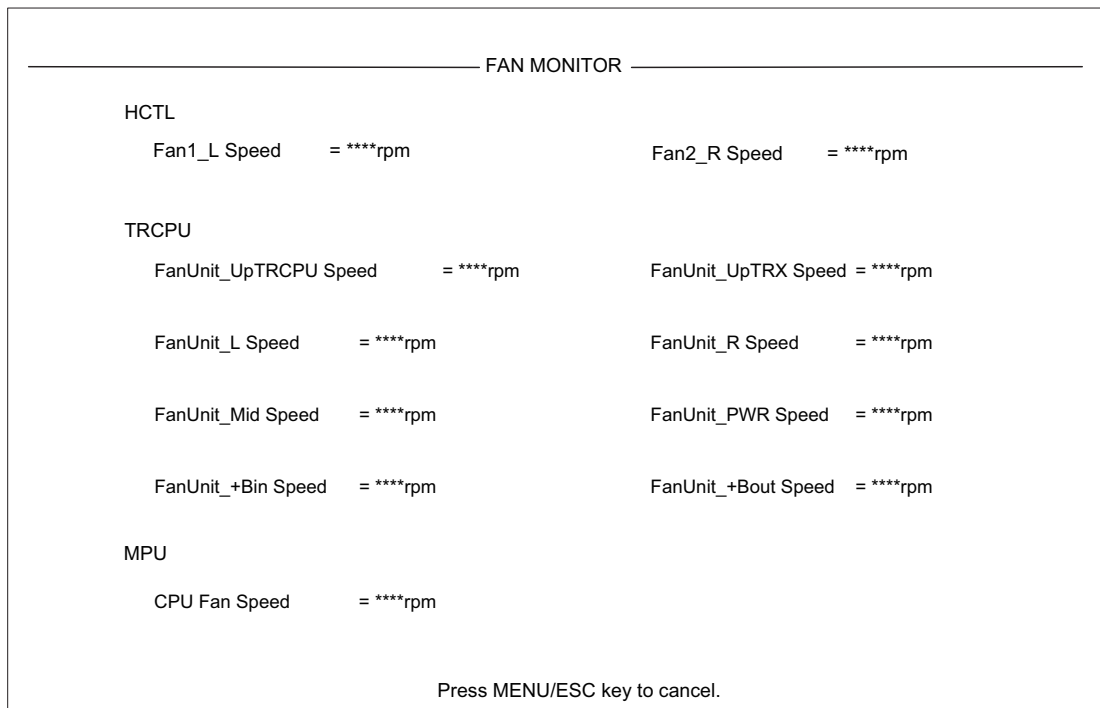

## 8.12 How to Raise the Transducer from the Hull Unit

If the transducer cannot be raised with the switches on the control unit, because it is tangled in the net or its shaft is bent, try to raise it from the hull unit, automatically or manually, whichever works.

This procedure is intended for the service technician.

### 8.12.1 How to raise the transducer automatically

If the message "TRANSDUCER NOT RETRACTED" appears, and the transducer cannot be retracted from the control unit, do as follows:

1. Check the LEDs on the hull unit.  
When the L.SW\_LED on the raise/lower control box flashes, the raise/lower function may be abnormal. Do the following steps to raise the transducer, then contact your dealer. When you can not check the LEDs, go to step 2.
2. Turn off the switchboard, transceiver unit and hull unit from the ship's mains breaker.  
To force a system shut-down, press and hold the POWER ON (I) switch for approx. 10 seconds.
3. Check if the net or other object is caught in the transducer.
4. Look through the lid on the raise/lower control box in the hull unit to check if the motor breaker is OFF. If it is midway between ON and OFF, open the lid and turn it off and then on.
5. Unfasten six screws to remove the cover of the raise/lower control box.

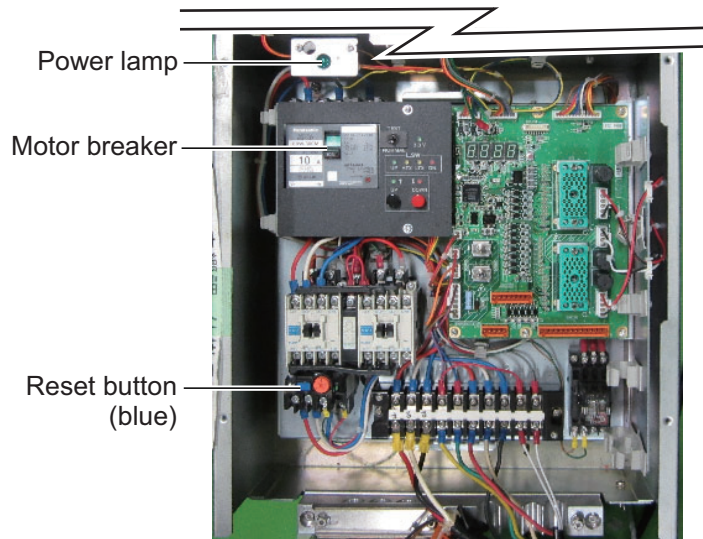

6. Push the RESET button (green) on the raise/lower control box.

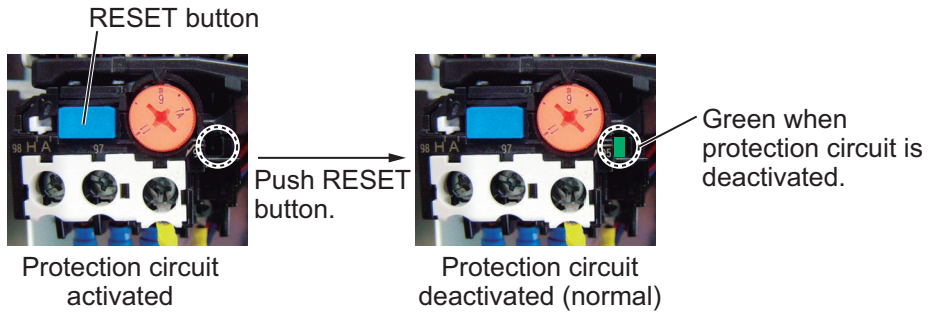

7. Close the cover.
  8. Turn on the breaker at the ship's mains.  
If you force quit the system at step 1, go to the step 8.
  9. Turn on the system from the control unit.
  10. Press the  key on the control unit to raise the transducer.
- If the transducer cannot be raised, the shaft may be bent. In this case raise it manually with the ratchet wrench, following the instructions in the next section.

### 8.12.2 How to raise the transducer manually



## WARNING

Before operating the hull unit manually, check that the motor brake and shaft are working properly. See section 8.13.1.

Follow the procedure below to raise the transducer manually.

1. Open the lid on the raise/lower control box of the hull unit and turn off the motor breaker. Confirm that the power lamp is off. (See the illustration on page 8-16 for the location of those parts.)
2. Unscrew the motor shaft cover. See (a).
3. Attach the ratchet wrench to the motor shaft. See (b).
4. While holding the ratchet wrench, pull the release lever toward you and upward to release the brake. See (c).

**Note:** Hold the ratchet wrench when releasing the brake, to prevent the transducer from falling.

5. Turn the ratchet wrench clockwise to raise the transducer. See (d).
6. After retracting the transducer into the tank, set the release lever to the holder. See (e).
7. Remove the ratchet wrench and return it to its holder. Restore the motor brake to its normal position.

**Note:** Be sure to return the ratchet wrench to its holder. Otherwise the hull unit will be stopped and the transducer cannot be raised or lowered.

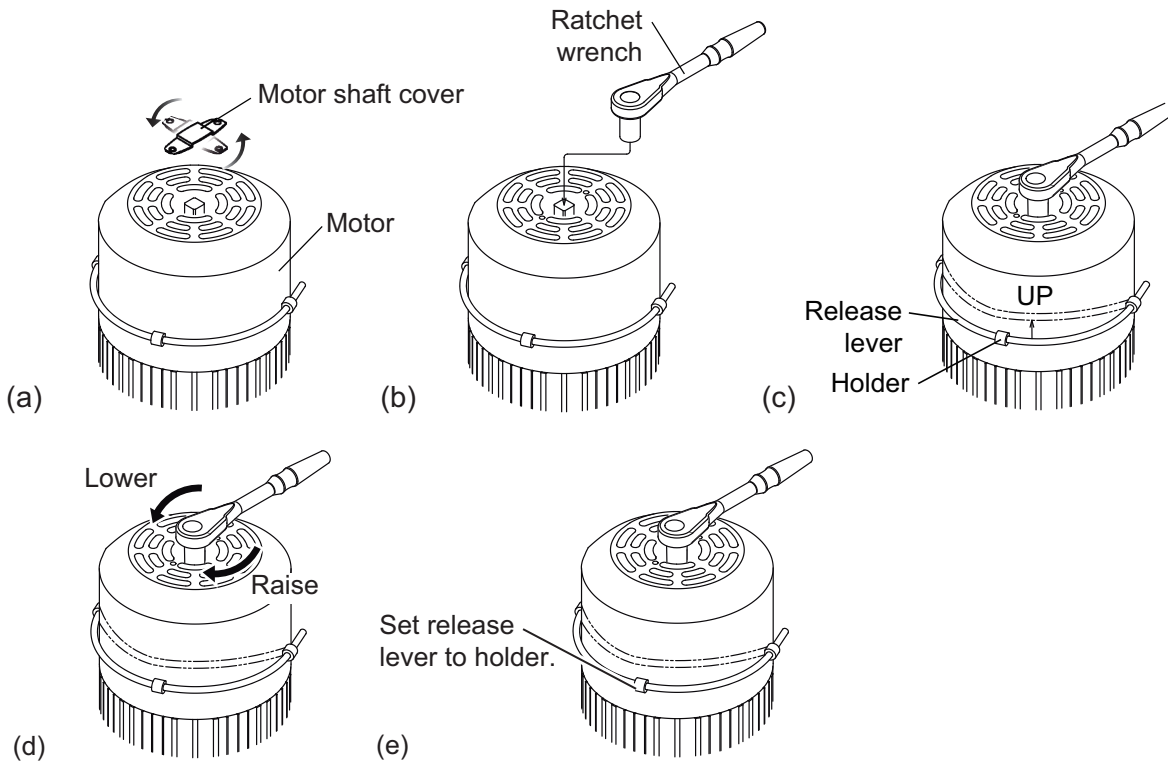



## 8.13 How to Check the Brake in the Hull Unit

The main shaft in the hull unit has two brakes, motor brake and drive shaft brake. Have a qualified technician check the brakes yearly.

**Before doing the check, make sure no one is near the hull unit and transducer.**

**Note:** Record the check result in the brake check sheet at appendix 2.

### 8.13.1 How to check the brake in the raise/lower control box

1. Unfasten six screws to remove the cover from the raise/lower control box in the hull unit.

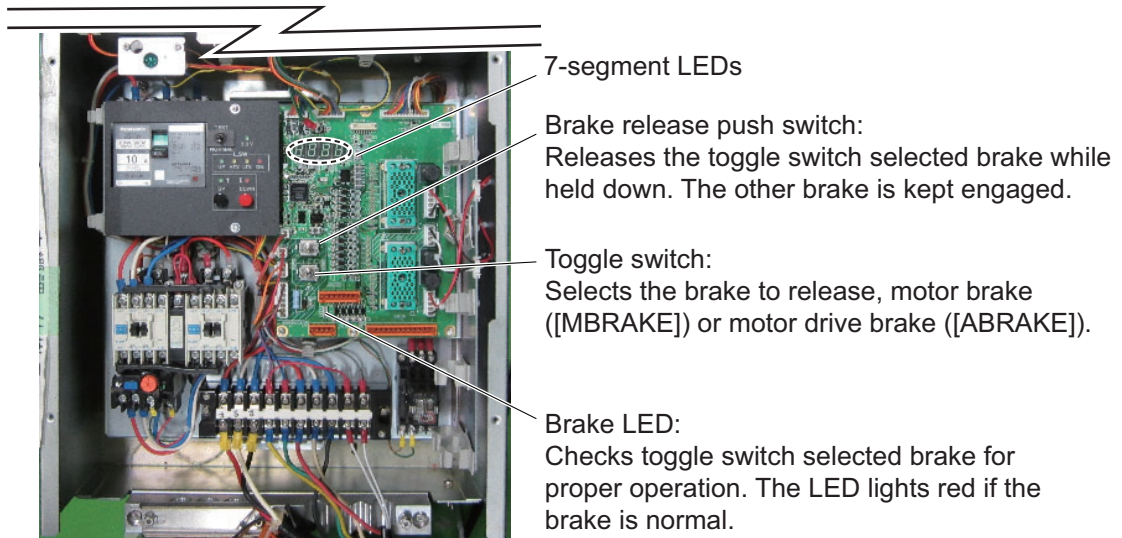

2. Set the toggle switch to the ([MBRAKE]) side.
3. Check that the Brake LED on the circuit board is lit. The LED does not light when the motor break control circuit is abnormal. If the LED is OFF, return the toggle switch to its original position and contact your dealer for advice.
4. Set the toggle switch to the [MBRAKE] position. Hold down the brake release push switch to release the motor brake. Check that the main shaft does not lower and the 7-segment LEDs on the circuit board does not change. If the main shaft lowers or the LED lighting pattern changes, release the brake release push switch. The drive shaft brake is abnormal; check the drive shaft brake.
5. Set the toggle switch to the ([ABRAKE]) side.
6. Check that the Brake LED on the circuit board is lit. The LED does not light when the drive shaft gear brake control circuit is abnormal. If the LED is OFF, return the toggle switch to its original position and contact your dealer for advice.
7. Hold down the brake release push switch to release the drive shaft gear. Check that the main shaft does not lower and the 7-segment LEDs on the circuit board does not change. If the main shaft lowers or the LED lighting pattern changes, release the brake release push switch. The motor brake is abnormal; check the motor brake.

### 8.13.2 How to measure the gap in the motor brake

1. Pull the brake release lever toward you then push the lever upward.

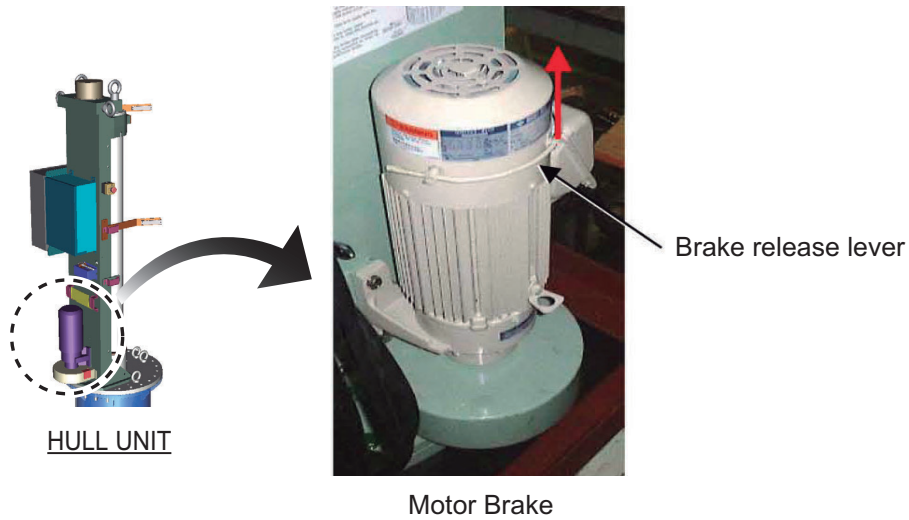

2. Use a radio pincers to remove two circlips from the brake release lever.

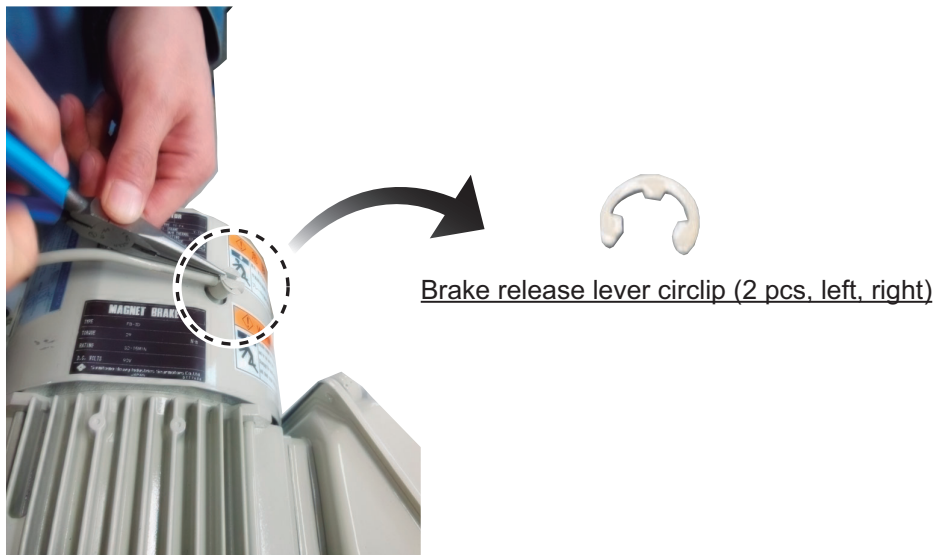

3. Remove the brake release lever.
4. Unfasten three bolts from the motor brake cover.

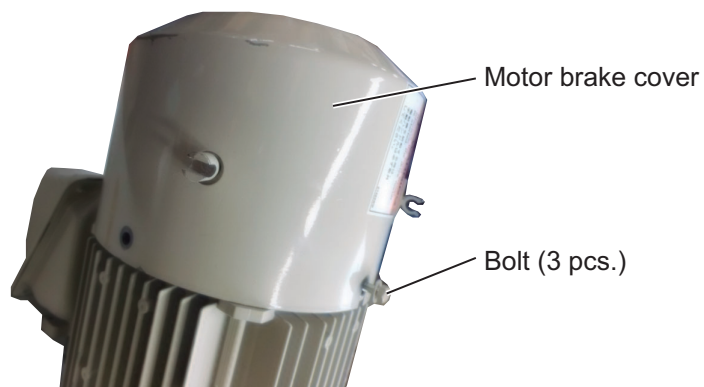

5. Use a radio pincers to remove two lock pins (left, right).



6. Remove the motor brake cover.
7. Unfasten two bolts (left, right) to access the waterproofing gasket. Remove the gasket.



8. Loosen a set screw to remove the fan.

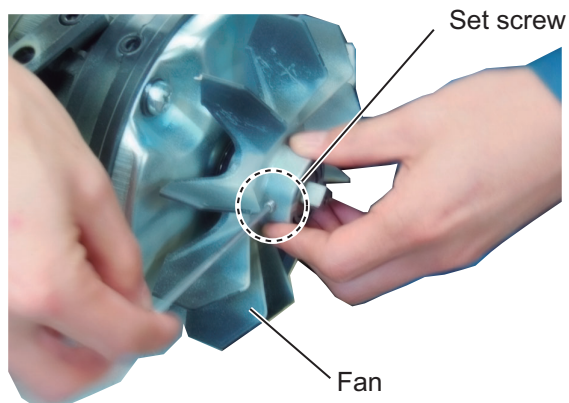

## 8. MAINTENANCE, TROUBLESHOOTING

9. Unfasten three screws to remove the waterproofing cover.



10. Use a gap gauge to measure the gap between the fixed core and the moving core.

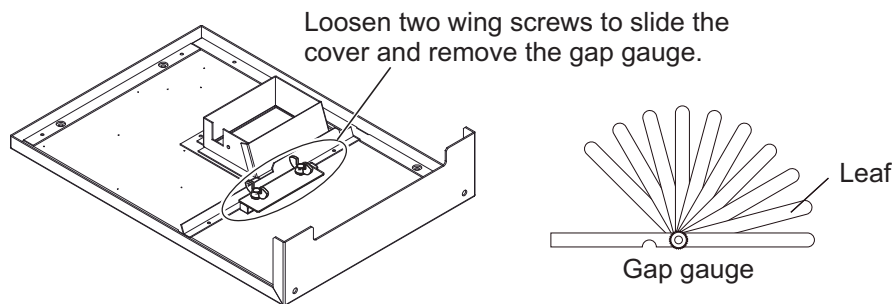

Insert the leaf of the gap gauge horizontally to the place of measurement. Take the measurement. Measure the gap at three places.

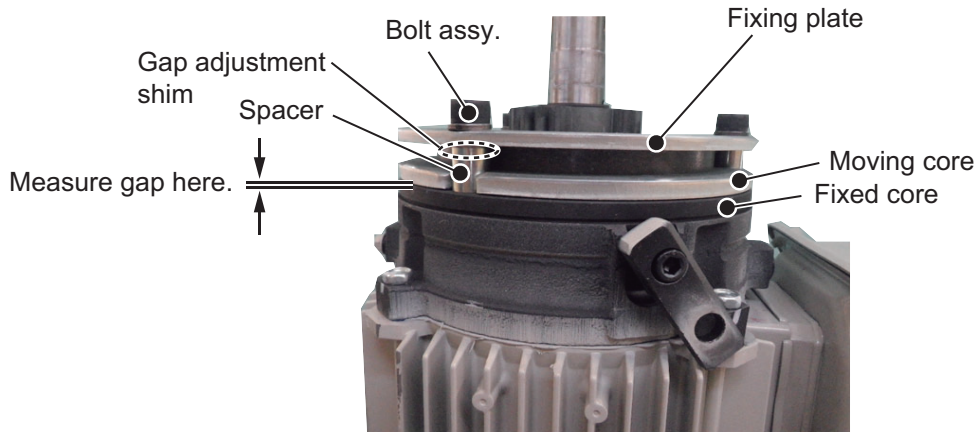

11. If the gap measured at step 10 is approx. 0.7 mm, do the following to reduce the gap. (If you can insert the 0.7 mm leaf, do steps 1) to 3) below.)
  - 1) Loosen three bolt assy. to remove spacer, gap adjustment shim, bolt assy., and fixing plate.  
**Note:** Be careful not to loose the gap adjustment shim.
  - 2) Reduce the amount of gap adjustment shims (thickness of shim: approx. 0.2 mm), then install the spacer, gap adjustment shim, bolt assy. and fixing plate.
  - 3) Measure the gap. The gap must be between 0.3 and 0.4 mm. (Confirm that the 0.3 mm leaf can be inserted, but the 0.4 mm leaf cannot.)
12. Reassemble the motor brake. Coat the set bolt for the fan with thread-locking fluid.

### 8.13.3 How to measure the gap in the drive shaft gear

1. Unfasten six screw to remove the drive shaft gear cover.

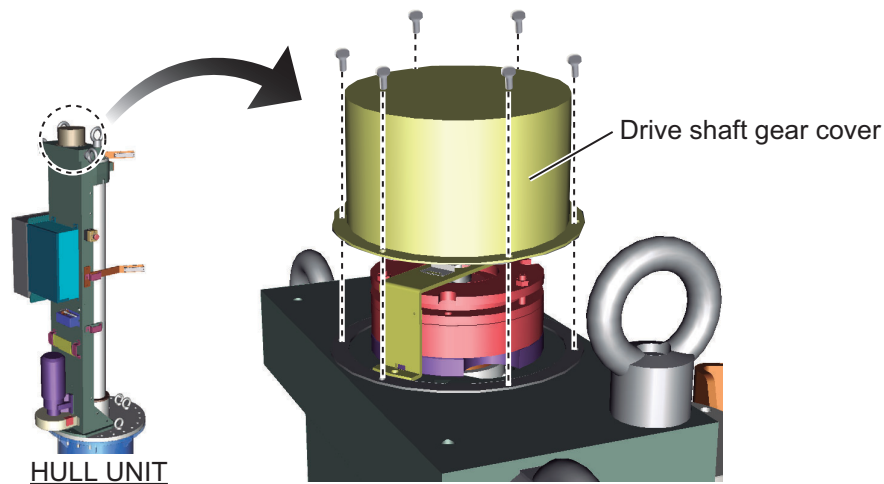

2. Use a gap gauge to measure the gap between the fixed core and moving core. See the preceding page. Insert the leaf of the gap gauge horizontally to the place of measurement. Take the measurement. Measure the gap at three places.

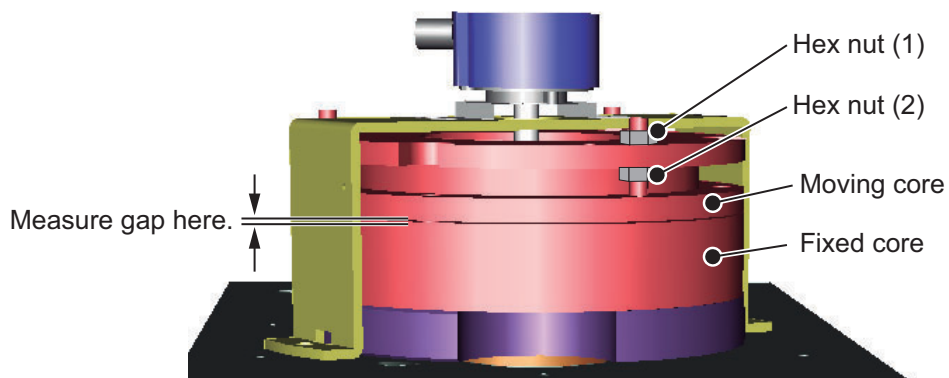

3. If the gap measured at step 2 is approx. 0.65 mm, do the following to reduce the gap. (If the 0.6 mm leaf can be inserted, do steps 1) to 5) below.)
  - 1) Check that the motor brake release lever is locked.
  - 2) Loosen hex nut (2) (3 places) so the gap between the moving core and fixed core is 0.15 to 0.3 mm.
  - 3) Tighten hex nut (1) (3 places) so the gap is 0.15 to 0.30 mm. (Confirm that the 0.2 mm leaf can be inserted, but the 0.3 mm leaf cannot.)
  - 4) Tighten hex nut (2).
  - 5) Check that the gap is between 0.15 and 0.30 mm.
4. Fasten the drive shaft gear cover.

## 8. MAINTENANCE, TROUBLESHOOTING

**Note:** Be sure the cover gasket is correctly seated when fastening the drive shaft gear cover.

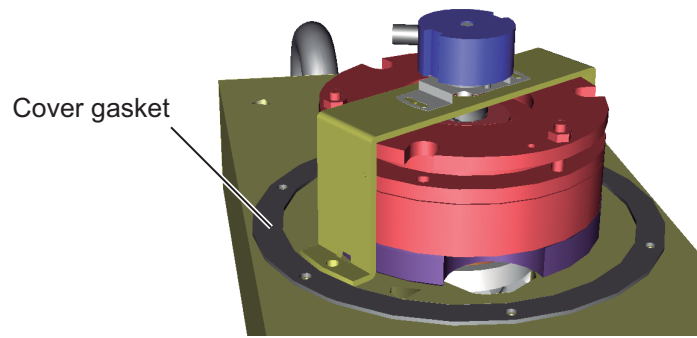

# APPENDIX 1 MENU TREE

## [MENU/ESC] key

- TX/RX Setting
  - U: No /F: Yes
    - TX Interval (1~9, Random 1~Random4, External Sync; **9**) [H1], U: Yes/F: Yes
    - TX Pulse Length (0~9; **9**) [H1/H2/V], U: Yes/F: Yes
    - TX Power (0~9; **9**) [H1/H2/V], U: Yes/F: Yes
    - Reverberation (0~3; **0**) [H1/H2/V], U: Yes/F: Yes
    - Freq Shift (-20~20; **0**) [H1/H2/V], U: Yes/F: Yes
    - Hor. Beam Wid (0~4, **4**) [H1/H2/V], U: Yes/F: Yes
    - Ver. Beam Wid (0~4, **4**) [H1/H2/V], U: Yes/F: Yes
  
- Gain Setting
  - U: No /F: Yes
    - TVG Curve (0~40log; **15log**) [H1/H2/V], U: Yes/F: Yes
    - Near Gain (0.0~10.0; **5.0**) [H1/H2/V], U: Yes/F: Yes
    - Near Gain Distance (20~1600 m; **400 m**) [H1/H2/V], U: Yes/F: Yes
    - Far Gain (0.0~10.0; **5.0**) [H1/H2/V], U: Yes/F: Yes
    - Far Gain Distance (20~1600 m; **400 m**) [H1/H2/V], U: Yes/F: Yes
    - AGC Near (0.0~10.0; **4.0**) [H1/H2/V], U: Yes/F: Yes
    - AGC Far (0.0~10.0; **4.0**) [H1/H2/V], U: Yes/F: Yes
    - AGC Distance (20~5000; **20m**) [H1/H2/V], U: Yes/F: Yes
    - Noise Suppress (0.0~10.0; **2.0**) [H1/H2/V], U: Yes/F: Yes
    - Noise Supp. (SHIP) (0.0~10.0; **0.0**) [H1/H2/V], U: Yes/F: Yes
  
- Display Setting
  - U: No /F: Yes
    - Noise Limiter (0~10; **0**) [H1/H2/V], U: Yes/F: Yes
    - Signal Level (0~31; **4**) [H1/H2/V], U: Yes/F: Yes
    - Color (Color 1, **Color 2**, Color 3, Color 4) [H1/H2/V], U: Yes/F: Yes
    - Color Response (**Color Curve 1**, Color Curve 2, Color Curve 3, Color Curve 4) [H1/H2/V], U: Yes/F: Yes
    - Color Setting [H1/H2/V], U: No/F: No
    - Color Curve Setting [H1/H2/V], U: No/F: No
  
- Picture Setting
  - U: No /F: Yes
    - Echo Average (0~11; **3**) [H1/H2/V], U: Yes/F: Yes
    - Int Reject (0~3; **2**) [H1/H2/V], U: Yes/F: Yes
    - Int Reject (ES) (0~3; **1**) [H1/H2/V], U: Yes/F: Yes
    - Smooth Echo RNG (0~5; **2**) [H1/H2/V], U: Yes/F: Yes
    - Smooth Echo CIR (0~4; **0**) [H1/H2/V], U: Yes/F: Yes
    - 2nd Echo Rej. (0~10; **0**) [H1], U: No/F: Yes
  
- Others
  - U: No /F: Yes
    - Erase Marks
      - U: No /F: Yes
        - Event Mark1 (Execute), U: Yes/F: Yes
        - Event Mark2 (Execute), U: Yes/F: Yes
        - Fish Mark (Execute), U: Yes/F: Yes
        - Own Ship Pos Mark (Execute), U: Yes/F: Yes
        - Ship's Track (Execute), U: Yes/F: Yes
    - Wheel Setting
      - U: No /F: Yes
        - H Mode (**Tilt Angle**, Range, Gain), U: Yes/F: Yes
        - V Mode (Range, Gain, **Bearing**), U: Yes/F: Yes
        - Wheel (Normal, **Reverse**), U: Yes/F: Yes
    - Mid Key Setting (**Fixed Position**, Any Position), U: No/F: No

①

②

U: Items which can be programmed to the user menu.  
F: Items which can be programmed to a function key.

Default settings in bold italic. Note that default settings change depending on the setting for user program.

APPENDIX 1 MENU TREE

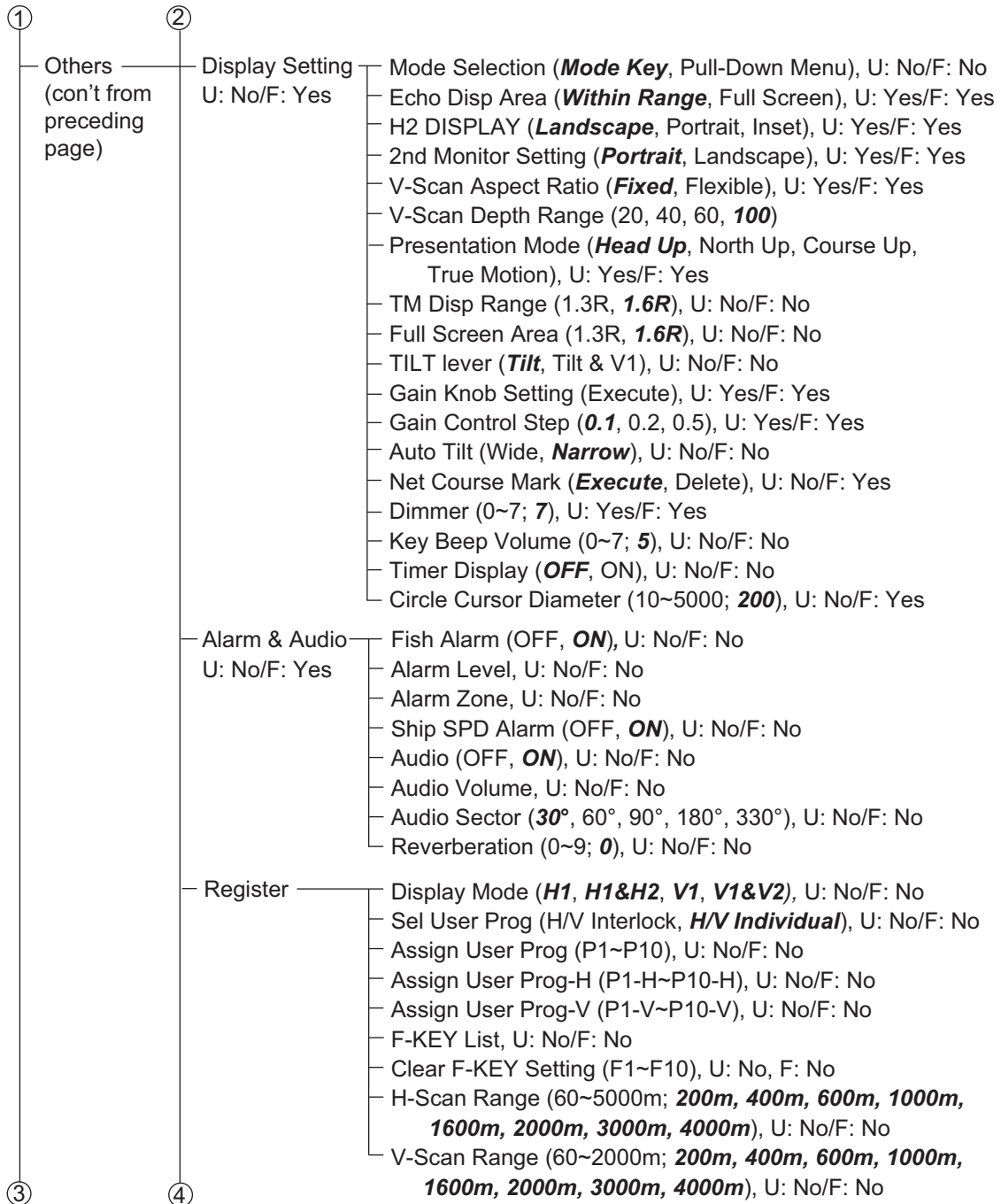



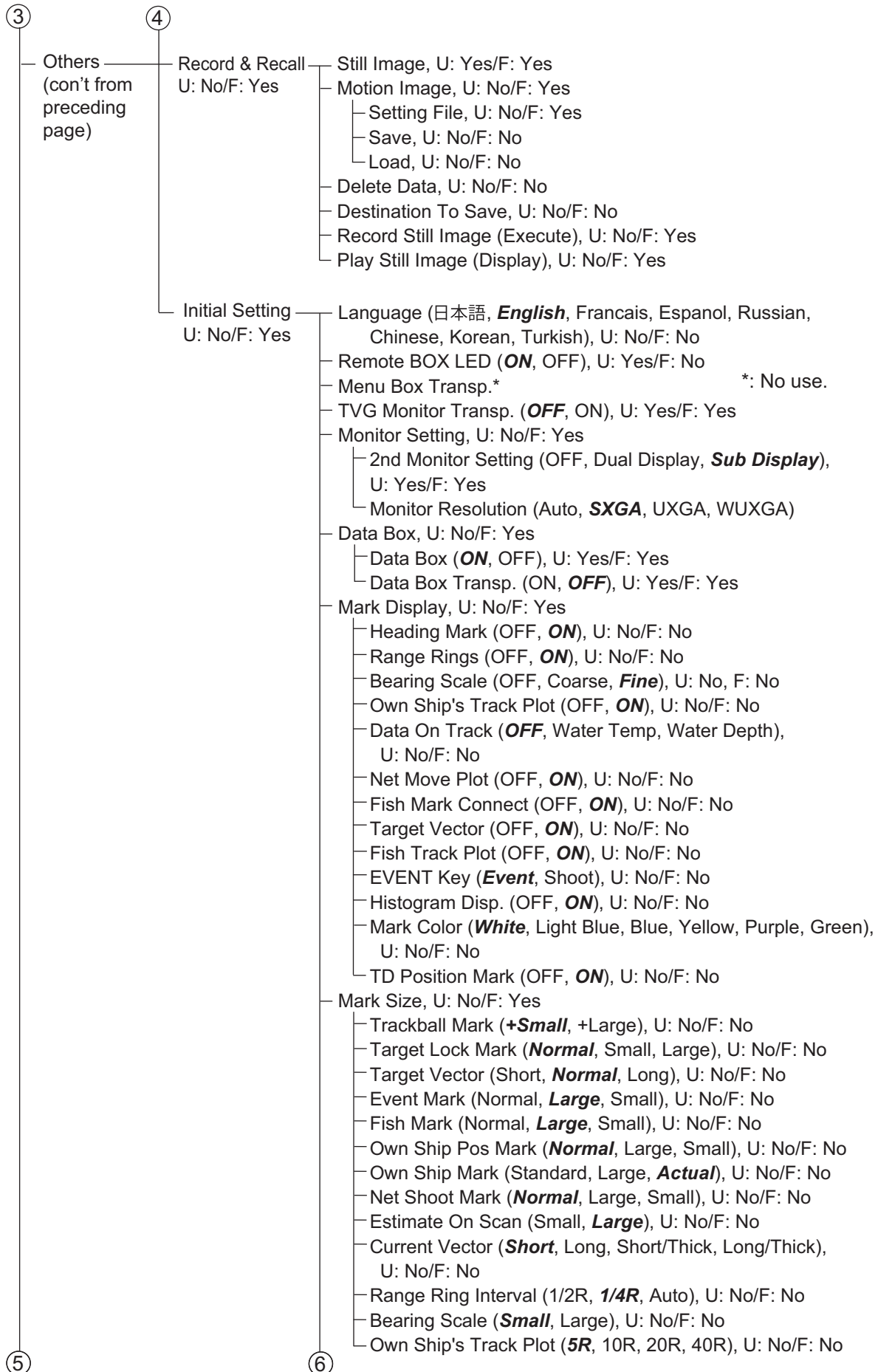

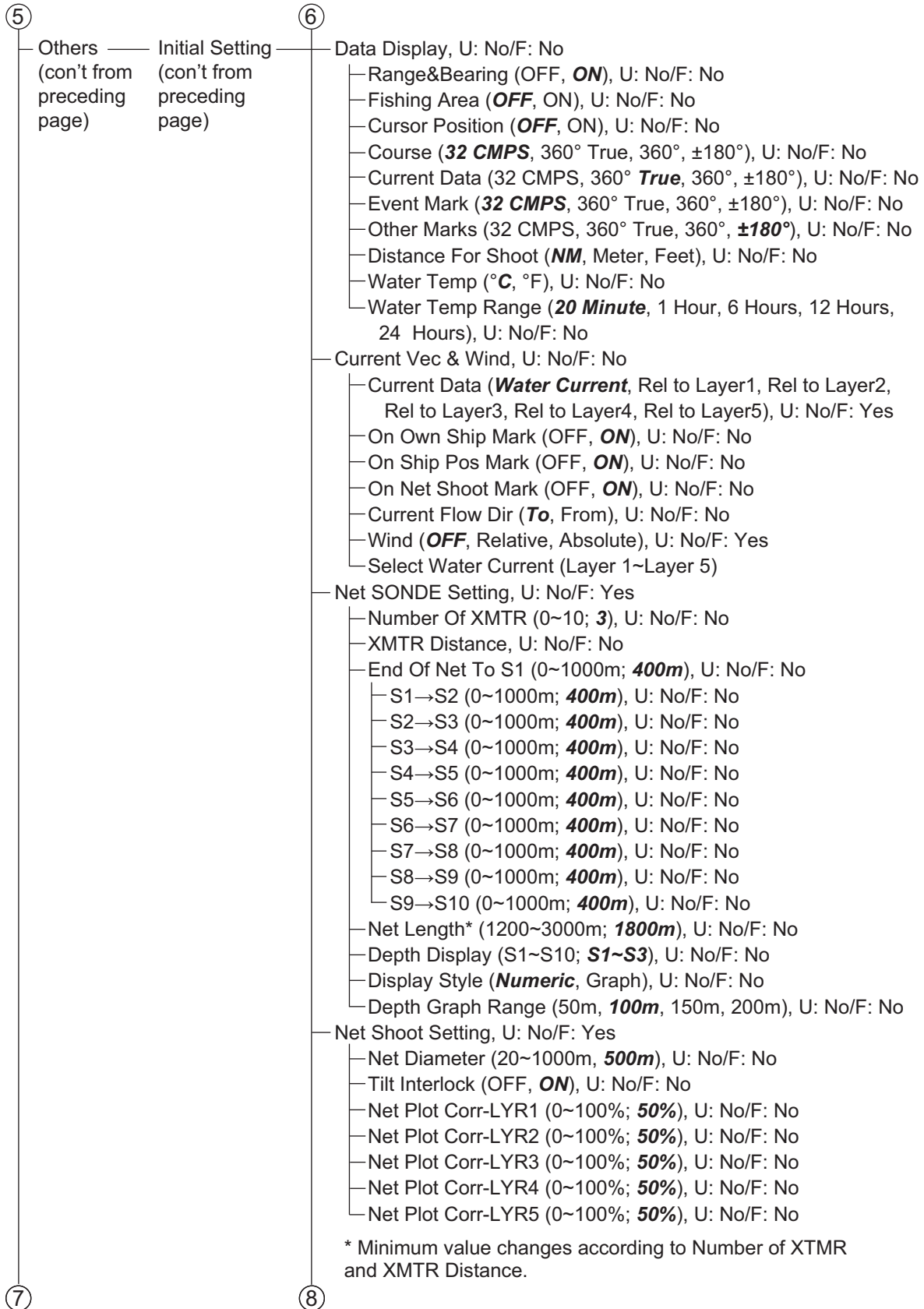

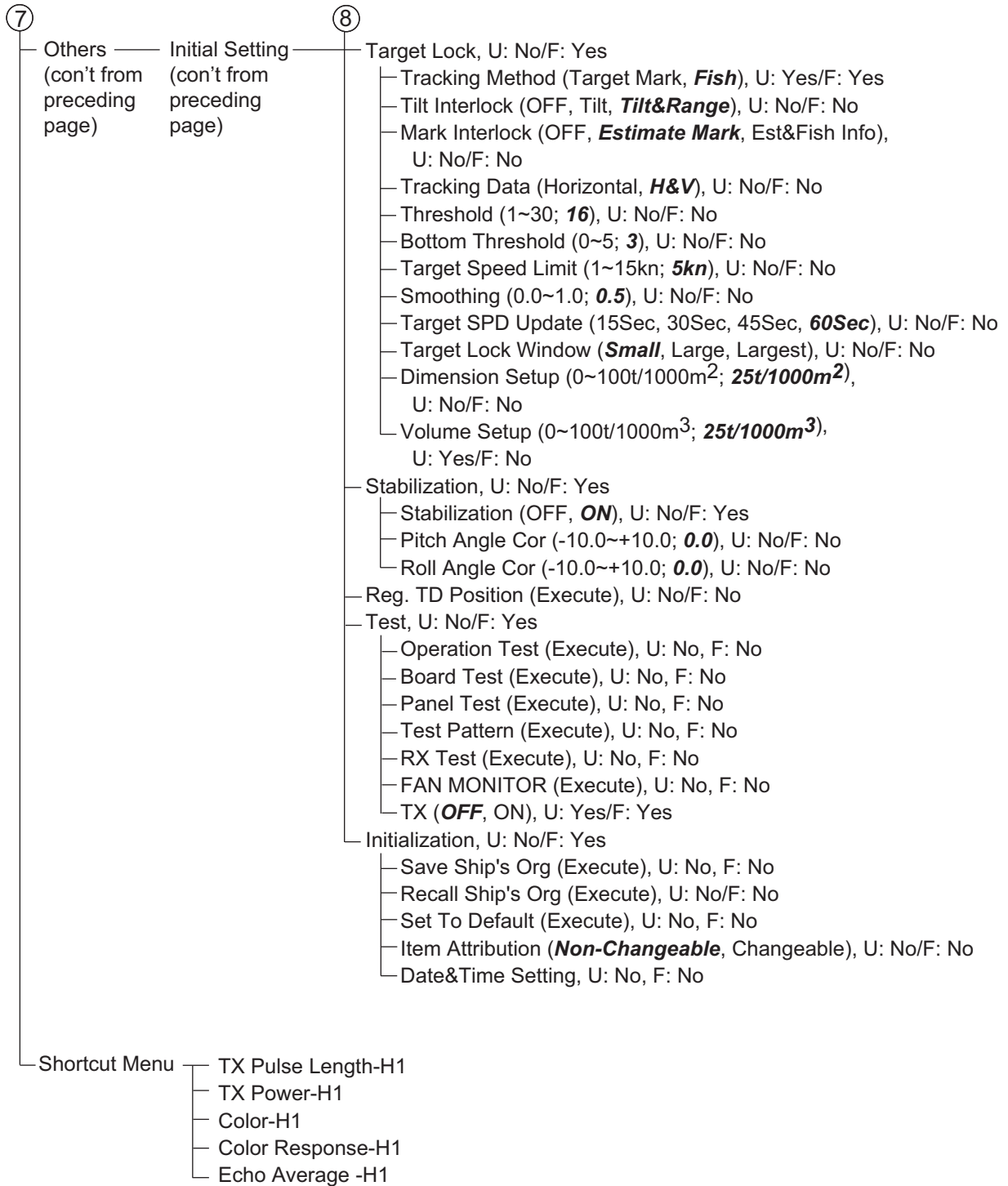

# APPENDIX 2 BRAKE CHECKING

Have a qualified technician check the brakes yearly.

## Brake Check Sheet for FSV-25 Hull Unit

Unit:  FSV-253  FSV-254

Serial no.: \_\_\_\_\_

Note:

- A. Follow the procedures for "How to Check the Brake in the Hull Unit" in Operator's Manual.
- B. While the Hull Unit is running, check the brake with care not to be caught up in the gear.
- C. Before doing the check, make sure no one is near the hull unit and transducer.

Check item	Date																
	Method, standard																
1. Checking the brake in the raise/lower control box																	
1-1. Set the toggle switch to the [BRAKE] side.	Check that the Brake LED on the circuit board is lit in red.	OK/NG	OK/NG	OK/NG	OK/NG	OK/NG	OK/NG	OK/NG	OK/NG	OK/NG	OK/NG	OK/NG	OK/NG	OK/NG	OK/NG	OK/NG	OK/NG
1-2. Set the toggle switch to the [BRAKE] position. Hold down the brake release push switch to release the motor brake.	Check that the main shaft does not lower and the 7-segment LEDs on the circuit board does not change.	OK/NG	OK/NG	OK/NG	OK/NG	OK/NG	OK/NG	OK/NG	OK/NG	OK/NG	OK/NG	OK/NG	OK/NG	OK/NG	OK/NG	OK/NG	OK/NG
1-3. Set the toggle switch to the [ABRAKE] side.	Check that the Brake LED on the circuit board is lit in red.	OK/NG	OK/NG	OK/NG	OK/NG	OK/NG	OK/NG	OK/NG	OK/NG	OK/NG	OK/NG	OK/NG	OK/NG	OK/NG	OK/NG	OK/NG	OK/NG
1-4. Set the toggle switch to the [ABRAKE] position. Hold down the brake release push switch to release the motor brake.	Check that the main shaft does not lower and the 7-segment LEDs on the circuit board does not change.	OK/NG	OK/NG	OK/NG	OK/NG	OK/NG	OK/NG	OK/NG	OK/NG	OK/NG	OK/NG	OK/NG	OK/NG	OK/NG	OK/NG	OK/NG	OK/NG
2. Measuring the gap in the motor brake																	
2-1. Insert the 0.7 mm leaf of the gap gauge.	Check that the 0.7 mm leaf can be inserted at three places.	OK/NG	OK/NG	OK/NG	OK/NG	OK/NG	OK/NG	OK/NG	OK/NG	OK/NG	OK/NG	OK/NG	OK/NG	OK/NG	OK/NG	OK/NG	OK/NG
2-2. If the check item 2-1 is NG, reduce the gap then check again.	Check that the 0.3 mm leaf can be inserted at three places.	OK/NG	OK/NG	OK/NG	OK/NG	OK/NG	OK/NG	OK/NG	OK/NG	OK/NG	OK/NG	OK/NG	OK/NG	OK/NG	OK/NG	OK/NG	OK/NG
	Check that the 0.4 mm leaf can not be inserted at three places.	OK/NG	OK/NG	OK/NG	OK/NG	OK/NG	OK/NG	OK/NG	OK/NG	OK/NG	OK/NG	OK/NG	OK/NG	OK/NG	OK/NG	OK/NG	OK/NG
3. Measuring the gap in the drive shaft gear																	
3-1. Insert the 0.6 mm leaf of the gap gauge.	Check that the 0.6 mm leaf can be inserted at three places.	OK/NG	OK/NG	OK/NG	OK/NG	OK/NG	OK/NG	OK/NG	OK/NG	OK/NG	OK/NG	OK/NG	OK/NG	OK/NG	OK/NG	OK/NG	OK/NG
3-2. If the check item 3-1 is NG, reduce the gap then check again.	Check that the 0.2 mm leaf can be inserted at three places.	OK/NG	OK/NG	OK/NG	OK/NG	OK/NG	OK/NG	OK/NG	OK/NG	OK/NG	OK/NG	OK/NG	OK/NG	OK/NG	OK/NG	OK/NG	OK/NG
	Check that the 0.3 mm leaf can not be inserted at three places.	OK/NG	OK/NG	OK/NG	OK/NG	OK/NG	OK/NG	OK/NG	OK/NG	OK/NG	OK/NG	OK/NG	OK/NG	OK/NG	OK/NG	OK/NG	OK/NG

**SPECIFICATIONS OF COLOR SCANNING SONAR  
FSV-25/25S**

**1 GENERAL**

1.1 Scanning method Full digital beam forming

1.2 Frequency 20 kHz

1.3 Range

FSV-25

Basic range (m)	Range (m)	
	Off-center 'OFF'	Off-center 'ON'
60	0-60	0-96
100	0-100	0-160
150	0-150	0-240
200	0-200	0-320
300	0-300	0-480
400	0-400	0-640
500	0-500	0-800
600	0-600	0-960
800	0-800	0-1280

Basic range (m)	Range (m)	
	Off-center 'OFF'	Off-center 'ON'
1000	0-1000	0-1600
1200	0-1200	0-1920
1600	0-1600	0-2560
2000	0-2000	0-3200
2500	0-2500	0-4000
3000	0-3000	0-4800
3500	0-3500	0-5000
4000	0-4000	0-5000
5000	0-5000	0-5000

FSV-25S

Basic range (m)	Range (m)	
	Off-center 'OFF'	Off-center 'ON'
60	0-60	0-96
100	0-100	0-160
150	0-150	0-240
200	0-200	0-320
300	0-300	0-480
400	0-400	0-640
500	0-500	0-800
600	0-600	0-960
800	0-800	0-1280
1000	0-1000	0-1600
1200	0-1200	0-1920
1600	0-1600	0-2560

Basic range (m)	Range (m)	
	Off-center 'OFF'	Off-center 'ON'
2000	0-2000	0-3200
2500	0-2500	0-4000
3000	0-3000	0-4800
3500	0-3500	0-5600
4000	0-4000	0-6400
5000	0-5000	0-8000
6000	0-6000	0-9600
7000	0-7000	0-10000
8000	0-8000	0-10000
9000	0-9000	0-10000
10000	0-10000	0-10000

1.4 Audio search 30°, 60°, 90°, 180°, 330° selectable

1.5 Audio output Audio terminal (requires speaker with amplifier)

**2 PROCESSOR UNIT**

2.1 Picture color 32 colors (sonar picture), 6 colors (marks)

2.2 Resolution 1280 x 1024 (SXGA), 1600 x 1200 (UXGA), 1920 x 1200 (WUXGA)

2.3 Orientation Head-up, North-up\*, Course up\* and True motion\*

\*: sensor required

- 2.4 Presentation mode Horizontal, Horizontal combination, Vertical 1 combination, Vertical 2 combination
- 2.5 Features Custom mode, Interference rejecter, After-glow, Noise limiter, Signal level, Auto-tilt, Automatic target tracking (target lock), Fish alarm, AGC, Reverberation suppression, Noise suppression, Transducer stop location control, Over-voltage warning, Unretracted transducer warning

### 3 TRANSCEIVER UNIT

- 3.1 Transmitter PDM half-bridge
- 3.2 Receiving method Straight amplifier, full digital beam forming
- 3.3 H-mode beam-width TX: 360° x 7°, RX: 12° x 10° (-3 dB full width)  
TX: 360° x 10°, RX: 16° x 14° (-6 dB full width)
- 3.4 V-mode beam-width TX: 360° x 29°, RX: 12° x 10° (-3 dB full width)  
TX: 360° x 47°, RX: 18° x 13° (-6 dB full width)
- 3.5 Tilt angle -5° to 60° (downward)
- 3.6 Vertical search range 0° to 60° (downward)

### 4 HULL UNIT

- 4.1 Raise/lower period (full projection)  
FSV-253 (1200 mm travel) 12 s  
FSV-254 (1600 mm travel) 16 s
- 4.2 Ship's speed allowance

Projection of transducer (mm)	Stable	Raise/lower operation
1100 or less	20 kn	14.5 kn
1100 to 1300	18 kn	13.5 kn
Over 1300	16 kn	12 kn

### 5 INTERFACE

- 5.1 Number of port
  - IEC61162-1/2 3 ports (NMEA0183 Ver1.5/2.0/3.0)
  - CIF 2 ports (input, current)
  - Contact signal 1 port (input, speed)
  - External KP Input: 1 port, Output: 3 ports, TTL level
- 5.2 I/O sentences
  - Input CUR, DBS, DBT, DPT, GGA, GLL, GNS, HDG, HDM, HDT, MDA, MTW, MWV, RMA, RMC, VBW\*<sup>1</sup>, VDR, VHW, VTG, VWR, VWT, ZDA
  - Output TLL

\*<sup>1</sup>: Fore-aft and port-stbd speeds required.
- 5.3 Output proprietary sentences
  - PFEC evt, fkv, fmg, fvc, pidat, sht, tfm, tlm, tqm
- 5.4 CIF sentences
  - System clock, Position, Bearing, First layer current data, Water depth, Water temperature, Sonde depth, Ship's speed/course data, Multi-layer current data, Net depth, Wind speed/direction, Sonde number

**6 POWER SUPPLY**

- 6.1 Processor unit 12-24 VDC: 10-5 A, includes I/F unit (48VDC)
- 6.2 Power supply unit 100/110/115/220/230 VAC: 14 A max, 1 phase, 50/60 Hz  
Output for transceiver unit: 200 VAC, 1 phase, 50/60 Hz
- 6.3 Raise/lower control box 200-220 VAC: 16 A max, 3 phase, 50/60 Hz
- 6.4 Rectifier (option)  
RU-1746B-2 100/110/115/220/230 VAC, 1 phase, 50/60 Hz
- 6.5 AC/DC power supply unit (option)  
PR-241 100-230 VAC, 1 phase, 50-60 Hz

**7 ENVIRONMENTAL CONDITIONS**

- 7.1 Ambient temperature
  - Processor unit 0°C to +45°C
  - Transducer -5°C to +35°C
  - Others 0°C to +50°C
- 7.2 Relative humidity 93% or less at +40°C
- 7.3 Degree of protection
  - Control unit IP22 (panel), IP20 (chassis)
  - Processor unit/ Interface unit/ Remote control unit IP20
  - Transceiver unit/ Power supply unit/ Junction box IP22
  - Hull unit IPX2
  - Transducer IPX8
- 7.4 Vibration IEC 60945 Ed.4

**8 UNIT COLOR**

- 8.1 Processor unit/ Control unit/ Interface unit/ Transceiver unit/ Power supply unit N2.5
- 8.2 Hull unit/ Raise lower control box/ Control box extension box/ Junction box 2.5G7/2

# INDEX

---

## A

- AGC
  - horizontal display .....2-11
  - vertical display.....3-8
- Alarm & Audio menu .....6-5
- Aural detection of school of fish
  - automatic training.....2-24
  - bearing setting.....2-22
  - reverberation setting .....2-24
  - sector setting.....2-23
- AUTO TRAIN key..... 2-24, 3-5

## B

- Beam width
  - horizontal display .....2-17
  - vertical display.....3-12
- Bearing measurement
  - vertical display.....3-6
- Bearing scale .....6-9
- Board test.....8-13
- Brake check sheet .....AP-6
- BRILLIANCE control ..... 1-8

## C

- Color
  - color arrangement, horizontal display ....2-36
  - color arrangement, vertical display .....3-13
  - color response, horizontal display .....2-36
  - color response, vertical display .....3-13
  - color setting, horizontal display .....2-37
  - color setting, vertical display .....3-13
- Concentration of school of fish.....2-27
- Control description ..... 1-1
- Current Vec & Wind menu .....6-13

## D

- Data Box menu .....6-8
- Data display
  - description.....4-2
  - full.....4-1
- Data on track.....6-10
- DELETE MARK key ..... 2-31, 2-33
- Display Setting menu .....6-3
  - horizontal display .....2-36
  - vertical display.....3-13

## E

- Echo average
  - horizontal display .....2-17
  - vertical display.....3-12
- Erase Marks menu ..... 2-31, 6-1
- Error codes .....8-10
- ESTIMATE keys.....2-27
- EVENT key .....2-32
- Event mark
  - deleting.....2-33

- entering .....2-32

## F

- Fan motor test .....8-15
- Fish alarm
  - alarm level ..... 2-26, 6-5
  - setting.....2-24
- FISH key .....2-30
- Fish marks
  - connecting .....6-10
  - deleting.....2-31
  - entering .....2-30
  - measuring speed with .....2-30
- Frequency shift
  - horizontal display .....2-15
  - vertical display.....3-10
- Function keys
  - erasing programs ..... 5-4, 5-5
  - executing .....5-3
  - programming .....5-3
- Fuse replacement .....8-5

## G

- Gain (near, far)
  - horizontal display .....2-10
  - vertical display.....3-8
- GAIN control .....1-13

## H

- Heading mark.....6-9
- Horizontal mode
  - full-screen display .....2-2
  - horizontal2 mode.....2-3
- Hull unit maintenance.....8-2

## I

- Initial Setting menu .....6-7
- Initialization menu .....6-16
- Interference rejector
  - horizontal display ..... 2-15, 3-10

## K

- Key beep volume .....6-4

## M

- Maintenance
  - general .....8-1
  - hull unit.....8-2
- Mark Display menu .....6-9
- Mark Size menu .....6-11
- Memory card
  - deleting files from .....7-2
  - formatting .....7-4
  - loading files from .....7-2
  - saving picture to .....7-1
- Menu operation .....1-14
- Mode selection method .....6-3



- Monitor Setting menu ..... 6-8
- N**
- Net course mark ..... 2-34
- Net movement plot ..... 6-10
- Net Shoot Setting menu ..... 6-15
- Net SONDE Setting menu ..... 6-14
- Noise limiter
  - horizontal display ..... 2-16
  - vertical display ..... 3-11
- Noise suppression
  - horizontal display ..... 2-12
  - vertical display ..... 3-9
- O**
- Off center ..... 2-27
- OFF CENTER key ..... 2-27
- Operation test ..... 8-12
- Others menu
  - description ..... 6-1
- Own ship position mark ..... 2-33
- P**
- Panel dimmer ..... 1-8
- Panel test ..... 8-14
- Picture Setting menu
  - horizontal display ..... 2-39
  - vertical display ..... 3-14
- Power switches ..... 1-5
- Presentation mode ..... 2-21
- R**
- R/B AUDIO key ..... 2-22
- Range
  - horizontal mode ..... 2-4
  - vertical display ..... 3-6
- Range and bearing measurement
  - horizontal display ..... 2-8
  - vertical display ..... 3-6
- RANGE control ..... 2-4, 3-6
- Range rings ..... 6-9
- Register menu ..... 6-6
- Reverberation
  - horizontal display ..... 2-17
  - vertical display ..... 3-12
- S**
- Ship's track ..... 6-9
- SHOOT key ..... 2-35
- Signal level
  - horizontal display ..... 2-36
  - vertical display ..... 3-13
- Smoothing
  - horizontal display ..... 2-39
  - vertical display ..... 3-14
- Stabilization menu ..... 6-15
- Status messages ..... 8-10
- T**
- Target lock
  - dimensions ..... 2-21
  - fish mode ..... 2-19
  - fish track plot ..... 6-10
  - mark interlock ..... 2-20
  - mode selection ..... 2-18
  - smoothing ..... 2-20
  - target lock window ..... 2-20
  - target mark mode ..... 2-20
  - target speed limit ..... 2-20
  - target speed update ..... 2-20
  - threshold ..... 2-20
  - tilt interlock ..... 2-20
  - tracking data ..... 2-20
  - volume setup ..... 2-21
- TARGET LOCK key ..... 2-19
- Target Lock menu ..... 2-20
- Test menu ..... 8-11
- Test pattern ..... 8-15
- Tilt angle
  - automatic ..... 2-5
  - setting ..... 2-4
- TILT control function ..... 6-4
- Tilt mark ..... 3-4
- Trackball mark position reference mark ..... 3-5
- Transducer
  - automatic raising from hull unit ..... 8-16
  - lowering ..... 1-6
  - manual raising from hull unit ..... 8-18
  - raising ..... 1-6
- Transducer position mark ..... 1-7
- Troubleshooting ..... 8-7
- True motion display range ..... 6-4
- TX interval ..... 2-14
- TX power ..... 2-13
- TX pulse length
  - horizontal display ..... 2-12
  - vertical display ..... 3-9
- U**
- User menu
  - deleting items from ..... 5-1
  - programming ..... 5-1
- USER PROG control
  - program selection ..... 5-7
  - programming ..... 5-7
- V**
- Vertical bearing mark ..... 3-4
- W**
- Warning messages ..... 8-8

## EC Declaration of Conformity



We **FURUNO ELECTRIC CO., LTD.**

(Manufacturer)

9-52 Ashihara-Cho, Nishinomiya City, 662-8580, Hyogo, Japan

(Address)

declare under our sole responsibility that the product

**COLOR SCANNING SONAR FSV-25, FSV-25S, FSV-28W and FSV-28WL**

(Model name, type number)

to which this declaration relates is in conformity with the following standard(s) or other normative document(s)

IEC 60945 Ed.4.0: 2002, clauses 9.2, 9.3, 10.3, 10.4, 10.5, 10.8 and 10.9 incl. Corr. 1: 2008  
IEC 60945 Ed.3.0: 1996, clauses 10.2 and 10.3

(title and/or number and date of issue of the standard(s) or other normative document(s))

For assessment, see

- EMC Test Report FLI 12-13-156, March 12, 2014 prepared by Furuno Labotech International Co., Ltd.

This declaration is issued according to the Directive 2014/30/EU of the European Parliament and of the Council of 26 February 2014 on the harmonisation of the laws of the Member States relating to electromagnetic compatibility.

On behalf of Furuno Electric Co., Ltd.

Nishinomiya City, Japan  
April 20, 2016

(Place and date of issue)

Yoshitaka Shogaki  
Department General Manager  
Quality Assurance Department

(name and signature or equivalent marking of authorized person)