

# **OPERATOR'S MANUAL**

*FURUNO FINLAND OIL RADAR  
FOIL-200*

## Contents

FOREWORD.....	4
A Word to the Owner of the Furuno Finland Oil Radar FOIL-200.....	4
Features .....	4
Software history .....	4
1. SYSTEM CONFIGURATION .....	5
2. GRAPHICAL USER INTERFACE (GUI) .....	6
2.1 Operating mode selections .....	7
2.2 Navigational data .....	7
2.3 Oil filter parameter adjustments.....	8
2.4 Cursor position indicator.....	8
2.5 Local time .....	9
2.6 Oil detected alert indication box .....	9
2.7 EBL/VRM.....	10
2.8 Display mode selections.....	10
3. USE OF FUSION SCANS AND MODES.....	11
3.1 Adjusting Fusion Scans.....	11
3.2. Fusion Modes.....	11
3.2.1 Use of Fusion mode .....	12
4. OIL DETECTION.....	13
4.1 How to activate oil layer .....	13
4.2 How to adjust oil layer .....	13
4.3 How to activate automatic oil detection.....	13
4.4 How to choose alert category for automatic oil detection .....	14
4.4.1 Alert output .....	14
4.5 How to adjust sensitivity of automatic oil detection.....	14
4.6 How to display automatically detected area information.....	15
5. RAW RADAR VIDEO .....	16
5.1 How to adjust raw radar video .....	16
6. SCREEN SHOTS.....	17
6.1 How to take screenshots.....	17
6.2 How to export screenshots .....	17
6.3 How to delete screenshots.....	18
7. MANUALLY MARKED AREAS.....	19
7.1 How to Show or Hide marked area on display .....	19
7.2 How to add new area.....	19
7.3 How to Modify area .....	20

7.4 How delete area(s) .....20

8. OTHER FUNCTIONS.....21

8.1 How to change time zone.....21

8.2 Shut down or restart of FOIL-200 Oil radar .....21

8.3 How to upgrade software .....21

# **FOREWORD**

## **A Word to the Owner of the Furuno Finland Oil Radar FOIL-200**

Congratulations on your choice of the FURUNO FINLAND Oil Radar FOIL-200.

Your equipment is designed and constructed to meet the rigorous demands of the marine environment. However, no machine can perform its intended function unless properly operated and maintained. Please carefully read and follow the operation and maintenance procedures set forth in this manual.

Thank you for considering and purchasing FURUNO FINLAND.

We would appreciate feedback from you, the end-user, about whether we are achieving our purposes.

### **Features**

The Furuno Finland Oil Radar is hybrid ice radar. It is based on the normal Furuno ARPA radar, and captures a copy of the raw radar signal from the ARPA processor. The normal operation of the ARPA radar is not affected.

The Oil Radar is not a navigational device. It is a supplementary system for the specific task of observing oil slicks by radar.

If you like to know more about the Oil Radar capabilities please contact to Furuno Finland Oy ([www.furuno.fi](http://www.furuno.fi)).

### **Software history**

V1.00 Initial Release

V1.10 New release, 01 Feb 2015

V2.00 New hardware

# 1. SYSTEM CONFIGURATION

Interconnection diagram

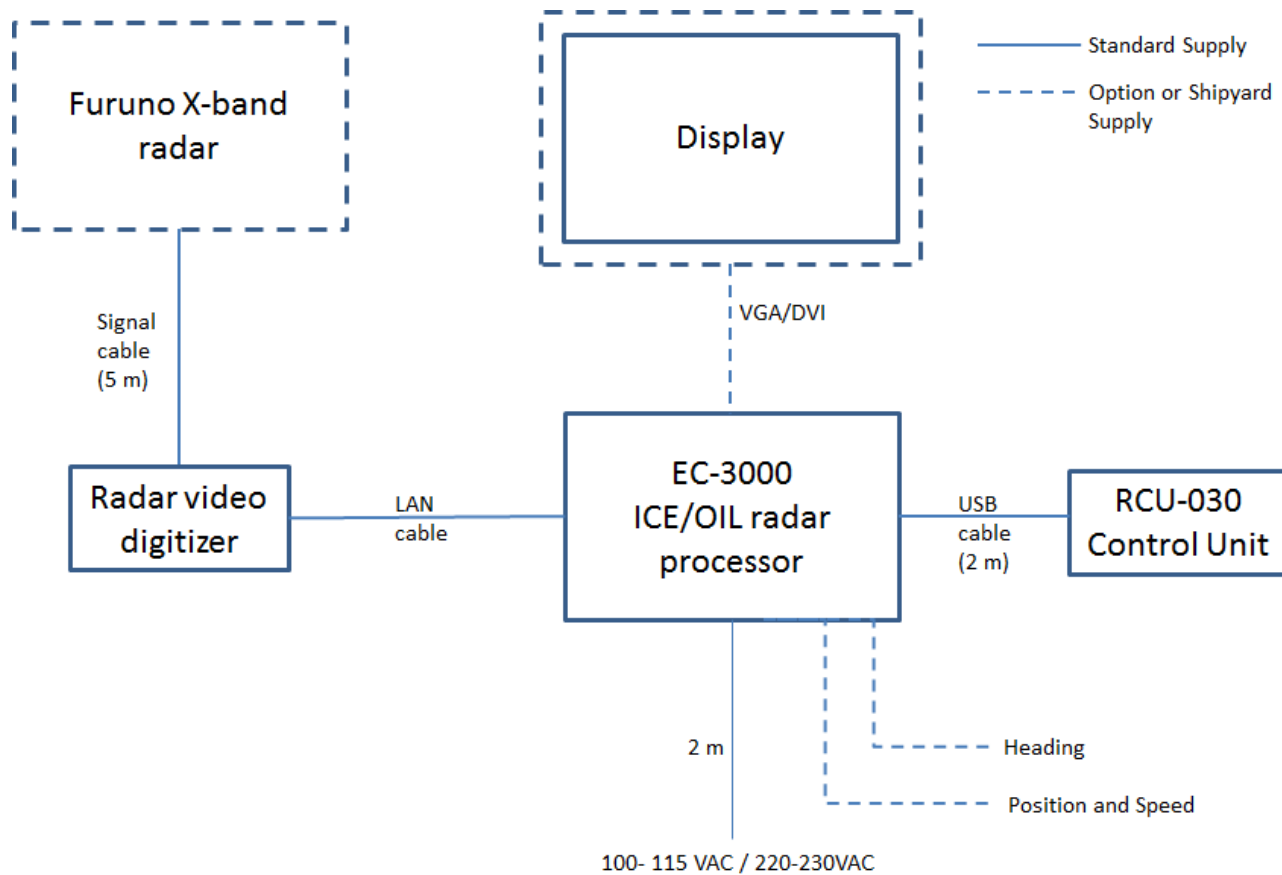

## 2. GRAPHICAL USER INTERFACE (GUI)

The Oil Radar graphical user interface (GUI) is based on a single screen.

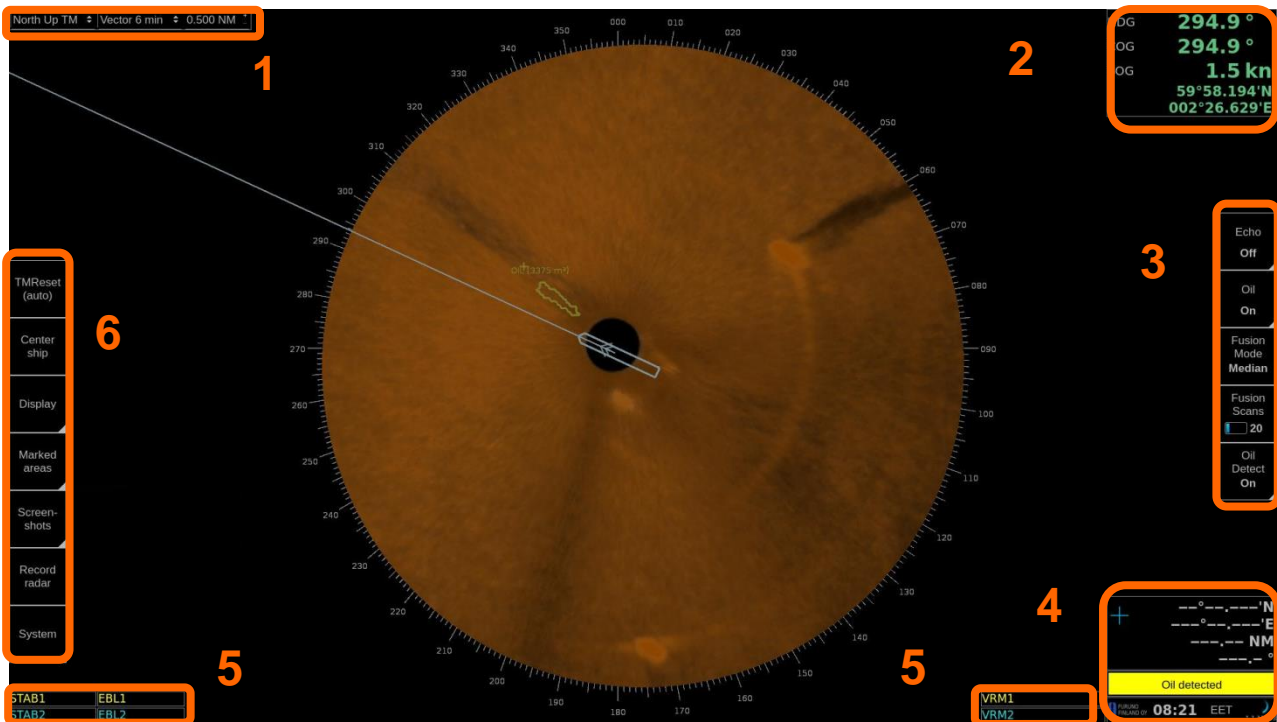

### User interface sections

1.	Motion mode, vector time selection and range/scale selection
2.	Navigational data (Note, if speed log connected, SPD is available in this field)
3.	Oil filter parameter adjustment
4.	Cursor position indicator. Alerts when oil is detected.
5.	EBL/VRM indicators
6	TM reset, Center ship, Display palette selection, Marked area, Screenshots and Record radar buttons (Record radar is optional function)

## 2.1 Operating mode selections

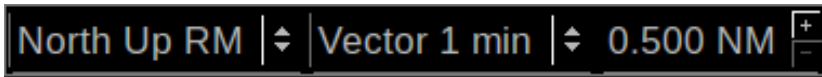

No.	Description
1.	Motion mode select - Available modes: <ul style="list-style-type: none"> <li>- Head Up TM</li> <li>- Head Up RM</li> <li>- North Up TM</li> <li>- North Up RM</li> </ul>
2.	Vector – Selection of vector length (Off, 1 min, 3 min, 6 min)
3.	Range/Scale indicator – Shows the range used in Oil Radar display.

## 2.2 Navigational data

The indicators are passive repeaters of navigational data received from the sensors.

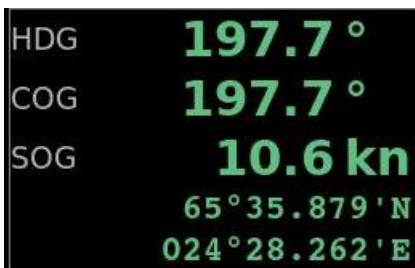

No.	Description
1.	HDG; Heading
2.	SPD; Speed through water (is shown only if source of SPD connected to radar)
3.	COG; Course over ground
4.	SOG; Speed over ground
5.	Position (Lat, Lon)

## 2.3 Oil filter parameter adjustments

These parameters affect the behavior of the oil filter.

	Description
Echo <b>Off</b>	Echo – toggle navigational radar echoes on/off. Treshold – adjust threshold for echoes Brightness – adjust brightness of navigational radar echoes
Oil <b>On</b>	Oil – toggle oil echoes on/off. Hue – choose color of oil layer Brightness – adjust brightness of oil layer. Contrast – adjust contrast of oil layer. Gamma – adjust linearity of oil color.
Fusion Mode <b>Median</b>	Fusion Mode: Off Median Minimum Adaptive For more information, see chapter 3.2.
Fusion Scans <input type="checkbox"/> 22	Adjust number of scans – how many overlapping radar scans are used for the oil echoes Note, if Fusion mode is “Off”, Fusion scans is not in use. Note, if Oil detection is “On”, Fusion mode “Off”, number of Fusion Scans is set automatically to 20.
Oil Detect <b>On</b>	Oil Detect – Toggle automatic oil detection on/off. For more information, see chapter 4.

## 2.4 Cursor position indicator

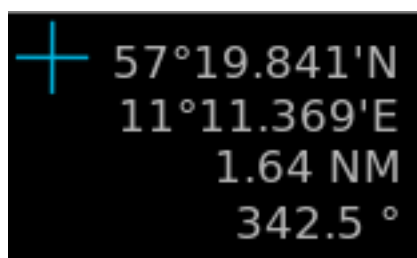

No.	Description
1.	Cursor position display (LAT, LON) and range and bearing from own ship position



## 2.5 Local time



To change between local time and UTC, move cursor over time zone indication and click left mouse button to toggle between local time zone and UTC.

Note, time adjustment is using ZDA sentence received from EPFS device.

To change time zone, see also chapter “8.1. How to change time zone”.

## 2.6 Oil detected alert indication box

Between cursor position and local time boxes there is box for Alerts. See below:



For more information about external alert unit, see chapter “4.4. How to choose alert category for automatic oil detection”

If external alert unit is connected to FOIL-200, you can reset alarm by moving cursor over alarm box and press left mouse key.

## 2.7 EBL/VRM

There are two EBL/VRM measurement tools available. You can choose the operating modes of these tools by clicking in the STAB1 or STAB2 box with your mouse.

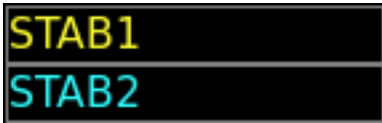

No.	Description
1.	Blank – tool is disabled
2.	Ship – the measurements are done from the ship's conning position
3.	Gnd – the measurements are stabilized to ground

The EBL and VRM values are shown both on screen and in the respective boxes.



No.	Description
1.	Click on EBL1 or EBL2 will toggle the EBL between true (T) and relative (R) measurements
2.	Click on VRM1 or VRM2 will show or hide the VRM measurement
3.	Using the scroll wheel on any box will adjust that value.

EBL/VRM can be adjusted by dragging the intersection point on the screen.

Note: you choose the point to drag by clicking on the first point with the right mouse button. To release the drag you have to click with the right mouse button again after moving the point to the new position.

## 2.8 Display mode selections



No.	Description
1.	Click on <b>TMReset</b> to reset vessel position to reset margin.
2.	Click on <b>Center ship</b> to place vessel on the center of screen.
3.	Use <b>Display</b> to select Day or Night palette.

# 3. USE OF FUSION SCANS AND MODES

The surrounding weather condition and sea state and of course the installation height of the radar antenna effects on the image processing on Oil radar. Use shortest pulse as possible on navigation radar. Pulse length depends on selected range. If the pulse is too long, the Oil Radar image will be granular.

Oil radar FOIL-200 has several options for Fusion modes together with number of scans to process video image on screen. You can change between different Fusion modes and see the result on real time on the screen. This is the best way to achieve the most efficient image to detect oil. Fusion scans are motion compensated.

You can also tune brightness, contrast and gamma. These controls affect the clarity of the image.

Below you will find instructions on how to adjust Fusion Scans, descriptions of the Fusion Modes and some examples on how to use them.

## 3.1 Adjusting Fusion Scans

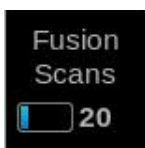

No.	Description
1.	You can adjust Fusion Scans by moving the cursor over Fusion Scans and selecting the number of Scans by scrolling the mouse wheel.

## 3.2. Fusion Modes



Fusion modes can be changed by moving the mouse cursor over Fusion Modes and selecting the mode with scrolling the mouse wheel. Below you will find explanations for each Fusion Mode.

Mode	Description
<b>Off</b>	Fusion mode is disabled.  This mode can be used if you want to get normal radar video image without oil information.
<b>Median</b>	This mode is used to remove temporary noise. The edges of echoes are displayed. Note that moving echoes (objects) will be lost.
<b>Minimum</b>	This mode uses weak echoes.  This mode can be used if you need to display very weak oil signals.
<b>Adaptive</b>	Adaptive mode is like a median filter, but with this mode weak echoes of moving objects can be shown.  This mode can be used when you need to combine the properties of Median and Off modes.

### 3.2.1 Use of Fusion mode

FOIL-200 supports many filtering and image parameters that can be adjusted to find the optimal visual representation. Most parameter changes take visible effect immediately and hence facilitate convenient real-time adjustments to adapt the image into current weather conditions.

Below is shown how oil slick is shown on radar when using fusion mode Adapt.

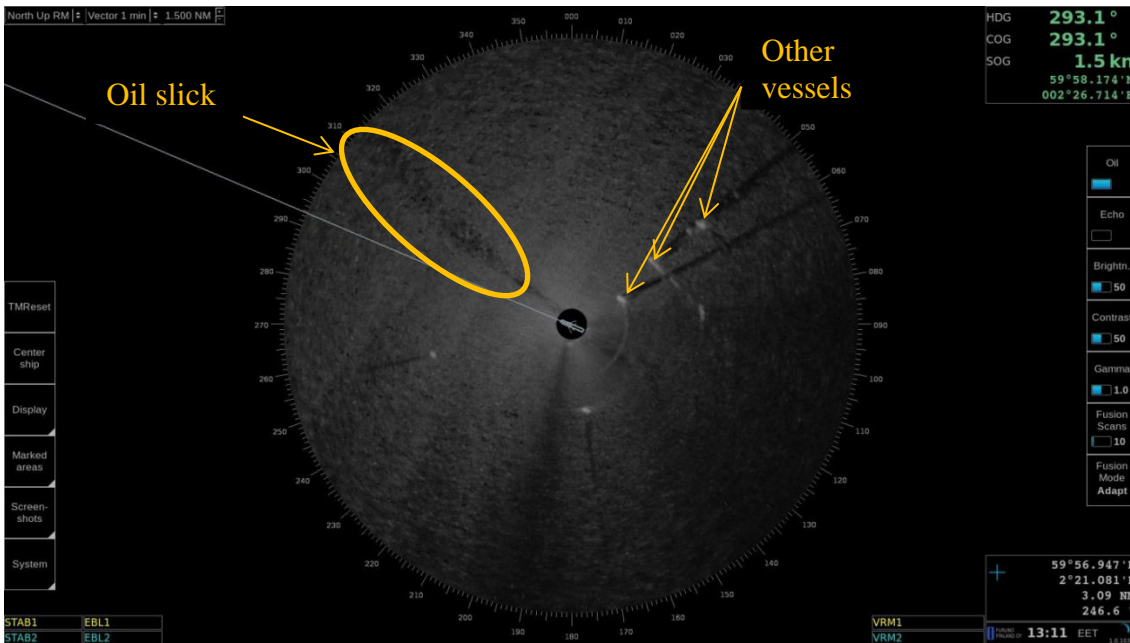

Examples for different Fusion modes

1. Unfiltered image

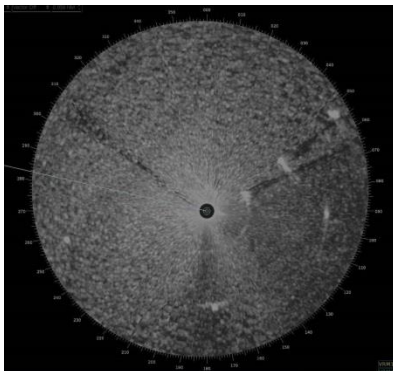

2. Median intensity over last 25 scans, low gamma, high contrast and brightness.

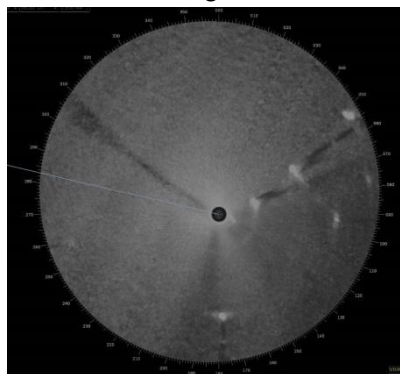

3. Minimum intensity over last 25 scans, low gamma and brightness, high contrast.

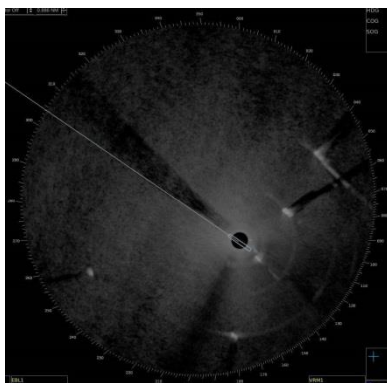

# 4. OIL DETECTION

---

Oil detection can be done manually or automatically.

## 4.1 How to activate oil layer

Move cursor over Oil button and scroll the mouse wheel to switch between Off/On.



## 4.2 How to adjust oil layer

Click Oil detect button to open Oil detect menu.



	Description
Hue	choose color of oil layer
Gamma	adjust linearity of oil color
Contrast	adjust contrast of oil layer
Brightness	adjust brightness of oil layer

## 4.3 How to activate automatic oil detection

Oil radar FOIL-200 can automatically detect oil slick based on selected filter mode. Move cursor over Oil Detect button and scroll the mouse wheel to switch between Off/On.



## 4.4 How to choose alert category for automatic oil detection

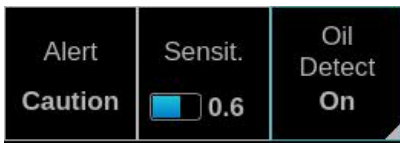

You can select if detected oil slick alert category is warning or caution.



Unacknowledged alert is indicated as yellow background flashing and when alert is acknowledged yellow background stops flashing.

If **caution** is selected automatically detected oil slick is indicated as yellow color in alert box and area is shown on radar display in yellow color.

If **warning** is selected automatically detected oil slick is indicated as yellowish color box and area is shown on radar display in yellow color.

### 4.4.1 Alert output

If automatic oil detection is selected as warning it is possible to get relay output from USB –port (owner supply relay and buzzer). When alert is unacknowledged relay output is activated.

## 4.5 How to adjust sensitivity of automatic oil detection

Adjust value of sensitivity to find oil slick(s) scroll the mouse wheel on Sensit. box.



Setting of Sensitivity is highly depending on environmental conditions (wave height, wind, etc.) and raw radar video quality. High value of sensitivity may cause misinterpretation of image and lead sometimes to incorrect indication of oil slick area.

## 4.6 How to display automatically detected area information

Move cursor over the cross located in center point of automatically detected oil area and click right mouse button. Text "Info" appears on screen, click it to open a window to the right hand side of the screen.



Select Info and following window appears to the right hand side of the screen:

▶▶ Oil Area	
Latitude	59°58.334'N
Longitude	002°26.279'E
Area	3237.5 m <sup>2</sup>

You can view LAT/LON of center point and size of detected area.  
To close this window click >> button on the upper left corner of window.

# 5. RAW RADAR VIDEO

---

## 5.1 How to adjust raw radar video

Oil radar FOIL-200 receives raw radar video from navigational radar. Raw radar video can be adjusted on FOIL-200 using threshold and Brightness buttons.



	Description
<b>Thresh.</b>	Use Threshold button to emphasize raw radar video levels. The higher value of Threshold is the higher level of raw radar video is displayed.
<b>Brightn.</b>	Use Brightness to adjust brightness of raw video on FOIL-200.



# 6. SCREEN SHOTS

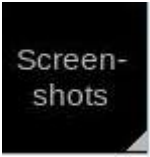

No.	Description
1	Click on Screenshots to capture single or multiple screenshots covering the whole display.

Screenshots –function allows you to capture single or multiple screenshots of the whole display in JPEG - format. These screenshots can be also exported to an external memory, such as an USB stick.

Screenshots –function is operated by clicking Screenshots with your mouse and selecting Take, Export or Delete all.

## 6.1 How to take screenshots

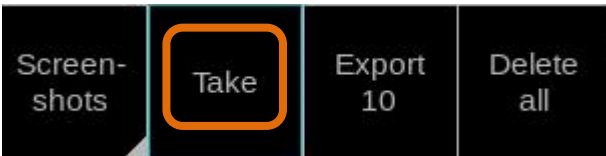

No.	Description
1.	Click on Screenshots to open the screenshots menu
2.	Click on Take to capture single or multiple screenshots. You can see the number of taken screenshots in the Export –box.

## 6.2 How to export screenshots

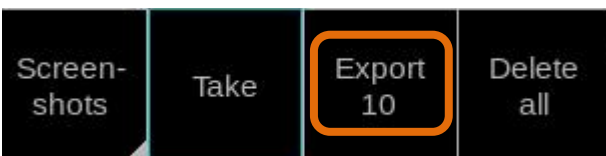

No.	Description
1.	Click on Screenshots to open the screenshots menu
2.	Click on Export to move the captured screenshots to an external memory, such as an USB stick.  You can export the screenshots by following these steps: <ol style="list-style-type: none"> <li>1. Connect the external memory to your workstation</li> <li>2. Click Screenshots and Export</li> <li>3. The screenshots have been successfully moved to an external memory, when the number under Export goes back to zero.</li> <li>4. On your external memory the screenshots can be found in folder “\exports\screenshots\”. The filenames of screenshots indicate the date and time of capture e.g. “20140221T111738025UTC.jpg”</li> </ol>

Note: Clicking Export moves the screenshots to an external memory and removes them from your workstation.

### 6.3 How to delete screenshots



No.	Description
1.	Click on Screenshots to open the screenshots menu
2.	Click on Delete all to delete all captured screenshots.  If Delete all is selected, "Are you sure?" dialogue appears, and has to be clicked again for confirmation. After Deleting all, the number under Export will return to zero.

# 7. MANUALLY MARKED AREAS



No.	Description
1.	Click on Marked areas to create area to mark place of oil spill on Oil radar.

Marked areas –function is operated by clicking Marked areas with your mouse and selecting Show/Hide, Add, Edit, Delete or Delete all.



## 7.1 How to Show or Hide marked area on display

You can toggle areas ON/OFF on oil radar as you requested. When area is selected to be displayed the color of the button is blue as shown below.



No.	Description
1.	Click on Marked areas to open the screenshots menu
2.	Click on Show/Hide to have areas to shown or not shown on display

## 7.2 How to add new area

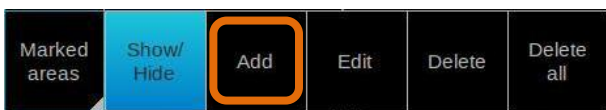

Note: Clicking Export moves the screenshots to an external memory and removes them from your workstation.

No.	Description
1.	Click on Marked areas to open the screenshots menu
2.	Click on Add to make new area on display
3.	Use cursor to point location of corner point, use left button of mouse to fix location of corner point
4.	When modifying is completed, click on Marked areas again, and click OK to confirm modified area.
5.	Area is named with date and time stamp (UTC) and color of area is turned to green.

### 7.3 How to Modify area

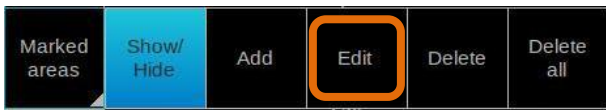

No.	Description
1.	Click on Marked areas to open the screenshots menu
2.	Click on Edit to make new area on display
3	Use cursor to point area to be modified, use left button of mouse to select area. Color of Selected (modified) area is yellow. You can drag and drop corner points or add new corner points to area.
4	When modifying is completed, click on Marked areas again, and click OK to confirm modified area.
5	Area is named with date and time stamp (UTC) and color of area is turned to green.

### 7.4 How delete area(s)



No.	Description
1.	Click on Marked areas to open the screenshots menu
2.	Click on Delete or Delete all to delete areas stored on radar. <ul style="list-style-type: none"><li>- Delete is used to remove selected (yellow) area on radar</li><li>- Delete all is used to remove all areas on radar</li></ul>
3	Click on Delete to delete selected area: <ul style="list-style-type: none"><li>- Use cursor to point area to be deleted, use left button of mouse to select area. Color of Selected area is yellow. Click Marked areas again, and click OK to confirm modified area.</li></ul>
4	Click on Delete all to delete all captured screenshots. <ul style="list-style-type: none"><li>- If Delete all is selected, "Are you sure?" dialogue appears, and has to be clicked again for confirmation.</li></ul>

# 8. OTHER FUNCTIONS

---

## 8.1 How to change time zone



No.	Description
1.	Click on System to select time zone.
2.	Select the required time zone in the drop-down menu.

## 8.2 Shut down or restart of FOIL-200 Oil radar



No.	Description
1.	Click on System to open menu.
2.	Select "Shut down" to close the FOIL-200 processor or "Reboot" close and start FOIL-200 processor.

## 8.3 How to upgrade software

If you receive new software package from manufacturer (normally stored on USB memory stick), you can load software package to FOIL-200 easily.



No.	Description
1.	Connect USB memory stick to upgrade new software for FOIL-200.
2.	Click on System to open the System menu.
3.	Choose Upgrade sw.
4.	Follow instructions displayed during software upgrade.