

FURUNO

OPERATOR'S MANUAL

Stabilized FISH SIZE INDICATOR

Model **FCV-38**

(Product Name: FISH FINDER)

 FURUNO ELECTRIC CO., LTD.



www.furuno.com

Attach Transducer Data Sheet here.

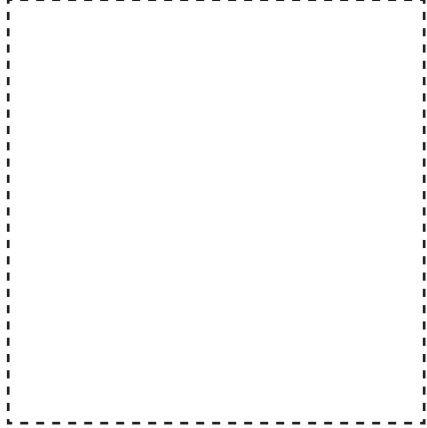

FURUNO ELECTRIC CO., LTD.

9-52, Ashihara-cho,
Nishinomiya, 662-8580, JAPAN

·FURUNO Authorized Distributor/Dealer

All rights reserved. Printed in Japan

A : SEP. 2020
B1 : JAN. 6, 2023

Pub. No. OME-23920-B1
(GREG) FCV-38



00019701311

IMPORTANT NOTICES

General

- This manual has been authored with simplified grammar, to meet the needs of international users.
- The operator of this equipment must read and follow the instructions in this manual. Wrong operation or maintenance can void the warranty or cause injury.
- Do not copy any part of this manual without written permission from FURUNO.
- If this manual is lost or worn, contact your dealer about replacement.
- The contents of this manual and the equipment specifications can change without notice.
- The example screens (or illustrations) shown in this manual can be different from the screens you see on your display. The screens you see depend on your system configuration and equipment settings.
- Save this manual for future reference.
- Any modification of the equipment (including software) by persons not authorized by FURUNO will void the warranty.
- The following concern acts as our importer in Europe, as defined in DECISION No 768/2008/EC.
 - Name: FURUNO EUROPE B.V.
 - Address: Siriusstraat 86, 5015 BT, Tilburg, The Netherlands
- The following concern acts as our importer in UK, as defined in SI2016/1025 as amended SI2019/470.
 - Name: FURUNO (UK) LTD.
 - Address: West Building Penner Road Havant Hampshire PO9 1QY, U.K.
- InstantAccess bar is a trademark of FURUNO Electric Co., Ltd.
- All brand, product names, trademarks, registered trademarks, and service marks belong to their respective holders.

How to discard this product

Discard this product according to local regulations for the disposal of industrial waste. For disposal in the USA, see the homepage of the Electronics Industries Alliance (<http://www.eiae.org/>) for the correct method of disposal.

How to discard a used battery

Some FURUNO products have a battery(ies). To see if your product has a battery, see the chapter on Maintenance. If a battery is used, tape the + and - terminals of the battery before disposal to prevent fire, heat generation caused by short circuit.

In the European Union

The crossed-out trash can symbol indicates that all types of batteries must not be discarded in standard trash, or at a trash site. Take the used batteries to a battery collection site according to your national legislation and the Batteries Directive 2006/66/EU.

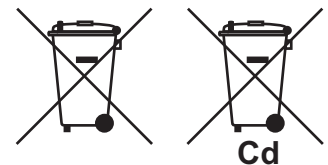

In the USA

The Mobius loop symbol (three chasing arrows) indicates that Ni-Cd and lead-acid rechargeable batteries must be recycled. Take the used batteries to a battery collection site according to local laws.

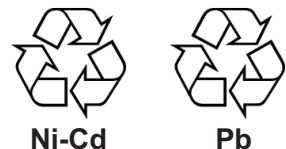

In the other countries

There are no international standards for the battery recycle symbol. The number of symbols can increase when the other countries make their own recycle symbols in the future.



SAFETY INSTRUCTIONS

The operator must read the applicable safety instructions before attempting to operate the equipment.



WARNING

Indicates a potentially hazardous situation which, if not avoided, could result in death or serious injury.



CAUTION

Indicates a potentially hazardous situation which, if not avoided, can result in minor or moderate injury.



Warning, Caution



Prohibitive Action



Mandatory Action



WARNING



ELECTRICAL SHOCK HAZARD Do not open the equipment.

Hazardous voltage exists inside the equipment. Refer repair to authorized service personnel.



Immediately turn off the power at the switchboard if something is dropped into the equipment.

Continued use of the equipment can cause fire or electrical shock.



Immediately turn off the power at the switchboard if the equipment is emitting smoke or fire.

Continued use of the equipment can cause fire or electrical shock. Contact a FURUNO agent for service.



Immediately turn off the power at the switchboard if the equipment shows any abnormality.

If the unit exhibits any sign of abnormal heat or sound, turn the power off at the switchboard and consult a FURUNO agent or dealer.



Use only the specified power and signal cable.

Fire or damage to the equipment can result if a different cable is used.



WARNING



Use the proper fuse.

Use of an incorrect fuse can damage the equipment and can cause fire.



Do not put containers with liquids on the top of the equipment.

Fire, electrical shock or injury can result.



Keep the equipment away from rain and water splash.

Fire, electrical shock or injury can result if water leaks into the equipment



Do not disassemble or modify the equipment.

Fire, electrical shock or injury can result.







Do not operate the equipment with wet hands.





Electrical shock can result.



Do not steer vessel using the depth data alone.

Grounding and serious injury may result.

 CAUTION	
	<p>Do not use depth information for navigation while the picture advance speed is set to "stop".</p> <p>The depth indication is not refreshed while the picture is stopped. Use of depth data for navigation in this case could lead to grounding or other dangerous situation.</p>
	<p>Do not transmit with the transducer out of water.</p> <p>The transducer will be damaged.</p>
	<p>Keep the following points in mind regarding cables.</p> <ul style="list-style-type: none"> • Keep the cables away from lubricants and fuels. • Avoid areas where the cable may be damaged. • Do not paint the cables. Solvents such as toluene, contained in paints, can damage the cable's protective covering. • Do not cut the cables. The cables may be damaged or become corroded. • Do not carry the equipment using only the cables. The cables may be damaged or become disconnected.



 CAUTION	
	<p>Adjust the gain properly.</p> <p>Too little gain may present no picture. Too much gain shows excessive noise on the picture.</p>
	<p>Keep the bottom echo and depth indication shown stably.</p> <p>Unstable bottom echo and depth indication can result in grounding if the vessel is steered according to the depth information shown on the display. If unstable, adjust the setting of [Bottom Level] or [TX Power].</p>
	<p>Do not connect/disconnect the cables from a unit while the unit is powered.</p> <p>The unit may be damaged.</p>

Warning Label

A warning label is attached to both the Processor Unit and Transceiver Unit. Do not remove either label. If a label is missing or illegible, contact your local dealer regarding replacement.

 WARNING 
To avoid electrical shock, do not remove cover. No user-serviceable parts inside.
 警告 
感電の恐れあり。 サービスマン以外の方はカバーを開けないで下さい。内部には高電圧部分が多くあり、万一さわると危険です。

Name: Warning Label (1)
Type: 86-003-1011-3
Code No.: 100-236-233-10
Location: Processor Unit

	 DANGER
	Electrical shock hazard. Do not remove cover. No user-serviceable parts inside. Turn off power before servicing. And wait until charge lamp (green) goes off and then remove cover.
	 危険
	感電の恐れあり。 サービスマン以外の方は、カバーを開けないでください。内部には高圧部品が多くあり、万一さわると危険です。 サービスマンがカバーを開ける場合は、電源をOFFした後、CHARGEランプ(緑)が消灯していることを確認してから開けてください。

Name: Warning Label
Type: 10-079-6144
Code No.: 100-310-880-10
Location: Transceiver Unit

TABLE OF CONTENTS

FOREWORD	viii
SYSTEM CONFIGURATION	xi
1. OPERATION	1-1
1.1 Trackball Control Unit.....	1-1
1.2 How to Turn the Power On/Off.....	1-2
1.3 Fish Finder Display	1-2
1.3.1 Display overview	1-2
1.3.2 How to read the header.....	1-4
1.3.3 How to read the footer.....	1-5
1.3.4 How to use the InstantAccess bar™	1-5
1.3.5 InstantAccess bar™ icons list	1-7
1.4 How to Change Display Modes.....	1-11
1.4.1 How to change the display mode for the FCV-38	1-11
1.4.2 How to adjust the split screen division	1-13
1.5 Advanced Settings Menu	1-14
1.6 Picture Advance	1-15
1.6.1 Picture advance for FCV-38 and external echo sounders where "External Fish Finder Window" is set to "Off" at installation	1-15
1.6.2 Picture advance for external echo sounders where "External Fish Finder Window" is set to "On" at installation	1-16
1.7 How to Adjust the Gain	1-17
1.7.1 How to adjust the gain for the FCV-38.....	1-17
1.7.2 How to adjust the gain for external echo sounders where "External Fish Finder Window" is set to "Off" at installation	1-18
1.7.3 How to adjust the gain for external echo sounders where "External Fish Finder Window" is set to "On" at installation	1-18
1.8 How to Shift the Display Range	1-19
1.8.1 How to shift the display range for the FCV-38 and external echo sounders where "External Fish Finder Window" is set to "Off" at installation.....	1-19
1.8.2 How to shift the display range for external echo sounders where "External Fish Finder Window" is set to "On" at installation	1-19
1.9 How to Change the Range.....	1-20
1.9.1 How to change the range for FCV-38 and external echo sounders where "External Fish Finder Window" is set to "Off" at installation.....	1-20
1.9.2 How to change the range for external echo sounders where "External Fish Finder Window" is set to "On" at installation	1-21
1.10 How to Reject Interference.....	1-21
1.10.1 Interference rejection for the FCV-38.....	1-21
1.10.2 Interference rejection for external echo sounders where "External Fish Finder Window" is set to "Off" at installation	1-22
1.10.3 Interference rejection for external echo sounders where "External Fish Finder Window" is set to "On" at installation	1-22
1.11 How to Use the Smoothing Function.....	1-23
1.11.1 How to use smoothing for the FCV-38.....	1-23
1.11.2 How to use smoothing for external echo sounders where "External Fish Finder Window" is set to "Off" at installation	1-23
1.11.3 How to use smoothing for external echo sounders where "External Fish Finder Window" is set to "On" at installation	1-24
1.12 How to Reject Clutter	1-24
1.12.1 How to reject clutter for the FCV-38.....	1-24

1.12.2	How to reject clutter for external echo sounders where "External Fish Finder Window" is set to "Off" at installation.....	1-25
1.12.3	How to reject clutter for external echo sounders where "External Fish Finder Window" is set to "On" at installation.....	1-25
1.13	Zoom Modes.....	1-26
1.13.1	Bottom lock mode.....	1-27
1.13.2	Bottom zoom mode	1-28
1.13.3	Marker zoom mode	1-28
1.13.4	Bottom discrimination mode	1-29
1.14	How to Switch Between Daytime and Nighttime Color Modes	1-30
1.15	How to Use the A-scope Display	1-31
1.16	How To Show/Hide The Depth Indication.....	1-31
1.17	How To Show/Hide The Depth Scale	1-31
1.18	How to Measure Depth and Position of a School of Fish	1-32
1.19	How To Show/Hide The Minute Marker.....	1-33
1.20	How To Show/Hide The Color Bar	1-33
1.21	External Fish Finder Window.....	1-33
1.21.1	How to change the display mode	1-34
1.21.2	How to use the ACCU-FISH™ feature.....	1-34
1.22	How to Set, Show and Hide Alarms	1-36
1.22.1	How to activate/deactivate the alarms.....	1-37
1.22.2	How to set the alarms.....	1-38
1.23	How To Show/Hide Navigation Data	1-39
1.24	How to Inscribe TLL Lines	1-40
1.25	How to Use the Scroll Back Mode	1-40
1.26	How to Erase Weak Echoes.....	1-41
1.26.1	How to erase weak echoes for the FCV-38 and external echo sounders	1-41
1.26.2	How to erase weak echoes for external echo sounders where "External Fish Finder Window" is set to "On" at installation	1-42
1.27	How to Adjust TVG (Time Varied Gain).....	1-42
1.27.1	How to adjust TVG for FCV-38.....	1-43
1.27.2	How to adjust TVG for external echo sounders where "External Fish Finder Window" is set to "Off" at installation.....	1-43
1.27.3	How to adjust TVG for external echo sounders where "External Fish Finder Window" is set to "On" at installation.....	1-44
1.28	How to Save and Load Settings	1-44
1.28.1	How to save settings	1-44
1.28.2	How to load settings.....	1-45
1.29	How to Undo/Redo Operations.....	1-46
2.	GRAPH FUNCTIONS	2-1
2.1	How to Show/Hide Graphs	2-1
2.2	Fish Size Graph.....	2-2
2.2.1	How to show/hide the fish size graph	2-3
2.2.2	How to set the method of measurement	2-3
2.2.3	Entire area	2-3
2.2.4	Specific range.....	2-4
2.2.5	Bottom trace	2-5
2.2.6	Specific area.....	2-6
2.2.7	How to change fish size graph settings.....	2-7
2.3	Target Graphs	2-10
2.3.1	Vertical target graph	2-10
2.3.2	Horizontal target graph.....	2-11
2.3.3	How to change the graph scale (target graphs only).....	2-11
2.4	Sonde Graph	2-12
2.5	Temp Graph	2-12

TABLE OF CONTENTS

2.6	Bottom Information Graphs.....	2-13
2.6.1	Hardness graph.....	2-13
2.6.2	Roughness graph.....	2-14
3.	SCREENSHOTS & DATA RECORDING.....	3-1
3.1	Screenshots (still images).....	3-1
3.1.1	How to set the save destination for screenshots.....	3-1
3.1.2	How to take a screenshot.....	3-2
3.1.3	How to take screenshots at a set interval	3-2
3.1.4	How to replay a screenshot.....	3-3
3.1.5	How to copy screenshots from internal to external memory	3-4
3.1.6	How to delete screenshot files	3-4
3.2	Echo Data Recording and Playback	3-5
3.2.1	How to set the echo data recording format	3-5
3.2.2	How to record echo data.....	3-5
3.2.3	How to play back recorded echo data.....	3-6
3.3	How to Select an External Memory Device.....	3-9
4.	ADVANCED SETTINGS	4-1
4.1	How to Access the Advanced Settings Menu	4-1
4.2	Sounder Menu.....	4-2
4.3	Display Menu	4-3
4.4	Fish Size Menu	4-5
4.5	Alarm Menu.....	4-6
4.6	External Echo Sounder Menu	4-6
4.6.1	Sounder menu.....	4-7
4.6.2	Calibration menu.....	4-8
4.6.3	TX/RX menu.....	4-9
4.7	System Menu	4-10
4.7.1	Range menu.....	4-10
4.7.2	TX/RX menu.....	4-11
4.7.3	Control unit menu.....	4-16
4.7.4	User Interface Settings menu.....	4-17
4.7.5	Calibration menu	4-18
4.7.6	Calibration Settings menu	4-19
4.7.7	Stabilization menu.....	4-19
4.7.8	Mode menu	4-21
4.7.9	Tests menu	4-23
4.8	External Fish Finder	4-23
4.8.1	Sounder menu.....	4-23
4.8.2	Display menu	4-25
4.8.3	Measurement menu	4-25
4.8.4	System menu	4-26
5.	CALIBRATION	5-1
5.1	Overview	5-1
5.2	Preparation.....	5-1
5.2.1	Necessary parts	5-1
5.2.2	How to bind the standard sphere	5-2
5.2.3	How to select the measurement area	5-2
5.3	How to Set the Calibration Tools.....	5-3
5.3.1	How to set the fishing rod.....	5-3
5.3.2	How to swing rope under the ship bottom.....	5-4
5.3.3	How to set the standard sphere	5-5
5.4	Calibration.....	5-7
5.4.1	Calibration procedure.....	5-7

5.4.2	Operations available during the measurement.....	5-13
5.4.3	Operations available after completion of the measurement	5-15
6.	MAINTENANCE AND TROUBLESHOOTING.....	6-1
6.1	Maintenance	6-1
6.2	Trackball Maintenance	6-2
6.3	Fuse Replacement	6-3
6.4	Battery Replacement	6-3
6.5	Troubleshooting.....	6-4
6.6	Error Messages and Icons.....	6-5
6.7	Tests Menu.....	6-6
6.7.1	How to run the maintenance information test.....	6-7
6.7.2	Communication port monitor	6-7
6.7.3	How to test the Control Unit	6-9
6.7.4	LCD test	6-10
APPX. 1	MENU TREE.....	AP-1
APPX. 2	SCREEN LAYOUTS	AP-6
SPECIFICATIONS		SP-1
INDEX		IN-1
Operator's Guide		

FOREWORD

A Word to the Owner of the FCV-38

Congratulations on your choice of the FCV-38 Fish Finder and Stabilized Fish Size Indicator. We are confident you will see why the FURUNO name has become synonymous with quality and reliability.

Since 1948, FURUNO Electric Company has enjoyed an enviable reputation for innovative and dependable marine electronics equipment. This dedication to excellence is furthered by our extensive global network of agents and dealers.

Your equipment is designed and constructed to meet the rigorous demands of the marine environment. However, no machine can perform its intended function unless properly installed and maintained. Please carefully read and follow the operation and maintenance procedures set forth in this manual.

We would appreciate feedback from you, the end-user, about whether we are achieving our goal. Thank you for considering and purchasing FURUNO.

Features

The FCV-38 is a color fish finder with split-beam technology for estimating fish sizes. The system is comprised of a Trackball Control Unit, Processor Unit, Transceiver Unit, and Transducer. The FCV-38 shows underwater conditions on a monitor (local supply).

- Multi-directional beam transmission and reception provides simultaneous search and display in a maximum of five directions.
- Fish-size graph allows estimation of fish distribution at a glance.
- Target location graph allows tracking of a designated fish target.
- Hardness and roughness graph allows monitoring of the seabed hardness and roughness
- Data recording and screen-shot function allow easy review of past echoes and recordings.
- Scroll-back mode allows the user to review past data.
- Gain changes are applied to all screens currently displayed (high and low frequencies only).
- Recorded data can be saved to an external recording device.
- Display up to three separate echo images; available with the connection of an externally networked fish finder (ex. Network Sounder DFF-3).
- With connection to a Satellite Compass™, constant stable display of echoes is achievable with the use of the heave offset function.
- Fish target position information can be output to navigation equipment.
- ACCU-FISH provides an estimate of the size of individual fish. (Requires connection to an external display and an external fish finder with ACCU-FISH™ compatible transducer.)
- Data output and calibration functions for researchers.

Cautionary notes regarding external memory devices

- External memory devices that support USB2.0 or USB3.0 can be used with this equipment. The maximum useable USB cable lengths are 5 m for USB2.0 and 3 m for USB3.0. When connecting an external memory device via the trackball control unit, keep the total cable length between the trackball control unit and the device within 5 m.
- Do not use password-locked memory devices.
- Do not remove or disconnect the memory device while data is being saved or loaded. This can cause data corruption or loss.
- Do not connect, or disconnect, memory devices from the FCV-38 when it is turned on. Turn the power to the FCV-38 off before connecting or disconnecting a memory device.
- For external hard drives, drives with a separate, external power supply are recommended.
- When recording echo data (see section 3.2), a memory device with 500 GB capacity or higher is recommended.
- When recording echo data and saving screenshots, connect the memory device to the USB port of the Processor Unit. Do not connect memory devices to the Trackball Control Unit's USB port.
- Log output can require up to 2.4 GB capacity. Where the memory device has insufficient capacity, the log is output until the capacity is full. Any log entries after that point are not saved.
- The following memory devices are known to be compatible with this system:

External memory device	Maker	Model	Capacity
USB Flash Memory	Silicon Power	SP016GBUF3B02V1K	16 GB
	San Disk	SDCZ33-016G-J57	16 GB
	Kingston	DT100G3/16GB	16 GB
	Elecom	MF-HMU208GWH	8 GB
USB External Hard Drive	Buffalo	HD-LD2.0U3-BKA	2 TB

Licensed software

This product includes software licensed under Prism, NetCDF4, and others. Please refer to the following for details on the terms of the software.

Prism

The MIT License (MIT)

Copyright (c) NET Foundation

All rights reserved. Permission is hereby granted, free of charge, to any person obtaining a copy of this software and associated documentation files (the "Software"), to deal in the Software without restriction, including without limitation the rights to use, copy, modify, merge, publish, distribute, sublicense, and/or sell copies of the Software, and to permit persons to whom the Software is furnished to do so, subject to the following conditions:

The above copyright notice and this permission notice shall be included in all copies or substantial portions of the Software.

THE SOFTWARE IS PROVIDED "AS IS", WITHOUT WARRANTY OF ANY KIND, EXPRESS OR IMPLIED, INCLUDING BUT NOT LIMITED TO THE WARRANTIES OF MERCHANTABILITY, FITNESS FOR A PARTICULAR PURPOSE AND NONINFRINGEMENT. IN NO EVENT SHALL THE AUTHORS OR COPYRIGHT HOLDERS BE LIABLE FOR ANY CLAIM, DAMAGES OR OTHER LIABILITY, WHETHER IN AN ACTION OF CONTRACT, TORT OR OTHERWISE, ARISING FROM OUT OF OR IN CONNECTION WITH THE SOFTWARE OR THE USE OR OTHER DEALINGS IN THE SOFTWARE.

FOREWORD

Net CDF4

Copyright 2018 Unidata

Redistribution and use in source and binary forms, with or without modification, are permitted provided that the following conditions are met:

- 1.Redistributions of source code must retain the above copyright notice, this list of conditions and the following disclaimer.
- 2.Redistributions in binary form must reproduce the above copyright notice, this list of conditions and the following disclaimer in the documentation and/or other materials provided with the distribution.
- 3.Neither the name of the copyright holder nor the names of its contributors may be used to endorse or promote products derived from this software without specific prior written permission.

THIS SOFTWARE IS PROVIDED BY THE COPYRIGHT HOLDERS AND CONTRIBUTORS "AS IS" AND ANY EXPRESS OR IMPLIED WARRANTIES, INCLUDING, BUT NOT LIMITED TO, THE IMPLIED WARRANTIES OF MERCHANTABILITY AND FITNESS FOR A PARTICULAR PURPOSE ARE DISCLAIMED. IN NO EVENT SHALL THE COPYRIGHT HOLDER OR CONTRIBUTORS BE LIABLE FOR ANY DIRECT, INDIRECT, INCIDENTAL, SPECIAL, EXEMPLARY, OR CONSEQUENTIAL DAMAGES (INCLUDING, BUT NOT LIMITED TO, PROCUREMENT OF SUBSTITUTE GOODS OR SERVICES; LOSS OF USE, DATA, OR PROFITS; OR BUSINESS INTERRUPTION) HOWEVER CAUSED AND ON ANY THEORY OF.

LIABILITY, WHETHER IN CONTRACT, STRICT LIABILITY, OR TORT (INCLUDING NEGLIGENCE OR OTHERWISE) ARISING IN ANY WAY OUT OF THE USE OF THIS SOFTWARE, EVEN IF ADVISED OF THE POSSIBILITY OF SUCH DAMAGE.

Conventions used in this manual

For the sake of brevity, the procedures in this manual use the following conventions:

Action	Meaning
Left-click	Press the Left button once.
Double-click	Press the Left button two times, in succession.
Right-click	Press the Right button once.
Drag and drop	Highlight the item with the cursor, then press and hold the Left button. Use the Trackball to move, or "drag," the item. Release the Left button to "drop" the item.
Scroll	Scroll with the scrollwheel.
External Fish Finder	Used in reference to an external echo sounder connected to the FCV-38. For example, DFF3.

CE/UKCA declaration

With regards to CE/UKCA declaration, please refer to our website (www.furuno.com) for further information about RoHS conformity declarations.

Disclosure of Information about China RoHS

With regards to China RoHS information for our products, please refer to our website (www.furuno.com).

SYSTEM CONFIGURATION

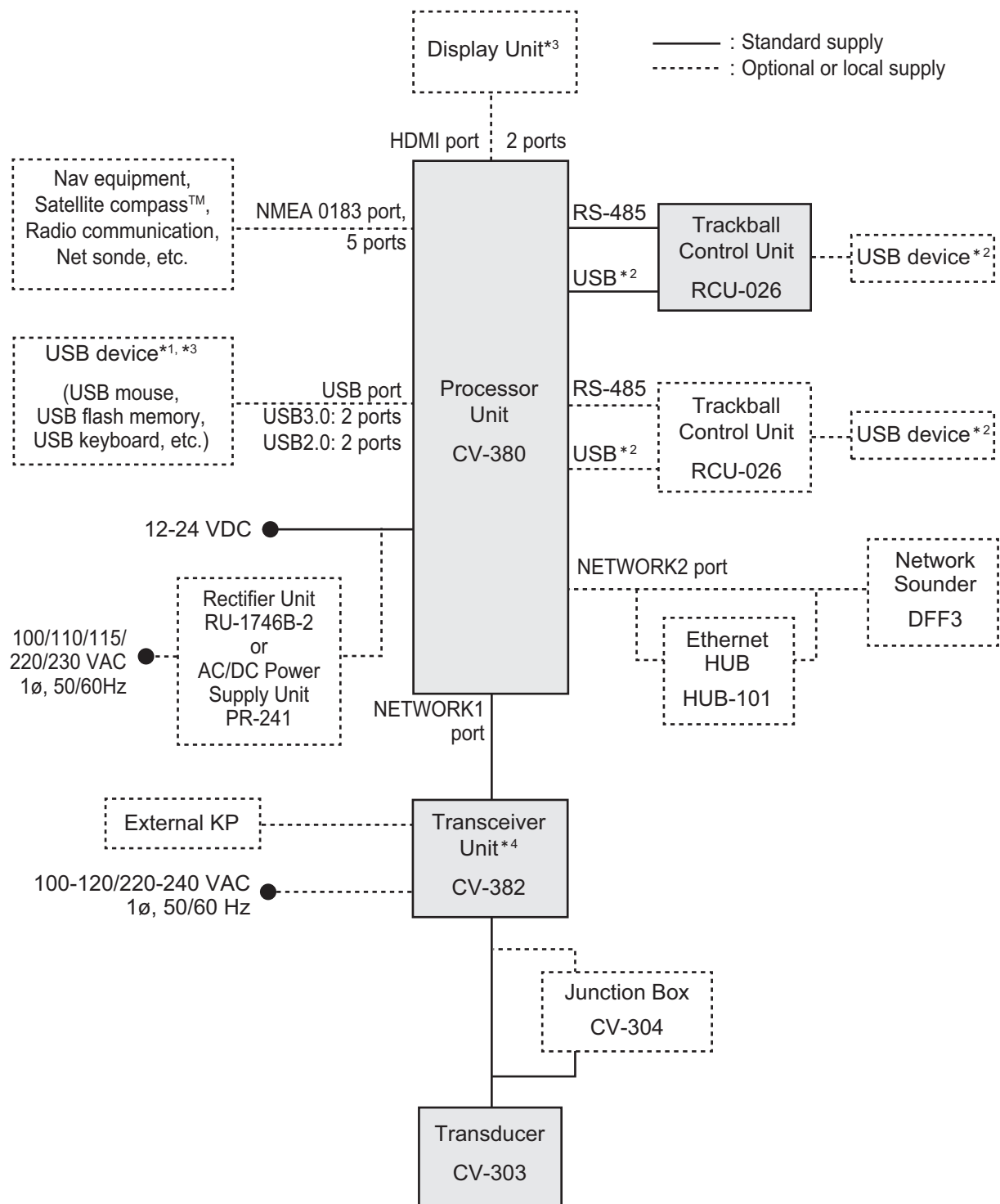

- *1: A maximum of four USB devices including RCU-026 can be connected to the processor unit.
- *2: To use the USB port on the RCU-026, connect the RCU-026 to the USB port on the processor unit, using the USB cable supplied with the RCU-026. If you do not use the USB port on the RCU-026, the USB connection between the RCU-026 and processor unit is not required.
- *3: To extend the distance between the processor unit and the monitor unit/USB device, use the optional DVI/USB repeater.
- *4: The transceiver unit CV-302 for FCV-30 is available.

This page is intentionally left blank.

1. OPERATION

1.1 Trackball Control Unit

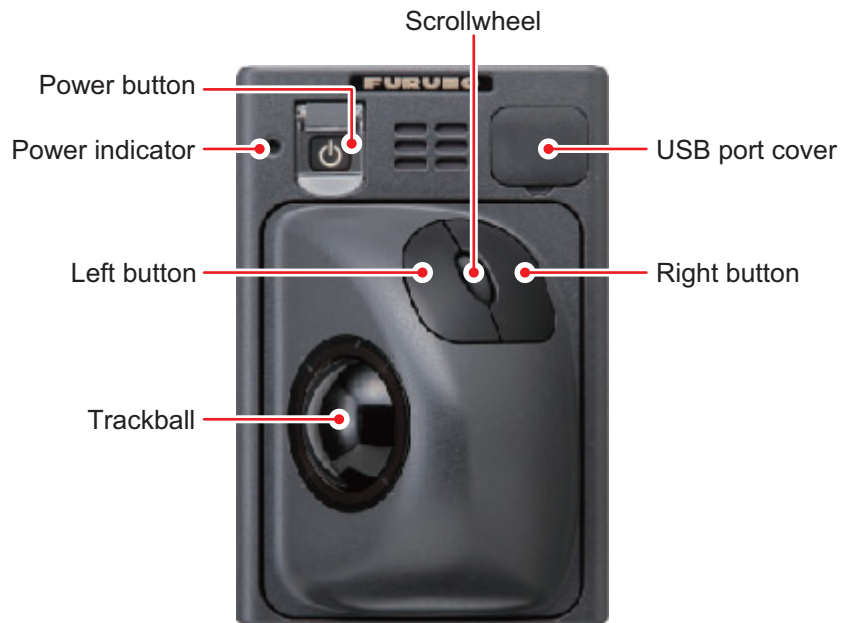

Item	Function, description
Power button (⏻)	Press to turn the power on or off.
Power indicator	Lights green when the power is on.
Trackball	Moves the cursor.
Left button	Click: Selects the item highlighted with the cursor. Double click: Output Target Latitude and Longitude (TLL). Long push: Moves the selected window, marker line, etc.
Right button	Short push: Shows/hides the InstantAccess bar™. Long push: Starts the scroll back mode. Confirms picture when the scroll back mode is active.
Scrollwheel	Scroll: Changes the setting for the selected item. Short push: Takes a screenshot (still image). Long push: Replays screenshots.
USB port cover	Open to access the USB port, where a USB flash memory can be inserted. When the USB port is not in use, cover the USB port with the port cover. Note: Do not use this port to connect external memory devices for data recording or saving screenshots.

1.2 How to Turn the Power On/Off

Open the power button cover on the Trackball Control Unit, then push the power button (⏻). An audible "beep" indicates that the power is now on, then the start-up screen appears. The brilliance of the power lamp on the Trackball Control Unit can be adjusted with [Brightness] in the [Control Unit] menu. See section 4.7.3.

To turn the power off, open the power button cover, then push the power button.

Note 1: Always use the Trackball Control Unit to turn the system on or off. If the system is turned off from a switchboard or by other means, changes made to settings are not saved.

Note 2: The Transceiver Unit uses a small amount of power when it is off. When the system will not be used for a long period of time, turn the system off from the switchboard. Power consumption in stand-by is 30mA.

1.3 Fish Finder Display

1.3.1 Display overview

The figure below shows a typical fish finder display. Some indications are not shown in this example, however all functions and indications are covered later in this manual.

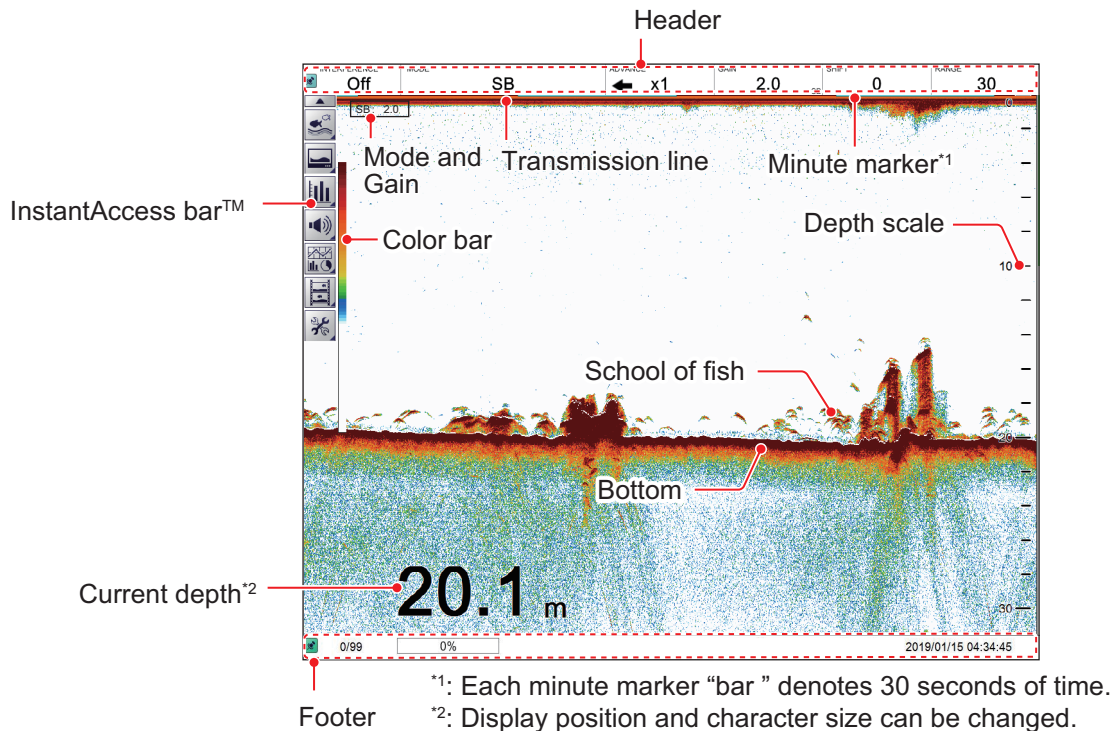

Display example (split beam single display)

How to change the position and size of the depth indication

Place the cursor near the depth indication, and a window frame appears. Drag and drop the window to the location desired for the depth indication. Drag and drop the window frame to change the size of the depth indication.



1

Operations available with two monitors

The setting of [Sub Monitor Display Switching], which is set at installation, determines what appears on the sub monitor.

- [Dual]: The sub monitor shows the FCV-38 logo. Windows such as graphs can be dragged from the main monitor to the sub monitor, as shown in the figure below. Further, the picture from an external fish finder can be shown depending on the setting for the external fish finder window. See section 1.21.

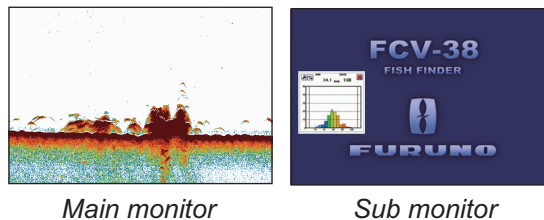

- [Clone]: Clones the picture on the main monitor to the sub monitor.

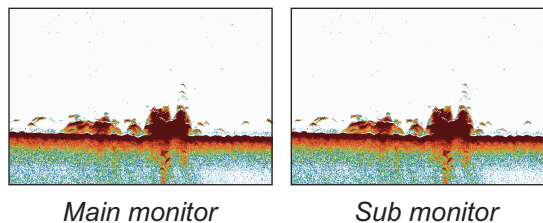

1. OPERATION

1.3.2 How to read the header

The header contains various settings and controls, all accessible with the cursor. Select an indication on the header to adjust that function.

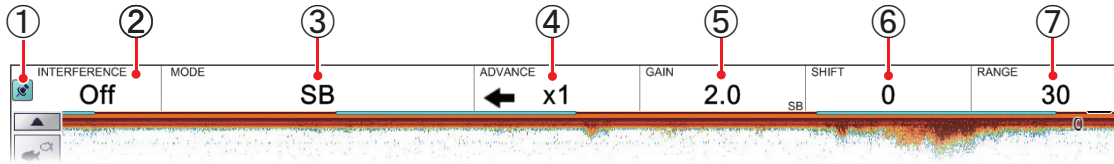

No.	Name	Description
1	"Pinned" icon	Selects the "Pinned" icon to "pin" or "unpin" the header. A "pinned" header is always visible at the top of the screen. An "unpinned" header is hidden until the cursor is placed on the header's location. This icon is shown in green color when "pinned".
2	Miscellaneous settings	Selects the indication to activate the current function, then scroll to select the desired setting. The functions available from this section of the header are: <ul style="list-style-type: none"> • Interference rejection. See section 1.10. • Smoothing. See section 1.11. • Clutter. See section 1.12. • Zoom mode. See section 1.13. • Fish size measurement-bottom zoom. See section 2.2.5. • Fish size measurement-specific area. See section 2.2.6. • External fish finder Gain.* See section 1.7.2. * Available when the external fish finder window setting, which is set at installation, is "OFF".
3	[MODE]	Selects the Display mode. See section 1.4 for available modes.
4	[ADVANCE]	Selects the speed at which echoes are scrolled across the screen. See section 1.6.
5	[GAIN]	Selects the transducer sensitivity level. See section 1.7.
6	[SHIFT]	Shifts the displayed area. See section 1.8.
7	[RANGE]	Changes the displayed range. See section 1.9.

1.3.3 How to read the footer

The footer displays the date and time, how many screenshots are saved, and the amount of space available in the external memory.

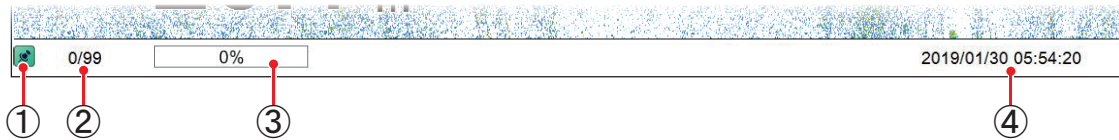

No.	Name	Description
1	"Pinned" icon	The footer can be "pinned" or "unpinned". A "pinned" footer is always visible at the bottom of the screen. An "unpinned" footer is hidden until the cursor is placed on the footer's location. This icon is shown in green color when "pinned".
2	Internal memory screenshot counter	Shows the number of screenshots stored in the internal memory and the total capacity available. For example, if the indication reads "9/99", this means that nine screenshots are saved and the total capacity is 99 screenshots.
3	External memory capacity	Shows the available capacity on the external memory device. When no device is connected, the indication is "0%".
4	Current date/time	Shows the current date and time.

1.3.4 How to use the InstantAccess bar™

The InstantAccess bar™ is the vertical bar left edge of the screen. The bar contains the menus for functions and features, all in one compact icon-based format. You can show the InstantAccess bar™ by clicking (▼), hide it by clicking (▲). Another method to show/hide the InstantAccess bar™ is to place the cursor on a non-interactive section of the display, then right-click.

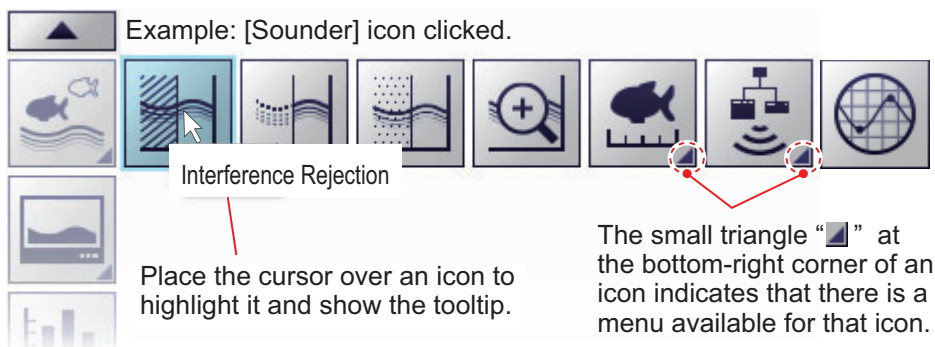

How to create and remove shortcuts

Most icons displayed on the InstantAccess bar™ can be stored as shortcuts (on the shortcut bar) and displayed always. Shortcuts are useful for accessing frequently used functions. Up to ten icons can be assigned to the shortcut bar. The shortcuts are displayed only when the InstantAccess bar™ is hidden.

To create a shortcut, drag and drop the desired icon into the shortcut area.

Note 1: The icons [Internal Settings 1]() - [Internal Settings 8]() (see section 1.28) cannot be stored as shortcuts.



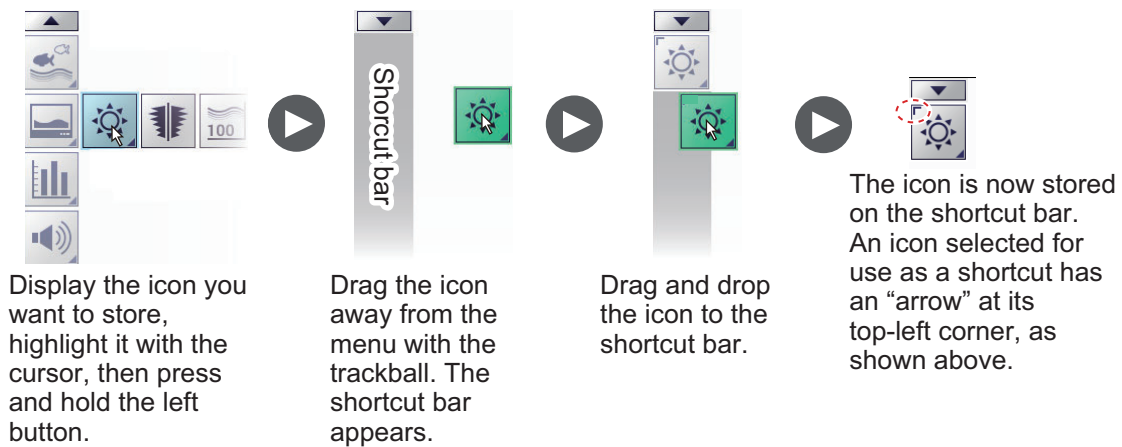











Note 2: You can cancel a drop and drag operation in progress by right-clicking.















To remove an icon from the shortcut bar, drag the icon out of the shortcut bar area.

















1.3.5 InstantAccess bar™ icons list

The table below shows the InstantAccess bar™ menus, their respective menu items and available options, along with a brief description. For full details on each menu/function, see the respective sections of the manual.















Icon		Description/Options
Menu	Item	
		[Sounder] menu. Accesses the sounder-related settings.
		[Interference Rejection] icon. Accesses the [Interference Rejection] function. See section 1.10.
		[Smoothing] icon. Accesses the [Smoothing] function. See section 1.11.
		[Clutter] icon. Accesses the [Clutter] (low level noise reduction) function. See section 1.12
		[Zoom Mode] icon. Accesses the [Zoom] functions. See section 1.13.
		[Measure Fish Size] icon. Accesses the fish measurement area settings. See section 2.2.2. The available settings are: <ul style="list-style-type: none">  Measures fish over the entire display. See section 2.2.3.  Measures fish within a specified depth range. See section 2.2.4.  Measures fish that appear near the seabed. See section 2.2.5.  Measures fish within a specified area on the display. See section 2.2.6.
		[External Fish Finder Gain] icon. Adjusts the external fish finder gain. See section 1.7. The available options are: <ul style="list-style-type: none">  Adjusts the high frequency external fish finder gain.  Adjusts the low frequency external fish finder gain. <p>Note: Available when the external fish finder window setting is "OFF".</p>
		[Calibration Range] icon. Activates/deactivates the calibration range display. See section 5.4.













1. OPERATION

Icon		Description/Options
Menu	Item	
		[Display] menu. Accesses the display-related settings.
		[Window Color] menu. Changes the display colors to suit day or night viewing. See section 1.14. The available options are:  — Sets the display colors for Daytime viewing.  — Sets the display colors for Nighttime viewing.
		[A-Scope] icon. Shows/hides the A-Scope. See section 1.15.
		[Depth] icon. Shows/hides the depth indication. See section 1.16.
		[Depth Scale] icon. Shows/hides the depth scale. See section 1.17.
		[Horizontal VRM] icon. Shows/hides the horizontal VRM line. See section 1.18.
		[Vertical VRM] icon. Shows/hides the vertical VRM line. See section 1.18.
		[Minute Marker] icon. Shows/hides the minute marker. See section 1.19.
		[Color Bar] icon. Shows/hides the color bar. See section 1.20.
		[External Echo Sounder] icon. Shows/hides echoes from the external echo sounder on the sub display. Note: The [External Echo Sounder] icon is not available when the [External Fish Finder Window] menu option is set to [Off] at installation.

Icon		Description/Options
Menu	Item	
		[Graph] menu. Accesses the graph functions. See chapter 2.
		[Fish Size Graph]. Activates/deactivates the fish size graph and measurement functions. See section 2.2.
		[Target Graph] icon Activates/deactivates the horizontal and vertical target graphs. See section 2.3. The available options are  Activates/deactivates the vertical target graph.  Activates/deactivates the horizontal target graph
		[Sonde Graph]. Activates/deactivates the sonde graph. See section 2.4.
		[Temp Graph]. Activates/deactivates the water temperature graph. See section 2.5.
		[Bottom Information Graph]. Activates/deactivates the bottom hardness and bottom roughness graphs. See section 2.6. The available options are  Activates/deactivates the bottom hardness graph.  Activates/deactivates the bottom roughness graph.
		[Alarm] menu. Activates/deactivates alarms. See section 1.22.
		[Bottom Alarm] icon. Activates/deactivates the bottom (seabed) alarm.
		[Fish Alarm] icon. Activates/deactivates the fish alarm.
		[Bottom Fish Alarm] icon. Activates/deactivates fish alarm for fish near the seabed.
		[Water Temperature Alarm] icon. Activates/deactivates the water temperature alarm.
		[Fish Size Graph Alarm] icon. Activates/deactivates the fish size alarm.

1. OPERATION

Icon		Description/Options
Menu	Item	
		[Data Display] menu. Accesses external data. See section 1.23.
		[Own Ship Position] icon. Shows/hides own ship latitude and longitude.
		[Time and Date] icon. Shows/hides the time and date.
		[Speed(SOG)] icon. Shows/hides your vessel's speed over the ground.
		[Speed(STW)] icon. Shows/hides your vessel's speed through the water.
		[Temperature] icon. Shows/hides the water temperature.
		[Timer] icon. Shows/hides the timer indication, which appears at the top-left corner on the screen.
		[Roll Pitch Heave] icon. Shows/hides the roll, pitch and heave indications, which appear at the top-left corner on the screen.
		[Echo Recording] menu. Accesses the echo recording and screenshot recording functions.
		[Record] icon. Starts recording echo data. See section 3.2.2.
		[Play] icon. Plays back echo data. See section 3.2.3.
		[Pause] icon. Pauses the echo data playback. See section 3.2.3.
		[Stop] icon. <ul style="list-style-type: none"> • Stops echo data recording. See section 3.2.2. • Stops echo data playback. See section 3.2.3.
		[Multi-Screenshot Start/Stop] icon. Takes multiple screenshots. See section 3.1.3.

Icon		Description/Options
Menu	Item	
		[Advanced Settings] menu. Accesses the advanced settings menu, change various settings for the FCV-38 and undo/redo actions.
		[Internal Settings] menu. Saves/Loads data to/from the Processor Unit's internal memory. See section 1.28.  [Save Settings] icon: Saves current settings to media set to the Processor Unit.*  [Load Settings] icon: Loads settings from the media set to the Processor Unit. *Eight sets of settings ( ~ )
		[External Settings] menu. Saves/Loads data to/from an external memory device. See section 1.28.  [Save External Unit Settings] icon: Saves current settings to an external memory device.  [Load External Unit Settings] icon: Loads settings from an external memory device.
		[Advanced Settings] icon. Accesses the [Advanced Settings] pop-up menu. See section 1.5 and chapter 4.
		[Undo] icon. "Undo" the last operation. See section 1.29.
		[Redo] icon. "Redo" the last operation. See section 1.29.
		[Select External Memory Device] icon. Accesses the external memory device which saves screenshots. See section 3.3. Note: Appears only when an external memory device is connected.

1.4 How to Change Display Modes

The FCV-38 has five base screens, split beam, multi-beam, zoom, external sounder-high frequency, and external sounder-low frequency. By combining screens you can see underwater objects from a wide variety of viewpoints. For how to combine screens, see section 4.7.8.

1.4.1 How to change the display mode for the FCV-38

Note: To change the display mode on the external fish finder window, see section 1.21.1.

1. If the header is not displayed, put the cursor at the top edge of the display to show it.

1. OPERATION

- Click the [MODE] indication on the header. The indication is now highlighted in a green color.

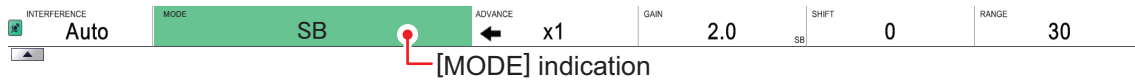

- Scroll to show the desired mode. The available modes depend on the [Mode] menu settings in the [System] menu. See section 4.7.8. The table below lists the modes with their abbreviation (as displayed on-screen) along with the meaning.

Abbreviation	Meaning
[SB]	Split mode display*. See below.
[B1] - [B5]	Beams 1 - 5*. See below.
[BL]	Bottom Lock mode. See section 1.13.1.
[BZ]	Bottom Zoom mode. See section 1.13.2.
[MZ]	Marker Zoom mode. See section 1.13.3.
[BD]	Bottom discrimination mode. See section 1.13.4.
[HE]	External HF sounder.
[LE]	External LF sounder.

* This equipment's echo sounder.

Note: In the default setting, the zoom display (window) and external sounder display are not shown. If you need to add some displays, see page 4-21. Additionally, the image from an external fish finder can be shown on a separate monitor. See section 1.21.

Split beam display

This split beam display shows the underwater images captured with split beam technology*. The fish size graph (section 2.2) provides information on the distribution of individual fish, and the target position graph (section 2.3) lets you monitor the movement of individual fish.

* A method of measuring the position and length of a single fish based on the phase difference of the echoes received by dividing the transducer into front and rear, left and right.

Beams 1 - 5 display

Images obtained by the multi-beam method (port direction, downward direction, starboard direction) are displayed. Simultaneous search and display in up to 5 directions. The default beam direction is as shown in the table below

Display	Beam direction (B: pair bearing angle, T: tilt angle)	Remarks
Beam 1	B: 90°, T: 10°	Starboard direction
Beam 2	B: 270°, T: 10°	Port direction
Beam 3	B: 90°, T: 20°	Starboard direction
Beam 4	B: 270°, T: 20°	Port direction
Beam 5	B: 0°, T: 0°	Downward direction

Note 1: Pair bearing and tilt angle can be changed. See page 4-15. Also, the beam direction indication format also can be changed. See page 4-5.

Note 2: The "simultaneous TX" feature permits simultaneous search. See page 4-12.

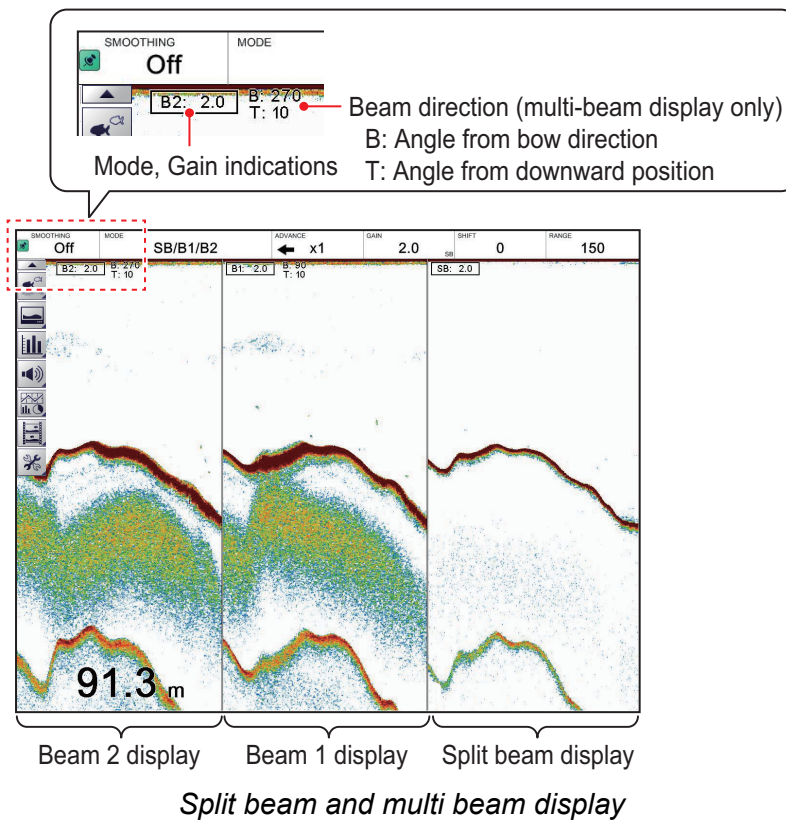

1.4.2 How to adjust the split screen division

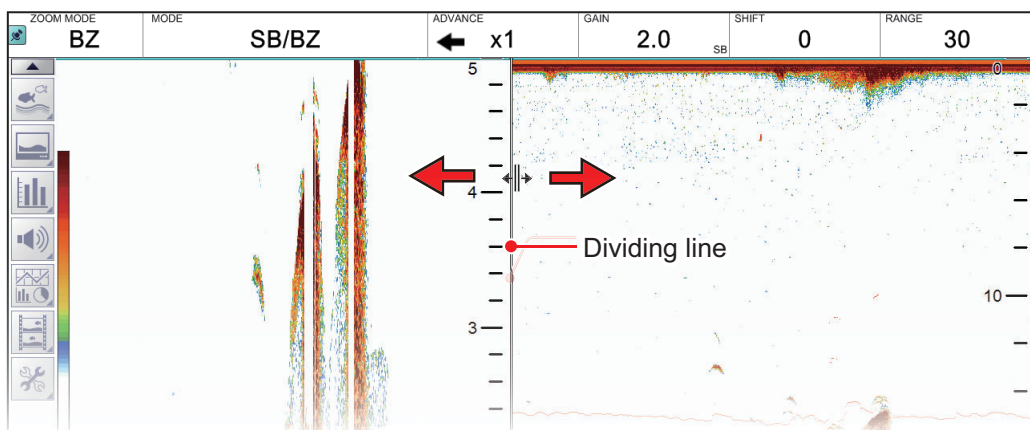

You can adjust the size of each division of a split screen to suit your requirements. To adjust the size of a split screen, do the following:

1. Put the cursor on the display dividing line. The cursor shape changes from (☞) to (⇄).
2. Drag the dividing line to resize the screens as required.



1.5 Advanced Settings Menu

The [Advanced Settings] menu contains less-often used functions for adjustment of the system.

1. Click the [Advanced Settings] icon () from the InstantAccess bar™, then click the [Advanced Settings] icon () to show the [Advanced Settings] window.

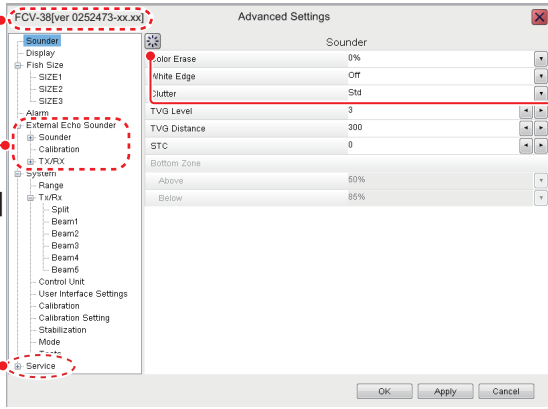

Software version (program number) "xx.xx" denotes minor changes.

Shown when external echo sounder is connected and [External Fish Finder Window] is set to [Off] (at installation).

Accessible only by service personnel.

Reset the current menu settings (right window) to factory default.

2. Use the trackball to click a menu item in the menu (left window). The selected menu item appears in the right window.
3. Use the trackball to click the item in the menu at the right side of the screen.

Note: A greyed-out setting value means the corresponding menu item cannot be changed.
4. Change the setting as necessary.

Item with options

- 1) Click the triangle (▼) to show a drop-down list.

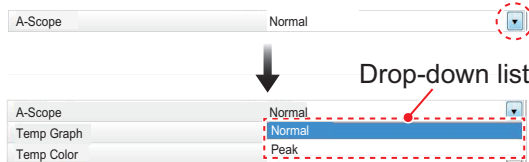

- 2) Select desired option from the list.

Item with numeric value

Click ◀ or ▶ to change the numeric value.

5. Confirm settings, then click the [OK] button.

To save settings without closing the menu, click the [Apply] button. To cancel changes, click the [Cancel] button.

1.6 Picture Advance

The picture advance speed determines how quickly the echoes are displayed on-screen. When setting a picture advance speed, keep in mind that a fast advance speed will expand echoes horizontally on the screen and a slow advance speed will contract them. A fast advance speed is useful for observing a rugged seabed closely. A slow advance speed is useful for observing a smooth seabed.

Note: When the ACCU-FISH™ feature is active, the picture advance speed may be slowed.



CAUTION

Neither the picture nor the depth indication is refreshed while the picture is stopped. Use of depth data for navigation in this case could lead to grounding or other dangerous situation.

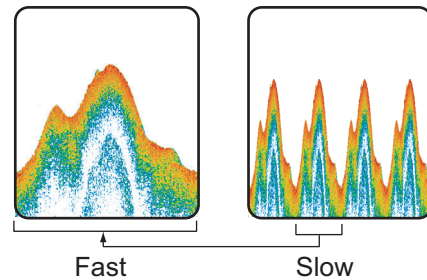

1.6.1 Picture advance for FCV-38 and external echo sounders where "External Fish Finder Window" is set to "Off" at installation

Where [External Fish Finder Window] is set to [Off] at installation, the picture advance setting is applied to both the FCV-38 and the external fish finder.

1. If the header is not displayed, put the cursor at the top edge of the display to show it.
2. Click the [ADVANCE] indication on the header. The indication is now highlighted in a green color.

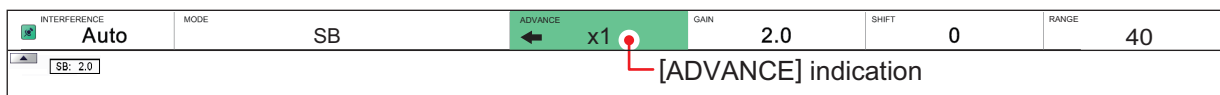

3. Scroll to select the appropriate advance speed. The table below lists each speed with a description.

[ADVANCE] indication	Description
[STOP]	Picture is "paused".
[1/16]	One sixteenth of the normal speed.
[1/8]	One eight of the normal speed.
[1/4]	One quarter of the normal speed.
[1/2]	Half the normal speed.
[x1]	Normal speed.
[x2]	Twice as fast as normal speed.
[x4]	Four times as fast as normal speed.
[x8]	Eight times as fast as normal speed.

1. OPERATION

1.6.2 Picture advance for external echo sounders where "External Fish Finder Window" is set to "On" at installation

Where [External Fish Finder Window] is set to [On] at installation, follow the procedure below.

1. Place the cursor inside the external fish finder screen, then right-click to show the [External Fish Finder] menu.

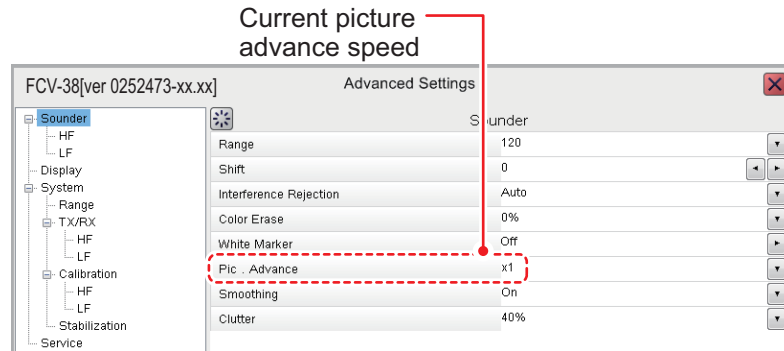

2. The [Sounder] item is already selected. At the right-side of the menu window, click [Pic. Advance].
3. Select the drop-down options button at the far right-hand side of the screen.
4. Select the appropriate speed.
5. Click [Apply] to save the current changes and change or adjust other settings.

1.7 How to Adjust the Gain

Depending on the signal strength, gain can be adjusted to hide noise and other unnecessary echoes. A high gain setting increases signal strength and can show excessive noise as well as smaller, hard to detect echoes. A low gain setting eliminates noise and gives a clearer picture, however smaller echoes may also be removed.

NOTICE

Adjust the gain properly.

Too little gain may present no picture.
Too much gain shows excessive noise on the picture.

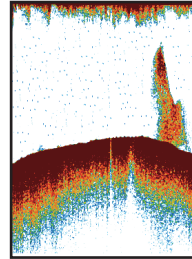

Too high

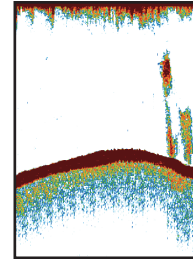

Proper

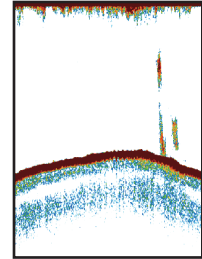

Too low

1.7.1 How to adjust the gain for the FCV-38



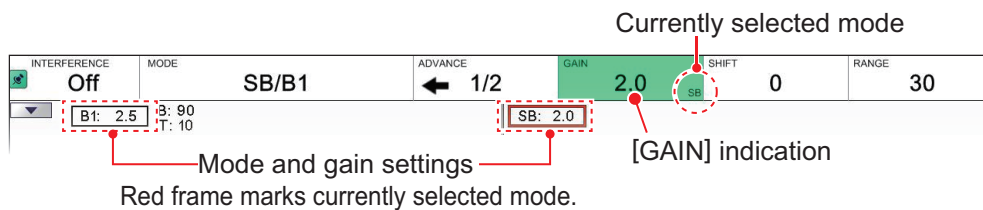

1. If the header is not displayed, put the cursor at the top edge of the display to show it.
2. Click the [GAIN] indication on the header. The indication is now highlighted in a green color.



3. Select one of the following gain adjustment methods.
 - Click the [GAIN] indication again. Each click changes the mode indication in the GAIN header in the sequence of [SB](Split Beam)→ [B1](Beam1)→ [B2](Beam2)→ [B3](Beam3)→ [B4](Beam4)→ [B5](Beam5)→ [SB]→... (inactive modes are skipped). For example, the [MODE] indication shows [B1/SB]. Then, each click of the [GAIN] indication switches between [SB] and [B1]. The red frame encloses the Mode, Gain indication of the image currently selected for adjustment.
 - Click the "Mode and gain settings indication" of the image that you want to adjust. The indication clicked is enclosed with the red frame, and the [GAIN] mode display changes accordingly.
4. Scroll to change the gain.
Scroll downward to increase the gain; upward to decrease the gain. The current gain setting appears in the [GAIN] indication. Adjust it so that a slight amount of noise appears on the screen.

1. OPERATION

1.7.2 How to adjust the gain for external echo sounders where "External Fish Finder Window" is set to "Off" at installation

1. Click the [Sounder] icon () from the InstantAccess bar™ to show the [Sounder] menu, then click the [External Fish Finder] icon (), and the high/low frequency icons appear.
2. Click the appropriate icon,  for low frequency,  for high frequency. The indication on the header changes to [EX GAIN LF] or [EX GAIN HF] respectively and the indication changes to a green color.

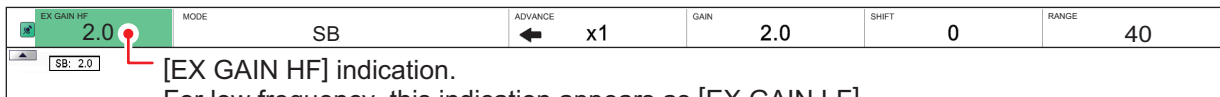

[EX GAIN HF] indication.
For low frequency, this indication appears as [EX GAIN LF].

3. Scroll to adjust the external fish finder's gain.

Note: The gain can also be adjusted by clicking the Mode and gain settings indication on the HE picture or LE picture. Scroll to adjust the gain.

1.7.3 How to adjust the gain for external echo sounders where "External Fish Finder Window" is set to "On" at installation

1. Place the cursor inside the external fish finder screen, then right-click to show the [External Fish Finder] menu.
2. The [Sounder] menu is already selected. Click the [HF] or [LF] item from the [Sounder] menu. The settings for the external fish finder appear in the right-side of the menu window.



Note: The menu for [HF] and [LF] are the same, the example above shows [HF]. Where [LF] is selected, set the items in a similar manner to this procedure.

3. Click the [Gain] item from the settings. The setting value is now highlighted.
4. To the far right-hand side of the gain value, select the ◀ button to decrease the gain, or select the ▶ button to increase the gain.
5. Click [Apply] to save the current changes and change or adjust other settings. Click [OK] to save the current changes and close the menu window. Click [Cancel] to abort all changes and close the menu window.

Note: The gain can also be adjusted by clicking the Mode and gain settings indication on the HE picture or LE picture. Scroll to adjust the gain.

1.8 How to Shift the Display Range

When used together, the basic range and range shifting functions allow you to select the depth you can see on the screen. The basic range can be thought of as providing a "window" into the water column and range shifting as moving the "window" to the desired depth.

Note: The seabed echo may be lost if the shift is at a greater value than the seabed depth.

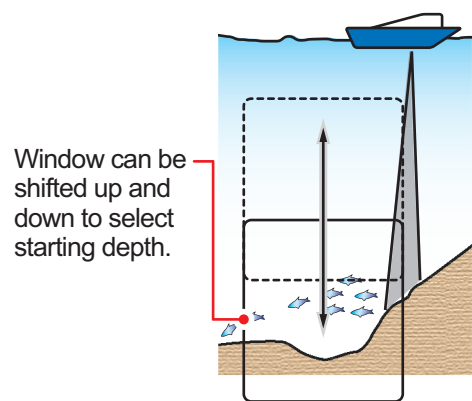

1

1.8.1 How to shift the display range for the FCV-38 and external echo sounders where "External Fish Finder Window" is set to "Off" at installation

Where [External Fish Finder Window] is set to [Off] at installation, the shift function is applied to both the FCV-38 and the external fish finder.

Note: This function is not available when auto range or auto shift is active.

1. Display the header if it is not "pinned". If the header is displayed, go to step 2.
2. Click the [SHIFT] indication on the header. The indication is now highlighted in a green color.

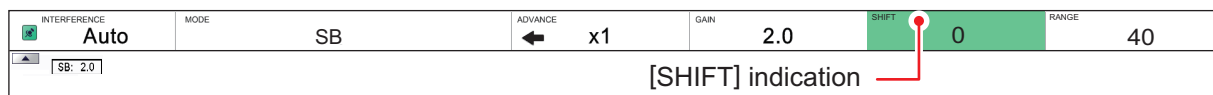

3. Scroll to change the amount of shift used. The current shift setting appears in on the header.

1.8.2 How to shift the display range for external echo sounders where "External Fish Finder Window" is set to "On" at installation

1. Place the cursor inside the external fish finder screen, then right-click. The [External Fish Finder] menu appears.
2. The [Sounder] item is already selected. At the right-side of the menu window, click [Shift].
3. To the far right-hand side of the [Shift] setting value, select the ◀ button to decrease the setting, or select the ▶ button to increase the setting.
4. Click [Apply] to save the current changes and change or adjust other settings. Click [OK] to save the current changes and close the menu window. Click [Cancel] to abort all changes and close the menu window.

1.9 How to Change the Range

The range setting dictates the on-screen display distance and can be changed to suit your requirements. The system has eight presets, each of which can be changed. The default setting for the presets is listed in the table below.

Unit of measurement & Connected fish finder	Preset ranges							
	1	2	3	4	5	6	7	8
m (FCV-38)	10	20	40	80	150	300	500	1000
m (DFF3 - On)	5	10	20	40	80	150	300	1500
ft (FCV-38)	30	60	120	250	500	1000	1600	3000
ft (DFF3 - On)	15	30	60	120	200	400	1000	4500
fa (FCV-38)	5	10	20	40	80	160	250	500
fa (DFF3 - On)	3	5	10	20	40	80	150	900
Hiro* (FCV-38)	6	12	25	50	100	200	300	600
Hiro* (DFF3 - On)	4	8	15	30	50	100	200	1200
pb (FCV-38)	6	12	25	50	100	200	300	600
pb (DFF3 - On)	3	5	10	30	50	100	200	900

*: Japanese unit of depth measurement.

Note: You can change the preset range for of the presets, according to your requirements. See section 4.7.1 or section 4.8.4.

1.9.1 How to change the range for FCV-38 and external echo sounders where "External Fish Finder Window" is set to "Off" at installation

Where [External Fish Finder Window] is set to [Off] at installation, the range is applied to both the FCV-38 and the external fish finder.

To change the range, follow the procedure below.

Note: Range cannot be adjusted manually when auto range is active.

1. If the header is not displayed, put the cursor at the top edge of the display to show it.
2. Click the [RANGE] indication on the header. The indication is now highlighted in a green color.

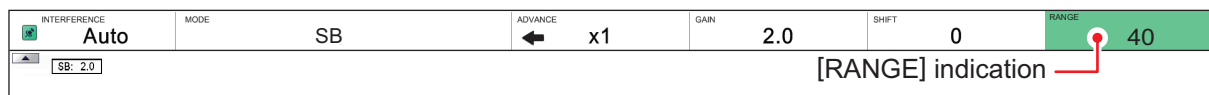

3. Scroll to change the range. The display changes automatically with each change in range.

1.9.2 How to change the range for external echo sounders where "External Fish Finder Window" is set to "On" at installation

1. Place the cursor inside the external fish finder screen, then right-click to show the [External Fish Finder] menu.
2. The [Sounder] item is already selected. At the right-side of the menu window, click [Range].
3. Select the drop-down options button to show the preset range settings.
4. Select the appropriate range.
5. Click [Apply] to save the current changes and change or adjust other settings. Click [OK] to save the current changes and close the menu window. Click [Cancel] to abort all changes and close the menu window.

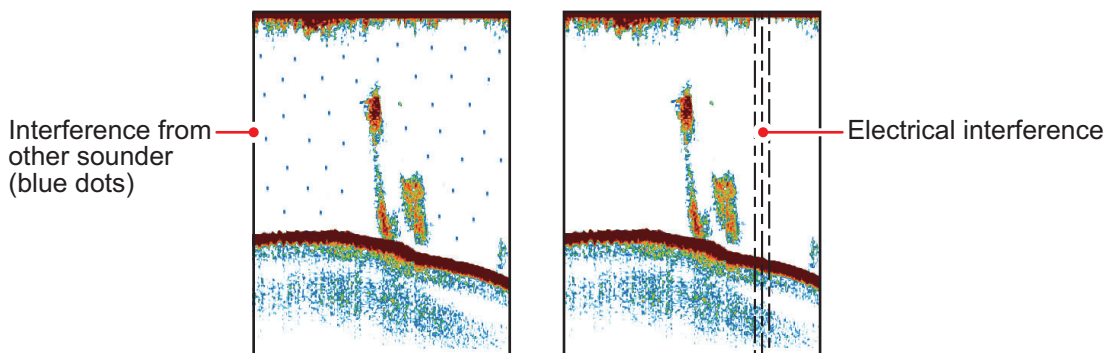

1.10 How to Reject Interference

Interference from other acoustic equipment operating nearby or other electronic equipment on your boat may show itself on the display as shown in the figure below. When this occurs use the interference rejector.



Note: A high setting for interference rejection can also remove weak echoes (small targets).

1.10.1 Interference rejection for the FCV-38

1. Click the [Sounder] icon () from the InstantAccess bar™ to show the [Sounder] menu.
2. Click the [Interference] icon (). [INTERFERENCE] appears in the miscellaneous section of the header and is highlighted in a green color.

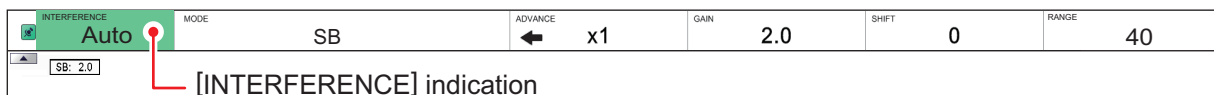



3. Scroll to adjust the level of interference rejection, referring to the table below.

Setting	Description
[Off]	Disable interference rejection.
[NL1]	Lowest level of rejection.
[NL2]	Medium level of rejection.
[NL3]	Highest level of rejection.
[Auto]	Automatically adjust the level of rejection to suit current conditions.

1. OPERATION

1.10.2 Interference rejection for external echo sounders where "External Fish Finder Window" is set to "Off" at installation

1. Click the [Advanced Settings] icon () from the InstantAccess bar™, then click the [Advanced Settings] icon () to show the [Advanced Settings] window.
2. Click the [Sounder] item from the [External Fish Finder] menu, on the left-side of the window. The external fish finder settings are shown on the right-side of the window.

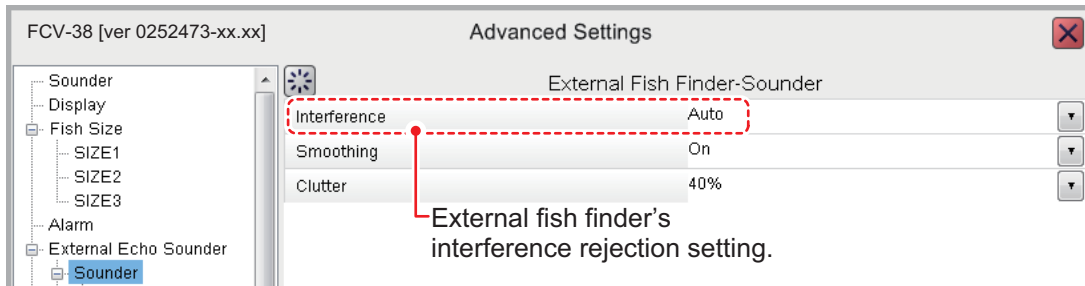

3. Click the [Interference] setting. The drop-down options box appears at the far right-side of the window.
4. Click the drop-down box, then select the appropriate interference level, referring to the table in section 1.10.1.
5. Click [Apply] to save the current changes and change or adjust other settings. Click [OK] to save the current changes and close the menu window. Click [Cancel] to abort all changes and close the menu window.



1.10.3 Interference rejection for external echo sounders where "External Fish Finder Window" is set to "On" at installation

1. Place the cursor inside the external fish finder screen, then right-click. The [External Fish Finder] menu appears.
2. The [Sounder] menu is already selected.
3. Click the [Interference] setting. The drop-down options box appears at the far right-side of the window.
4. Click the drop-down box, then select the appropriate interference level, referring to the table in section 1.10.1.
5. Click [Apply] to save the current changes and change or adjust other settings. Click [OK] to save the current changes and close the menu window. Click [Cancel] to abort all changes and close the menu window.

1.11 How to Use the Smoothing Function

The smoothing function "smooths" echo presentation when enabled. This is particularly useful when echoes appear "spotty" or "jagged". Smoothing can also be used to reduce screen flicker at night.

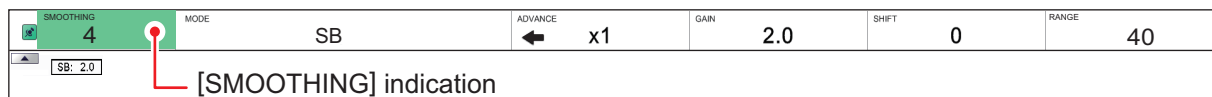

1.11.1 How to use smoothing for the FCV-38

1. Click the [Sounder] icon () from the InstantAccess bar™ to show the [Sounder] menu.
2. Click the [Smoothing] icon (). [SMOOTHING] appears in the miscellaneous section of the header and is highlighted in a green color.



3. Scroll to adjust the level of smoothing. A high value increases the amount of smoothing applied to the picture.

1.11.2 How to use smoothing for external echo sounders where "External Fish Finder Window" is set to "Off" at installation

1. Click the [Advanced Settings] icon () from the InstantAccess bar™, then click the [Advanced Settings] icon () to show the [Advanced Settings] window.
2. Click the [Sounder] item from the [External Fish Finder] menu, on the left-side of the window. The external fish finder settings are shown on the right-side of the window.
3. Click the [Smoothing] setting. The drop-down options box appears at the far right-side of the window.
4. Click the drop-down box, then select the appropriate smoothing level. A high value increases the amount of smoothing applied to the picture.
5. Click [Apply] to save the current changes and change or adjust other settings. Click [OK] to save the current changes and close the menu window. Click [Cancel] to abort all changes and close the menu window.

1. OPERATION

1.11.3 How to use smoothing for external echo sounders where "External Fish Finder Window" is set to "On" at installation



1. Place the cursor inside the external fish finder screen, then right-click. The [External Fish Finder] menu appears.
2. The [Sounder] menu is already selected.
3. Click the [Smoothing] setting. The drop-down options box appears at the far right-side of the window.
4. Click the drop-down box, then select the appropriate smoothing level. A high value increases the amount of smoothing applied to the picture.
5. Click [Apply] to save the current changes and change or adjust other settings. Click [OK] to save the current changes and close the menu window. Click [Cancel] to abort all changes and close the menu window.

1.12 How to Reject Clutter

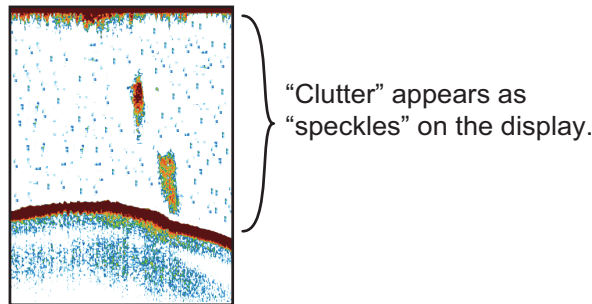
Low intensity "speckles" are referred to as clutter, and can appear over most of the screen. Clutter is often caused by sediment in the water or noise. These unwanted echoes can be rejected.



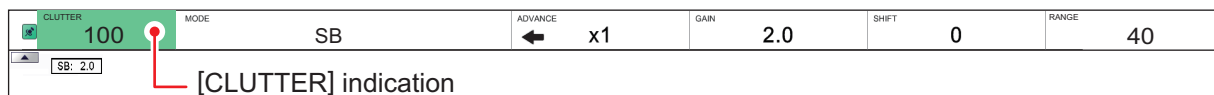

1.12.1 How to reject clutter for the FCV-38

1. Click the [Sounder] icon () from the InstantAccess bar™ to show the [Sounder] menu.
2. Click the [Clutter] icon (). [CLUTTER] appears in the miscellaneous section of the header and is highlighted in a green color.



3. Scroll to adjust the level of clutter rejection. A high value setting reduces more clutter, but can also remove weak echoes (small targets).

1.12.2 How to reject clutter for external echo sounders where "External Fish Finder Window" is set to "Off" at installation

1. Click the [Advanced Settings] icon () from the InstantAccess bar™, then click the [Advanced Settings] icon () to show the [Advanced Settings] window.
2. Click the [Sounder] item from the [External Echo Sounder] menu, on the left-side of the window. The external fish finder settings are shown on the right-side of the window.
3. Click the [Clutter] setting. The drop-down options box appears at the far right-side of the window.
4. Click the drop-down box, then select the appropriate noise reduction level. A high value setting reduces more noise, but can also remove weak echoes (small targets).
5. Select [Apply] to save the current changes and change or adjust other settings. Select [OK] to save the current changes and close the menu window. Select [Cancel] to abort all changes and close the menu window.

1.12.3 How to reject clutter for external echo sounders where "External Fish Finder Window" is set to "On" at installation

1. Place the cursor inside the external fish finder screen, then right-click. The [External Echo Sounder] menu appears.
2. The [Sounder] menu is already selected.
3. Select the [Clutter] setting. The drop-down options box appears at the far right-side of the window.
4. Click the drop-down box, then select the appropriate noise reduction level. A high value setting reduces more noise, but can also remove weak echoes (small targets).
5. Select [Apply] to save the current changes and change or adjust other settings. Select [OK] to save the current changes and close the menu window. Select [Cancel] to abort all changes and close the menu window.

1.13 Zoom Modes



The zoom modes (displays) expand the specified area of the split beam display. Four modes are available: bottom lock, bottom zoom, marker zoom and bottom discrimination. The default mode is bottom lock.

Note: A window which contains a zoomed screen can be shown (see section 4.7.8). You can freely change the size of the window by dragging and dropping the window frame. The display position can be moved by dragging and dropping the window.

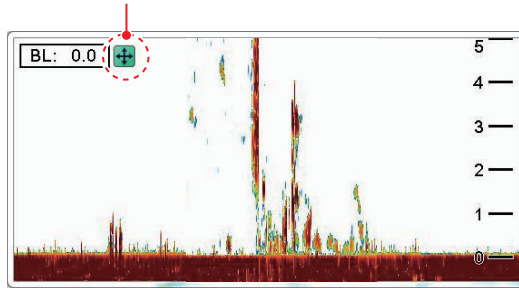
- On (green): Display size and position can be changed.
- Off: Only display size can be changed.



To select a zoom mode, do the following:

1. Select the [Sounder] icon () from the InstantAccess bar™ to show the [Sounder] menu.
2. Select the [Zoom] mode icon (). [ZOOM MODE] appears in the miscellaneous section of the header.

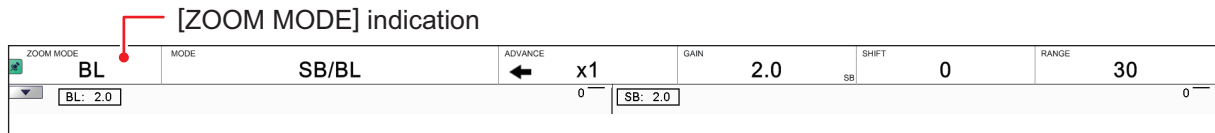

3. Scroll to show the desired zoom mode. The four modes are shown in abbreviations.
 - BL: Bottom Lock
 - BZ: Bottom Zoom
 - MZ: Marker Zoom
 - BD: Bottom Discrimination

1.13.1 Bottom lock mode

Bottom lock display provides a normal picture on the right-side of the screen and a magnified picture on the left-side of the screen. The zoomed area shows a smooth seabed, making it easier to detect fish near the seabed.

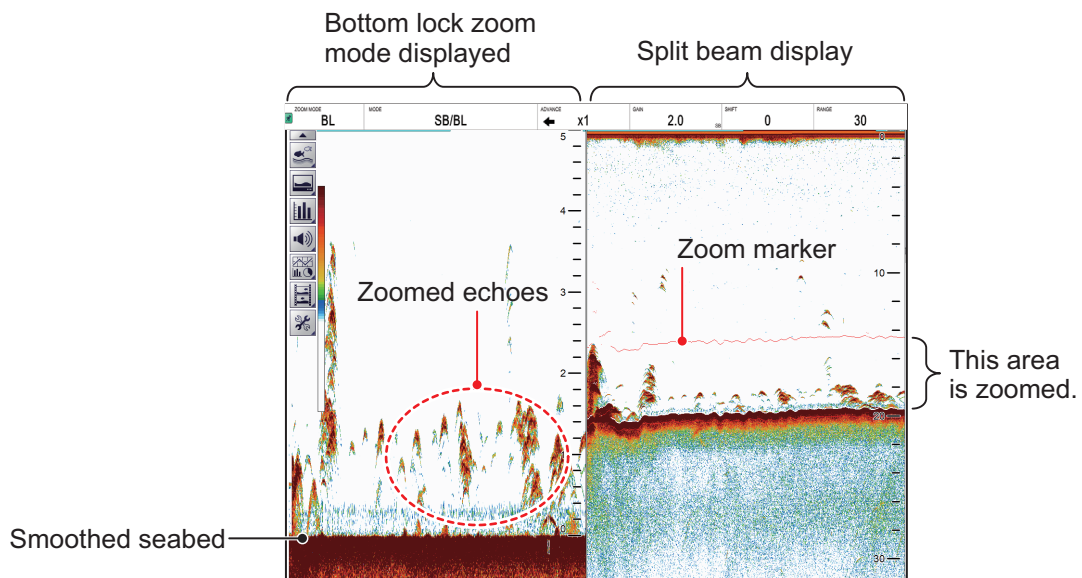

Note 1: The range for the zoom display can be adjusted from the [Range] menu. See section 4.7.1.

Note 2: To show or hide the zoom marker, change the setting for [Zoom Marker] in the [Display] menu. See section 4.3.

1. OPERATION

1.13.2 Bottom zoom mode

This mode magnifies the seabed, and also any fish near the seabed, on the left-side of the screen, and is useful for determining seabed contours. When the seabed depth increases, the display automatically shifts to keep the seabed echo at the lower part of the screen.

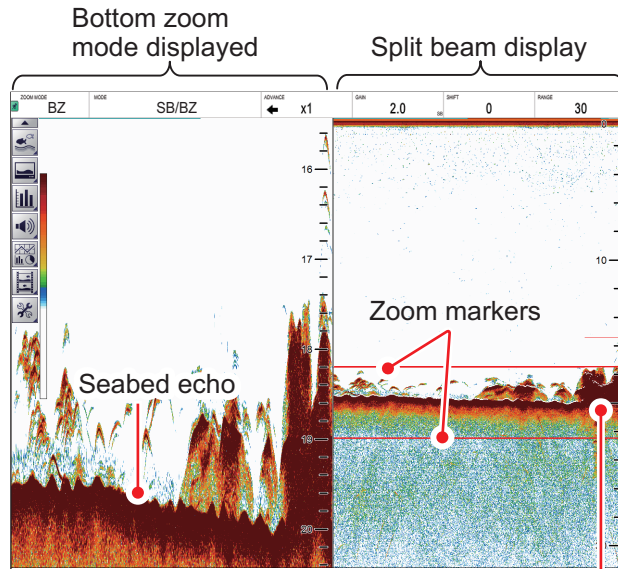

Zoom area automatically follows the seabed when the depth changes.

1.13.3 Marker zoom mode

The marker zoom mode magnifies the specified area of the normal picture to full vertical size of the screen on the left-side of the screen. You may specify the portion to expand by operating the horizontal VRM (Variable Range Marker). The area between the VRM and zoom marker is expanded. This mode is useful for determining the size of fish in the midwater.

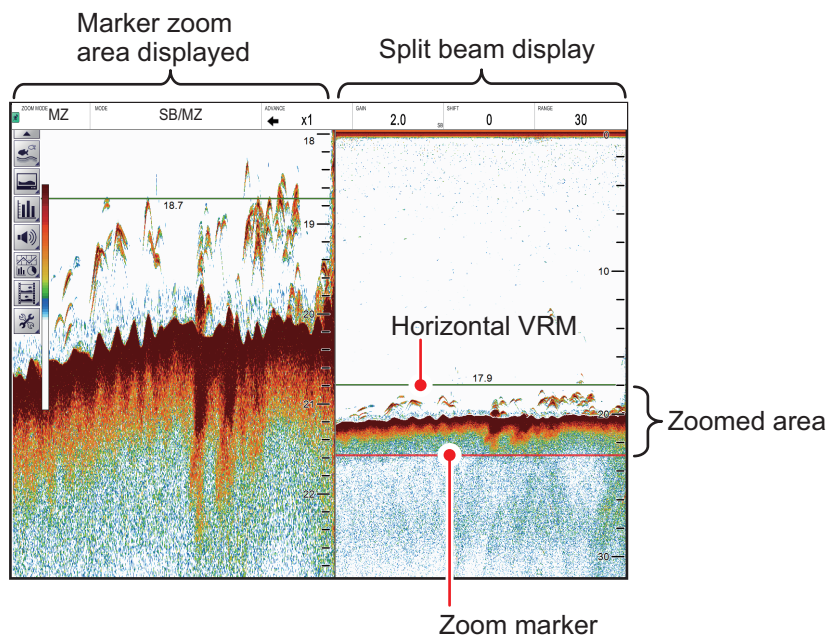

1.13.4 Bottom discrimination mode

Bottom discrimination mode has two zoom ratios which can be set from the [Range] section of the [System] menu. See section 4.7.1.

Bottom discrimination at 1/2 ratio

The left-side of the screen show the seabed as a straight line at approximately the middle of the screen.

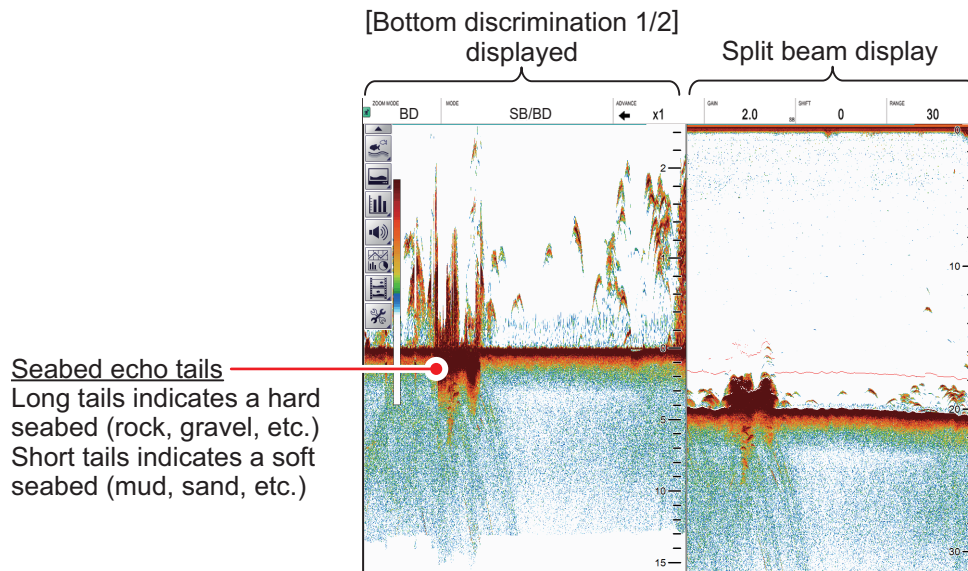

Bottom discrimination at 1/3 ratio



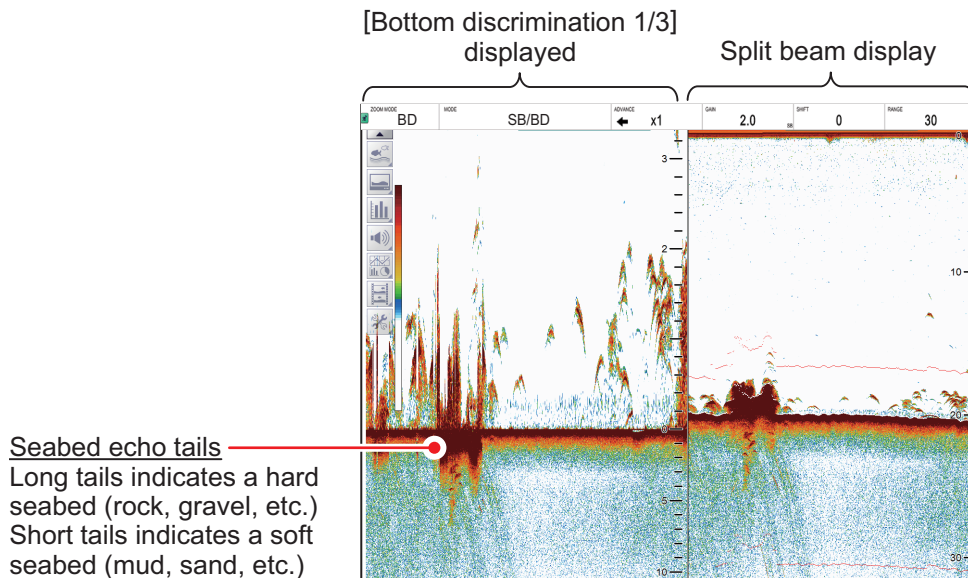

The left-side of the screen show the seabed as a straight line at approximately one third of the screen-length from the screen bottom.



1.14 How to Switch Between Daytime and Nighttime Color Modes

To assist on-screen visibility, the system has a Day display color mode and a Night display color mode. The modes can be changed at any time from the InstantAccess bar™ to suit your needs.

Unless otherwise specified, all example figures in this manual use the Day display mode.

1. Select the [Display] icon () from the InstantAccess bar™ to show the [Display] menu bar.
2. Select the [Window Color] icon () to show menu options.
3. Select [Day] () or [Night] () as appropriate. Icon and text color are reversed, as shown in the example figures below.

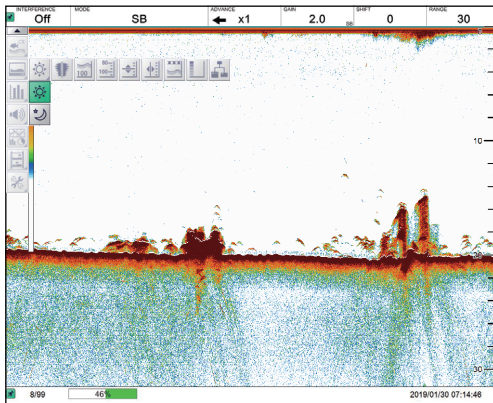

Day mode

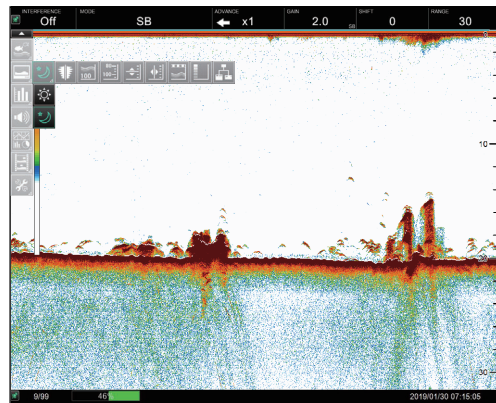



Night mode

4. Select the [Display] () icon to hide the menu bar.

1.15 How to Use the A-scope Display

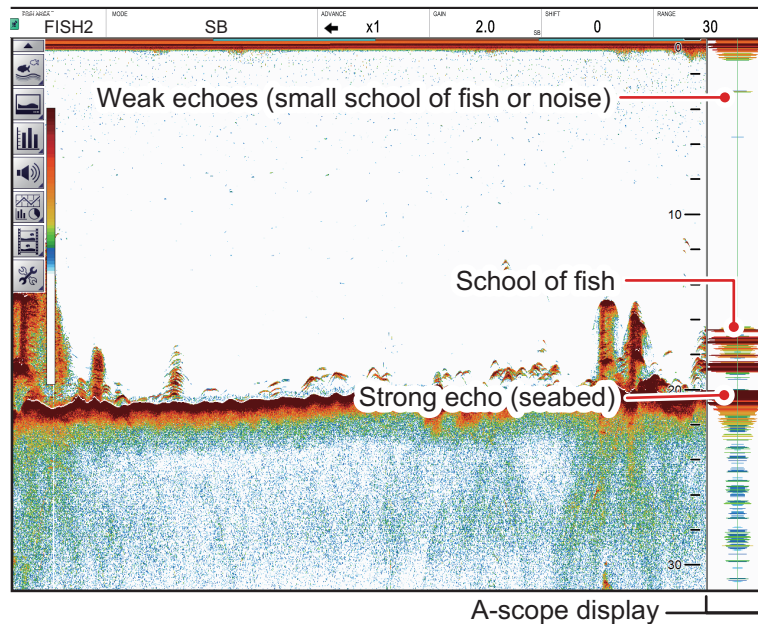
The A-scope display shows echoes at each transmission with amplitudes and tone proportional to their intensities, on the right side of the screen. It is useful for estimating the species of a school of fish or determining bottom composition.



To show or hide the A-Scope display, select the [A-Scope] icon () from the [Display] menu, on the InstantAccess bar™. The icon changes to green color when shown.

1.16 How To Show/Hide The Depth Indication

The current depth indication appears at the bottom-left of the screen. You can show or hide the depth indication to suit your preferences.

To show/hide the depth indication, select the [Depth] icon () from the [Display] menu on the InstantAccess bar™. The icon changes to green color when shown.

1.17 How To Show/Hide The Depth Scale

The depth scale is displayed to the far right-hand side of the screen.



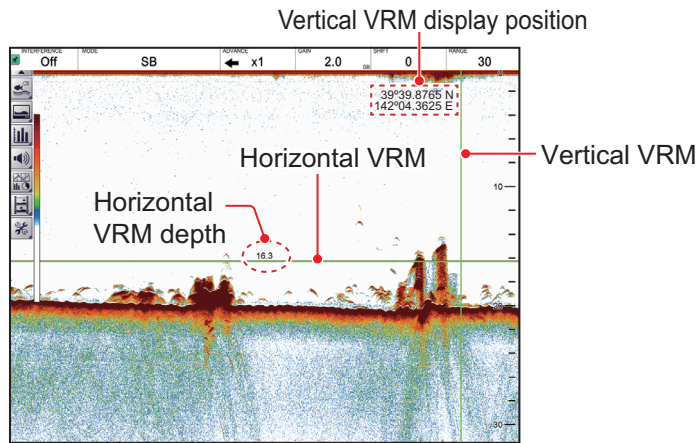

To show/hide the depth scale, select the [Depth Scale] icon () from the [Display] menu on the InstantAccess bar™. The icon changes to green color when shown.

1.18 How to Measure Depth and Position of a School of Fish

You may measure the depth to a school of fish or bottom with the horizontal VRM (Variable Range Marker). Further, you may find the position of the school with the vertical VRM.







How to measure depth

1. Select the [Display] icon () from the InstantAccess bar™ to show the [Display] menu, then select the horizontal VRM icon (). The icon is now highlighted in green color and the VRM appears on the display.
2. Drag and drop the VRM so that it intersects the echo who's depth you want to measure.
3. The depth is displayed above (or below) the VRM, at the center of the VRM.
4. To hide the horizontal VRM, select the [Display] icon () from the InstantAccess bar™, then select the horizontal VRM icon ().

How to measure position

Note: This feature requires position data from a EPFS. If position data is lost, position information is not shown.

1. Select the [Display] icon () from the InstantAccess bar™ to show the [Display] menu, then select the vertical VRM icon (). The [VRM] icon is now highlighted in green color and the VRM appears on the display.
2. Drag and drop the VRM so that it touches the school of fish for which you want to know its position. The position is displayed to the left of the VRM. To hide the VRM, repeat steps 1 and 2, in order.
3. Read the latitude and longitude position shown on the VRM.
4. To hide the vertical VRM, select the [Display] icon () from the InstantAccess bar™, then select the vertical VRM icon ().

1.19 How To Show/Hide The Minute Marker

The Minute Marker appears at the top of the screen when displayed. It is displayed as a dashed line, with each dash, and gap between dashes, indicating a 30 second period of time. In other words, the time from the start of one dash to the start of the next dash is one minute.

To show/hide the time interval line, select the [Minute Marker] icon () from the Display menu on the InstantAccess bar™. The icon changes to green color when shown.

1

1.20 How To Show/Hide The Color Bar

The color bar shows the echo color scale in use, with the strongest echo color at the top of the scale and weakest echo color at the bottom.



To show/hide the color bar, select the [Color Bar] icon () from the Display menu on the InstantAccess bar™. The icon changes to green color when shown.

1.21 External Fish Finder Window

By connecting two monitors and an external fish finder and setting the equipment (at installation) as shown in the table below, the images from the external fish finder are displayed on the sub monitor.

Menu item	Setting
[Sub Monitor Display Switching]	[Dual]
[External Fish Finder Window]	[On]

When the setting for [External Fish Finder Window] is [Off], the sub monitor shows the FCV-38 logo.

To show the external fish finder echoes on the sub display, Select the [Display] icon () from InstantAccess bar™, then select the [External Echo Sounder] icon ().



Main monitor: Echoes from FCV-38 fish finder displayed.

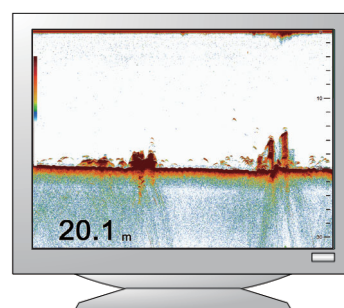

Sub monitor: Echoes from external fish finder displayed.

1. OPERATION

Note: When the external fish finder display is active, settings, changes and adjustments made to the FCV-38 display are not reflected on the external display (with the exception of language and units of measurement). Settings, changes and adjustments for the external fish finder must be done from the sub monitor. Place the cursor inside the external fish finder screen, then right-click to display the external fish finder menu. See section 4.8.

1.21.1 How to change the display mode

You can change the display mode on an external monitor by doing the following:

1. Place the cursor inside the external fish finder display, then right-click to show the [External Fish Finder] menu.
2. Select [Display].

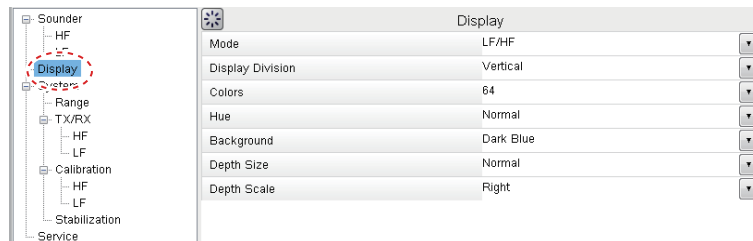

3. Select the drop-down icon for the [Mode] setting, on the right-side of the menu. The drop-down options appear, where you can select an appropriate option.
[LF/HF] : High and low frequency images.
[HF] : High frequency images only.
[LF] : Low frequency images only.
4. If you select [LF] or [HF] at step 3, go to the step 5.
If you selected [HF/LF] at step 3, set the screen division from the [Display Division] menu item, directly below the Mode menu item.
5. Select [Apply] to apply the changes and delete or edit a different mode. Select [OK] to apply the changes and close the menu. Select [Cancel] to cancel any changes made and close the menu.

1.21.2 How to use the ACCU-FISH™ feature

The ACCU-FISH™ feature requires connection to a compatible transducer (50/200-1T).

The ACCU-FISH™ feature outputs fish echoes with a mark and an estimated size.

Important considerations when using the ACCU-FISH™ feature

- The ACCU-FISH™ feature is intended for reference purposes; it is not a completely accurate measurement of fish length.
- Echo intensity depends on fish species. When the fish length differs between the indicated length and the actual length, you can compensate the difference on the [Calibration] menu. See section 4.8.4.
- Fish at depths of less than two meters cannot be measured. However, if [Zero Line Rejector] is set to [On], fish within the area covered by the transmission line cannot be detected.

- The maximum depth at which the ACCU-FISH™ feature can detect fish varies, depending on transducer type, vessel configuration, sea conditions and other factors which may affect beam accuracy.
- In a school of fish, the echoes overlap. This causes a greater margin of error in fish size measurement.
- This feature cannot be used with inside-hull transducers. Depending on the transducer frequency, fish may not be detected. Further, even if fish are detected, their indicated length may be smaller than the actual length.
- The TX pulse length changes according to ACCU-FISH™ On/Off state. This causes a difference in both sensitivity and the echoes viewed.

How to activate/deactivate the ACCU-FISH™ feature

1. Place the cursor inside the external fish finder screen, then right-click to show the [External Fish Finder] menu.
2. Select [Measurement]. The ACCU-FISH™ setting appears in the right-side of the window.

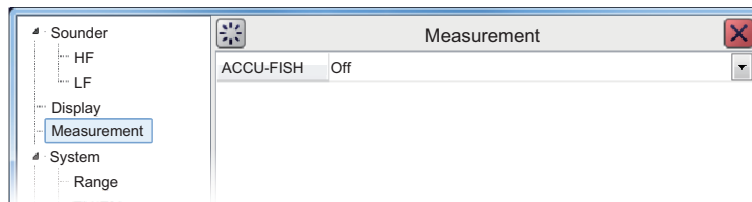

3. Click the drop-down box to the far right-hand side of the menu, then select [On]. ACCU-FISH™ is now active, fish marks and sizes now appear on the screen.

Fish size — 64  Fish mark

4. To deactivate ACCU-FISH™, repeat the procedure, then select [Off] at step 3.

1.22 How to Set, Show and Hide Alarms

The FCV-38 has five alarms, Bottom Alarm, Fish Alarm, Bottom Fish Alarm, Temperature Alarm, and Fish Size Alarm.

When an alarm is set and the conditions meet the alarm requirements, the system releases an audible beep and the applicable alarm icon appears at the bottom-right corner.



: Bottom Alarm icon



: Bottom Fish Alarm icon



: Fish Size Alarm icon



: Fish Alarm icon



: Temperature Alarm icon

To silence the audible beep, click anywhere on the screen. The alarm icon remains visible on the display until the cause of the alarm is removed.

Alarm descriptions

- **Bottom Alarm:** Alerts you when the seabed (bottom) enters the range set for this alarm.
- **Fish Alarm:** Alerts you when fish are detected within the range set for this alarm.
- **Bottom Fish Alarm:** Alerts you when fish are detected within the range set for this alarm.
- **Temperature Alarm:** Alerts you when the water temperature is within range or out of range, depending on your selection. This alarm requires water temperature data.
- **Fish Size Alarm:** Alerts you when the fish size of selected fish meets the 1st peak on the fish size graph bar and/or when the distribution of 1st peak on the fish size graph bar meets or exceeds the value set. The fish size graph must be active to use this alarm.

1.22.1 How to activate/deactivate the alarms

You can activate and deactivate alarms by selecting the respective alarm icon.

To activate or deactivate an alarm, do the following:

1. Select the Alarm icon (🔊) from the InstantAccess bar™ to show the [Alarm] menu.
2. Referring to the figure below, select the alarm you want to activate or deactivate. The icon changes color depending on whether the status selected.

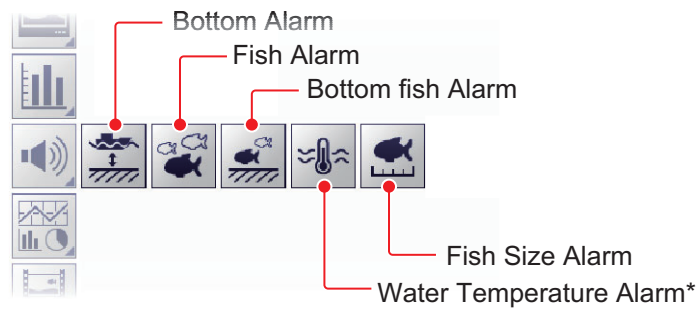

*: Requires water temperature data.

A green icon indicates an active alarm; grey icon means an alarm is disabled. The Bottom Alarm, Bottom Fish Alarm and Fish Alarm also show an "alarm marker" on the right-side of the echo display, and the marker shows the alarm range.

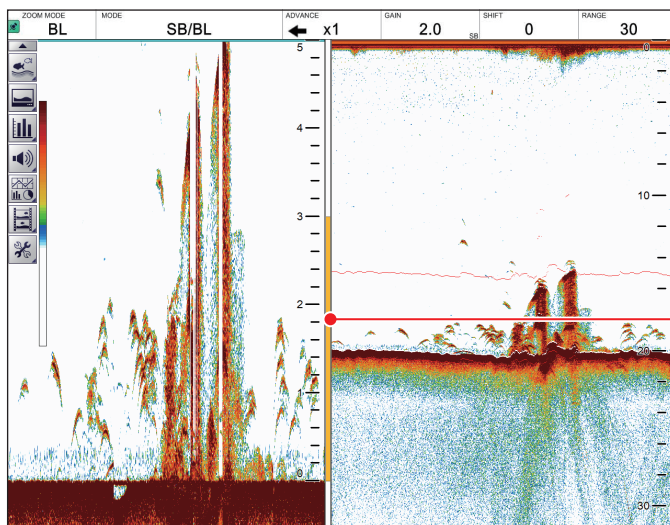



Alarm markers, displayed in the following colors:
 Bottom Alarm: Green
 Fish Alarm: Orange
 Bottom Fish Alarm: Orange.
 Appears at the right-hand side of the Bottom Lock or Bottom Discrim Zoom (window).

1. OPERATION

1.22.2 How to set the alarms

The FCV-38 has five alarms. To set the conditions for each alarm, do the following:

1. Select the [Advanced Settings] icon () from the InstantAccess bar™, then select the [Advanced Settings] icon () to show the [Advanced Settings] window.
2. Select the [Alarm] item on the left-hand side of the window to show the [Alarm] menu (right-side of the window).

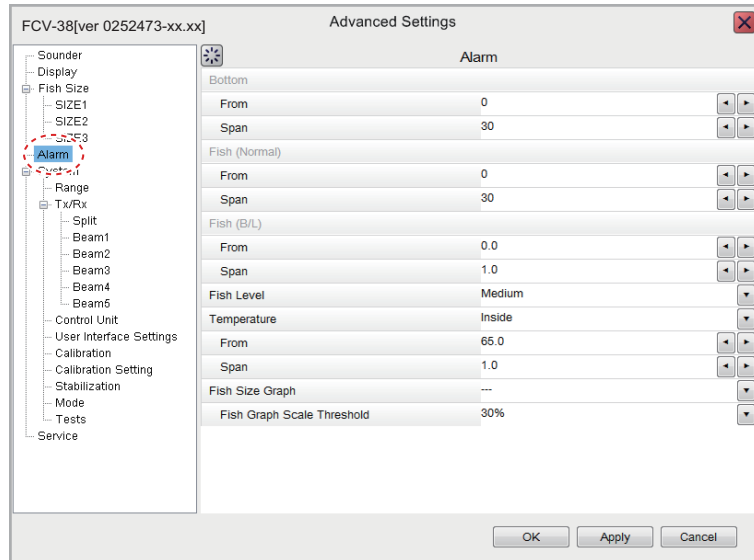

3. Referring to the table below, set the alarms as required.

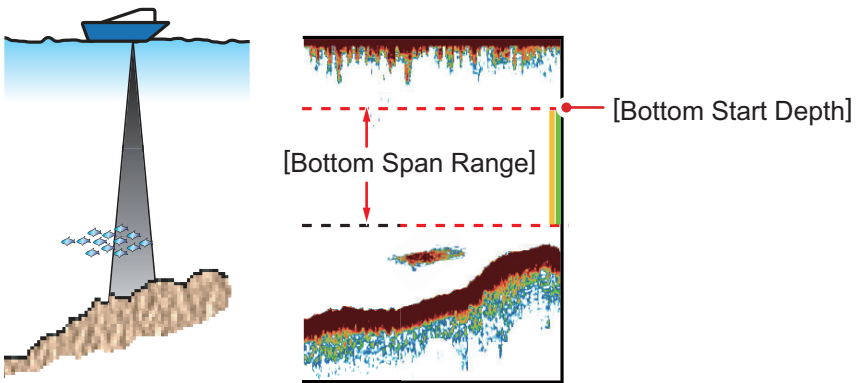
Menu item	Description
[Bottom]	<p>Sets the bottom starting depth ([From]) and bottom span range [Span] for the depth alarm. The distance set here is measured from the location of the transducer face.</p> 
[Fish (Normal)]	<p>Sets the starting depth ([From]) and span range [Span] for the fish alarm. The distance set here is measured from the location of the transducer face.</p>
[Fish (B/L)]	<p>Sets the starting depth ([From]) and span range [Span] for the bottom fish alarm. The distance set here is measured from the location of the transducer face.</p>
[Fish Level]	<p>Sets the echo strength at which the fish alarms are triggered. This setting is for both the [Fish Alarm] and the [Bottom Fish Alarm].</p> <ul style="list-style-type: none"> • [Weak]: Echoes stronger than light blue trigger the alarm. • [Medium]: Echoes stronger than yellow trigger the alarm. • [Strong]: Echoes stronger than red trigger the alarm.

Menu item	Description
[Temperature]*	<p>[Temperature]: Set the water temperature alarm type.</p> <ul style="list-style-type: none"> • [Inside]: Audiovisual alarm is released when the temperature is within the alarm range setting. • [Outside]: Audiovisual alarm is released when the temperature is outside the alarm range setting. <p>[From]: Set the starting temperature for the alarm. [Span]: Set the span of the alarm.</p>
[Fish Size Graph]	<p>[Fish Size Graph]: Sets the fish size(s) which trigger the Fish Size Graph Alarm. Multiple selections are available.</p> <p>[Fish Graph Scale Threshold]: Set the distribution rate at which to trigger the alarm. For example, a setting of [30%] will trigger the alarm when the distribution rate for the selected size is over 30% and the selected graph bar is "1st peak".</p>

*: Requires water temperature data.

4. Select [Apply] to save the current changes and change or adjust other settings.
Select [OK] to save the current changes and close the menu window.
Select [Cancel] to abort all changes and close the menu window.

1.23 How To Show/Hide Navigation Data

Various navigation data can be shown at the top-left corner*.

- | | |
|-----------------------------------|---|
| • Latitude and longitude position | • Roll, pitch, heave |
| • Time and date | • Water temperature |
| • SOG | • Timer (elapsed time from input of marker) |
| • STW | |

* The location of the navigation data can be changed. See "[Data Position]" on page 4-5 for details.

To show/hide the navigation data, select the [Data Display] icon (📊) from the InstantAccess bar™, then, referring to the figure below, select the data to show or hide.

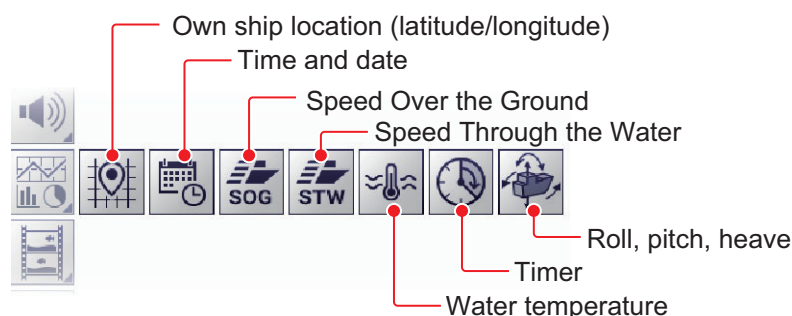

1.24 How to Inscribe TLL Lines

You can inscribe TLL (Target Latitude Longitude) lines on the display to mark the location of schools of fish, shoals, or other points of interest. The position of each TLL is output to the connected chart plotter.

Note 1: The position output function requires connection to an external EPFS device which provides own ship position data.

Note 2: Data other than latitude and longitude can be output to connected chart plotters. See section 6.7.2.

Note 3: If the [Timer] function (icon: ) is on (see section 1.24) the elapsed time (max. 99 min. 59 sec.) can be shown by double clicking the display,

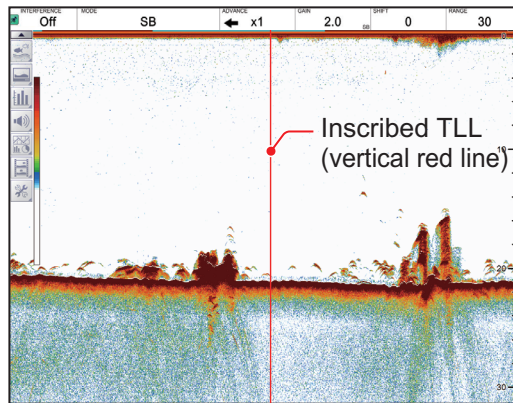





To inscribe a TLL line, place the cursor on the display location to be inscribed, then double-click. A vertical line, red in color, appears at the location. The TLL moves with the inscribed location. You can inscribe multiple lines at any time.

Under default settings, the FCV-38 also outputs the TLL to the connected chart plotter.

1.25 How to Use the Scroll Back Mode

Scroll back mode allows the user to view past screens of fish finder images, making it handy for comparing the sizes of schools of fish close to each other.

To start the scroll back mode, use the right button to drag and drop in the rightward direction. When the scroll back mode is active, the “scroll back release” button (Day mode: , Night mode: ) appears at the top-right corner.

To release the scroll back mode, click the “scroll back release” button (Day mode: , Night mode: )

Note: All echoes stop when the scroll back mode is activated. Use caution with this feature and avoid use when the vessel is underway.

1.26 How to Erase Weak Echoes

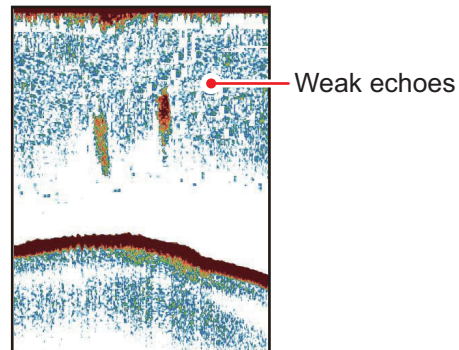

Sediment in the water or reflections from plankton may be painted on the display in low intensity tones, as shown in the illustration below. You can remove these unwanted echoes with the color erase feature.



1

1.26.1 How to erase weak echoes for the FCV-38 and external echo sounders

Where [External Fish Finder Window] is set to [Off] at installation, this setting is applied to the external fish finder also.

1. Select the [Advanced Settings] icon () from the InstantAccess bar™ to show the [Advanced Settings] menu.
2. Select the [Advanced Settings] icon () from the [Advanced Settings] menu. The [Advanced Settings] window appears.

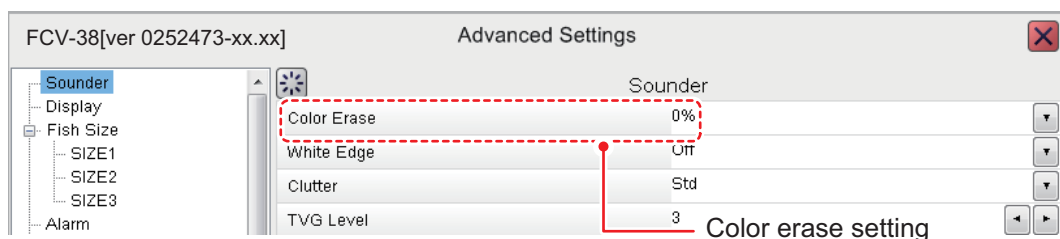

3. The [Sounder] menu item is already selected and the [Sounder] menu appears on the right-side of the window. Select [Color Erase] from the [Sounder] menu.
4. Adjust the [Color Erase] setting until the picture shows minimal reflections. As the setting increases, reflections are removed in order, from weakest to strongest.
5. Select [Apply] to save the current changes and change or adjust other settings. Select [OK] to save the current changes and close the menu window. Select [Cancel] to abort all changes and close the menu window.

1.26.2 How to erase weak echoes for external echo sounders where "External Fish Finder Window" is set to "On" at installation

1. Place the cursor inside the external fish finder screen, then right-click to show the [External Fish Finder] menu.
2. The [Sounder] menu is already selected.
3. Select the [Color Erase] setting. The drop-down options box appears at the far right-side of the window.
4. Click the drop-down box, then select the appropriate color erasure level. As the setting increases, reflections are removed in order, from weakest to strongest.
5. Click [Apply] to save the current changes and change or adjust other settings. Click [OK] to save the current changes and close the menu window. Click [Cancel] to abort all changes and close the menu window.





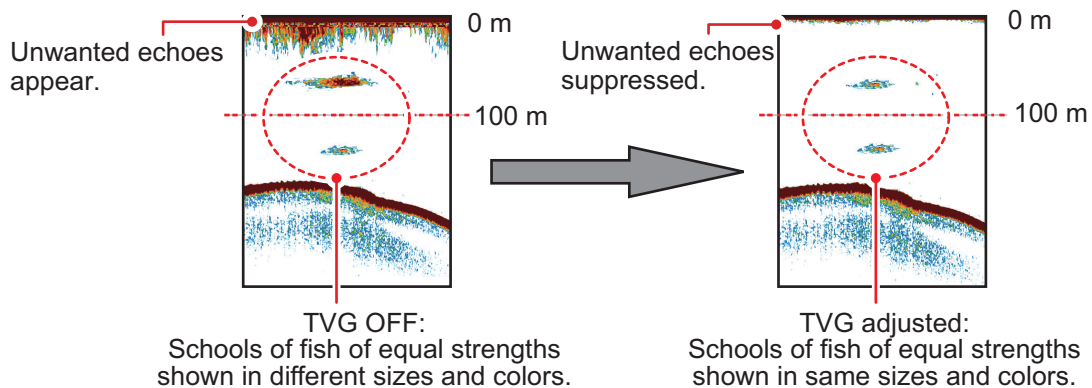

1.27 How to Adjust TVG (Time Varied Gain)

A school of fish at a deep depth is displayed in weak colors even if it is equal in strength to one in shallow waters. This is due to propagation attenuation of the ultrasonic wave. To compensate for this difference, use TVG. TVG automatically adjusts the gain with depth so that echoes of the same strength and different depths are shown in the same colors regardless of their depths. The gain is increased with depth to display echoes of equal strengths in the same colors. In the figure below, for example, the TVG is set for 100 m and the TVG level is adjusted. Then, unwanted echoes at a distance less than 100 m are deleted and echoes at depths greater than 100 m are not affected.





1.27.1 How to adjust TVG for FCV-38

The procedure outlined below is for sounders connected directly to the FCV-38. For external fish finder, see section 1.27.2.

1. Click the [Advanced Settings] icon () from the InstantAccess bar™, then click the [Advanced Settings] icon () to show the [Advanced Settings] window.
2. Click [Sounder].
3. Click the adjust buttons ( ) for [TVG Level] to set the TVG level. The larger the digit, the greater the TVG effect.
4. Click the adjust buttons ( ) for [TVG Distance] to set the TVG distance.
5. Click [OK] to save the current changes and close the menu window.

1.27.2 How to adjust TVG for external echo sounders where "External Fish Finder Window" is set to "Off" at installation



1. Click the [Advanced Settings] icon () from the InstantAccess bar™, then click the [Advanced Settings] icon () to show the [Advanced Settings] window.
2. Click [HF] or [LF], as appropriate, from the [Sounder] item from the [External Fish Finder] menu, on the left-side of the window. The external fish finder settings are shown on the right-side of the window.



HF menu



LF menu

3. Click the [TVG Level] adjust buttons ( ) as appropriate. Select a larger figure to increase TVG, or a smaller figure to decrease TVG.
4. Click [OK] to save the current changes and close the menu window. Click [Cancel] to abort all changes and close the menu window.

1.27.3 How to adjust TVG for external echo sounders where "External Fish Finder Window" is set to "On" at installation

1. Place the cursor inside the external fish finder screen, then right-click. The [External Fish Finder] menu appears.
2. The [Sounder] menu is already selected.
3. Select the frequency for the sounder you want to adjust. [HF] for high frequency, [LF] for low frequency. The settings for the selected frequency appear on the right-side of the window.
4. Click the [TVG Level] adjust buttons (◀▶) as appropriate. Select a larger figure to increase TVG, or a smaller figure to decrease TVG.
5. Click [OK] to save the current changes and close the menu window. Click [Cancel] to abort all changes and close the menu window.

1.28 How to Save and Load Settings

Settings can be stored to, or loaded from, either the FCV-38 internal memory or an external storage device.

1.28.1 How to save settings

The internal memory can store up to 8 settings variations. For external memory, the maximum number of settings variations which can be stored depends on the external memory's available capacity.

Note: Settings which have been over-written (saved over) cannot be restored. Always check that the save location is correct before starting the save procedure.

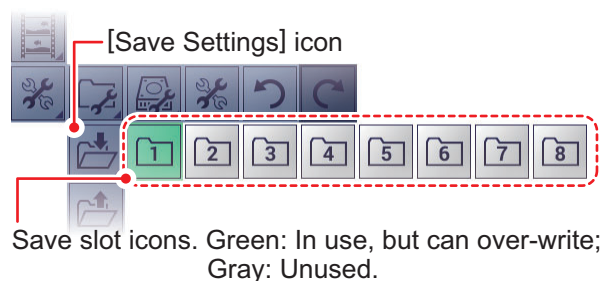

How to save settings to internal memory

1. Click the [Advanced Settings] icon (⚙️) from the InstantAccess bar™, then click the [Advanced Settings] icon (⚙️) to show the [Advanced Settings] window.
2. Click the Internal Setting icon (📁) to show the internal setting save/load icons.
3. Click the Save Settings icon (💾) to show the save slot icons.



4. Select the save slot you want to use. A confirmation message pop-up appears after the save process is complete.
5. Click [OK] to close the pop-up.

How to save settings to external memory



1. Click the [Advanced Settings] icon () from the InstantAccess bar™ to show the [Advanced Settings] menu, then click the [External Setting] icon () to show the external setting save/load icons.
2. Click the [Save External Unit Settings] icon (). A confirmation message pop-up appears after the save process is complete.
Note: If there is no external memory connected, the [Save External Unit Settings] icon is gray and not selectable.
3. Click [OK] to close the pop-up.

1.28.2 How to load settings

Previously saved settings can be loaded from their save location, either internal or external location, at any time.

Note: When the load procedure is complete, previous settings cannot be restored. Check that the settings to be loaded are correct before starting the procedure.

How to load settings from internal memory

1. Click the [Advanced Settings] icon () from the InstantAccess bar™ to show the [Advanced Settings] menu, then click the [Internal Setting] icon () to show the internal setting save/load icons.
2. Click the [Load Settings] icon () to show the load slot icons.

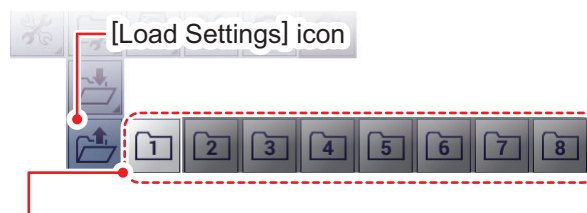



Load slot icons. Light-gray: Available to load from.
Dark-gray: No data saved.

3. Select the load slot you want to use. The system applies the loaded settings.

How to load settings from external memory

Note: This method requires connection to an external memory device. If there is no device connected, the [Load External Unit Settings] icon shown in the procedure below are not available.

1. Click the [Advanced Settings] icon () from the InstantAccess bar™ to show the [Advanced Settings] menu, then click the [External Setting] icon () to show the external setting save/load icons.
2. Click the [Load External Unit Settings] icon (). A pop-up window listing the available settings files appears.
3. Select the settings file to load.
4. Click [OK] to close the pop-up.

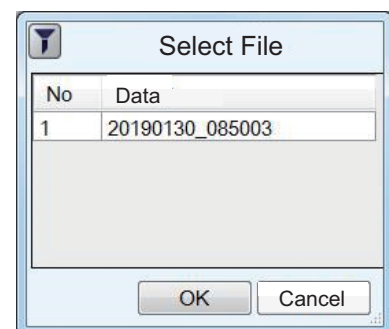

1.29 How to Undo/Redo Operations



The system stores the last 20 operations in temporary memory. This allows you to "undo" a mistaken operation, or several mistaken operations, at any time. You can also "redo" an operation which was undone.

Note 1: Operations done before turning off the power can not be undone or redone.

Note 2: When the following operations are done, the history contents of the last-done undo/redo is deleted.

- Start/stop echo data recording
- Playback/stop recorded echo data
- Loaded settings

How to undo an operation

1. Click the [Advanced Settings] icon () from the InstantAccess bar™ to show the [Advanced Settings] menu.
2. Click the [Undo] icon () to undo the last operation.
3. Repeat step 2 as required.

How to redo an operation

1. Click the [Advanced Settings] icon from the InstantAccess bar™ to show the [Advanced Settings] menu.
2. Click the [Redo] icon () to redo the last operation.
3. Repeat step 2 as required.

2. GRAPH FUNCTIONS

The FCV-38 can display up to five graphs (listed in section 2.1, below), depending on vessel configuration.







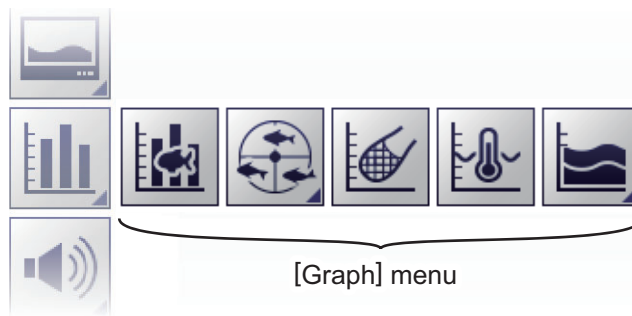

2.1 How to Show/Hide Graphs

All graphs can be shown/hidden to suit your requirements. To show/hide a graph, do the following:

1. Click the [Graph] icon () from the InstantAccess bar™ to show the [Graph] menu.



2. Select the appropriate graph to show/hide. The icon changes color accordingly, green for shown, gray for hidden.

Icon	Description
	[Fish Size Graph]: Shows/hides a bar graph which displays estimated fish size and related data. The fish size graph shows the size and distribution of fish within the measuring range. See section 2.2.
	[Target Position]: There are two types of target position graphs, horizontal target position graph, and vertical target position graph.
	 [Vertical Graph]: Shows/hides the vertical graph. The vertical target position graph displays detected position of the school of fish within a circle centered on the ship. See section 2.3.1.
	 [Horizontal Graph]: Shows/hides the horizontal graph. The horizontal target position graph displays the position of the school of fish with the view from the stern direction. See section 2.3.2.
	[Sonde Graph]: Shows/hides a plotted graph which displays depth and water temperature data fed from the net sonde. See section 2.4.
	[Temp Graph]: Shows/hides a plotted graph which displays the water temperature as a dotted line across the screen. See section 2.5.
	[Bottom Information Graph]: There are two types of bottom information graphs, hardness graph, and roughness graph.
	 [Hardness Graph]: Shows/hides the hardness graph. The hardness graph displays the hardness of the seabed, in graph form, derived from the reflection intensity of the bottom echo. See section 2.6.1.
	 [Roughness Graph]: Shows/hides the roughness graph. The roughness graph displays the roughness of the seabed surface, in graph form. See section 2.6.2.

2.2 Fish Size Graph

The [Fish Size Graph] displays the fish size and distribution in a bar graph format. (A horizontal bar graph is also available.)

In the following example, fish size (in centimeters) is shown from left to right and the distribution (as a percentage) is shown from bottom to top.

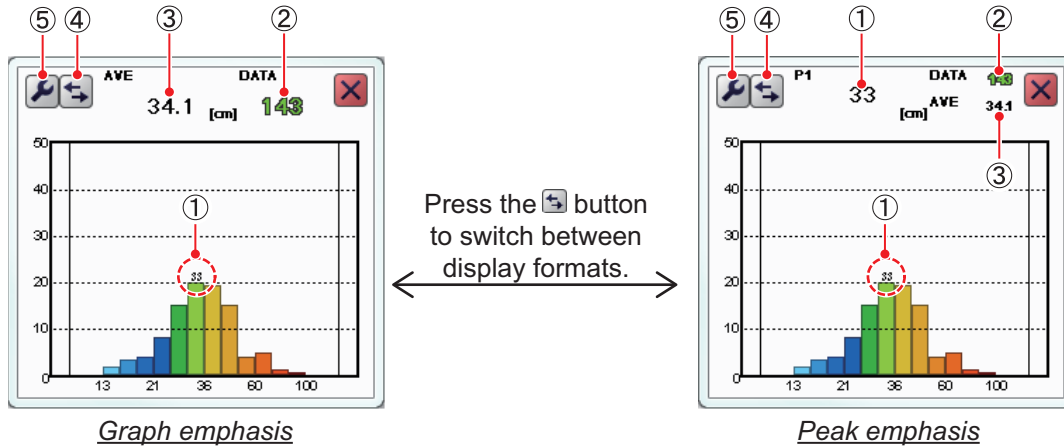

No.	Description
1	Estimated size of the largest fish detected (peak size) detected. Depending on the setting selected for [SIZE1] - [SIZE3] on the [Fish Size] menu, you can display the peak value for third largest fish. See section 2.2.7. Note: When peak emphasis is selected, only P1 is displayed at the top of the window regardless of the [Graph Peak] setting.
2	Total number of fish detected.
3	Overall average size of fish detected.
4	[Switch Display] button. Select to switch between graph emphasis and peak emphasis display formats.
5	[Advanced Settings] button. Click to access the [SIZE1] - [SIZE3] menus. See section 2.2.7.

The [Fish Sizes Graph] can be moved or resized as appropriate. Drag the window edge to change size; drag and drop the window to change location.



Notices regarding the fish size graph

- The strength of a school of fish changes with species. If the displayed value is different from the actual one, you can compensate for the difference. See [Offset] in section 2.2.7.
- Use the feature where the depth is 2 meters or more. Further, the measurement area and installation can affect detection.
- Echoes can overlap in a school of fish. This causes a greater margin of error in fish size measurement.
- Fish size data is displayed in one of three colors, based on the reliability of the sensor data. The colors and their meaning are listed in the table below.

Color	Meaning
Green	Data is reliable, fish size is mostly accurate.
Yellow	Data is not totally reliable, fish size is somewhat accurate.
Red	Data is not reliable, fish size accuracy is very low.

2.2.1 How to show/hide the fish size graph

To show/hide the graph do the following:

1. Click the [Graph] icon () from the InstantAccess bar™ to show the [Graph] menu.
2. Click the [Vertical Target Graph] icon (). The icon changes to a green color and the [Vertical Target Graph] appears.



To close the graph, click the [Close Window] icon () , or click the graph icon.

2.2.2 How to set the method of measurement

The FCV-38 has the four methods of fish size measurement described below. The measurement range is displayed on the split beam screen.

- [Entire Area]: Measures the size of individual fish over the entire measuring area. See section 2.2.3.
- [Specific Range]: Measure the size of individual fish within the specified depth range. See section 2.2.4.
- [Bottom Trace]: Measure the size of individual fish near the seabed. See section 2.2.5.
- [Specific Area]: Measure the size of individual fish within the specified area. See section 2.2.6.

To select, or change, the method of measurement, do the following:

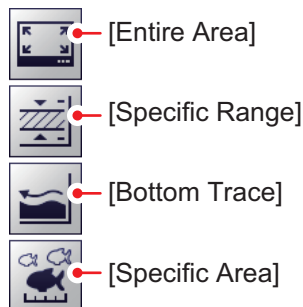

1. Click the [Sounder] icon () from the InstantAccess bar™ to show the [Sounder] menu bar.
2. Click the [Fish Size Measurement] icon () to show menu options.



3. Select the appropriate method of measurement icon, referring to the figure above.

2.2.3 Entire area

This method measures all detected fish. When this method is active, the area of detection (the entire screen) is surrounded with a yellow frame, as shown in the example figure below.

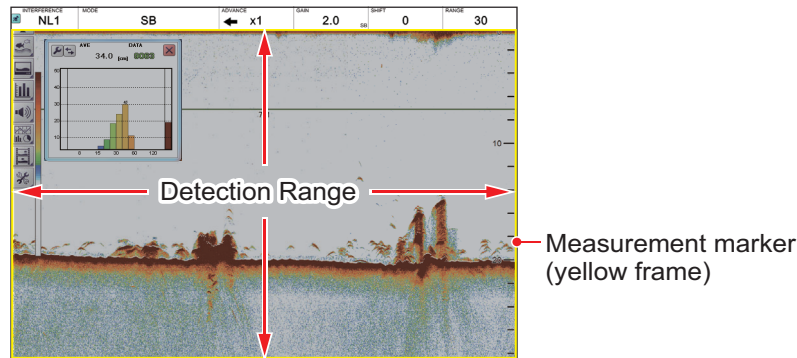

1. Switch to a display that includes the split beam display ([MODE] indication: [SB]).
2. Click the [Sounder] icon () from the InstantAccess bar™ to show the [Sounder] menu bar, then click the [Fish Size Measurement] icon () to show menu options.
3. Click the [Entire Area] icon () .

2. GRAPH FUNCTIONS



2.2.4 Specific range

This method produces three marker lines, one vertical and two horizontal, which can be adjusted to set the specified range.

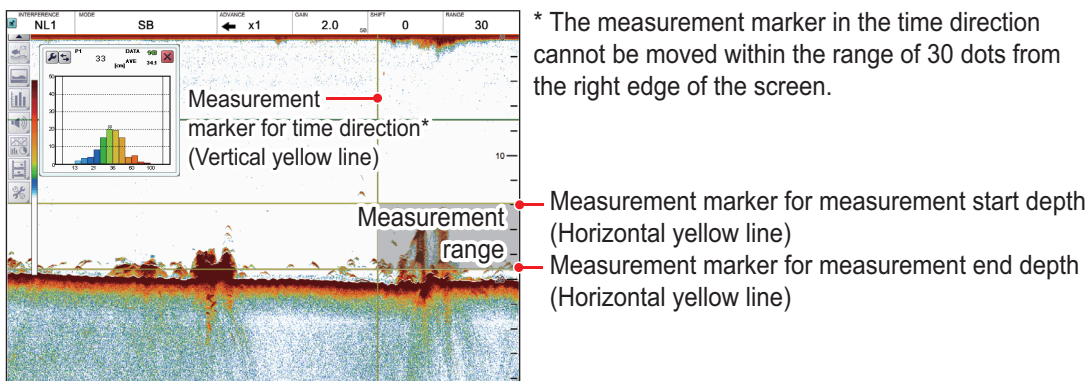

1. Switch to a display that includes the split beam display ([MODE] indication: [SB]).
2. Click the [Sounder] icon () from the InstantAccess bar™ to show the [Sounder] menu bar, then click the [Fish Size Measurement] icon () to show menu options.
3. Click the [Specific Range] icon ().
The measurement markers for the start and end depths (horizontal yellow solid lines) and the measurement marker for time direction (vertical yellow dashed line) appear.



4. Adjust the area to suit your requirements.
(1) Drag and drop the upper limit bar to move the upper and lower range limit bars together, (2) drag and drop the lower limit bar to adjust the width of the range, (3) drag and drop the measurement location to set where the fish measurements are made, and (4) drag and drop the measurement marker for time direction (vertical yellow dashed line) left or right to change to change the horizontal measurement range.

2.2.5 Bottom trace

This method produces two marker lines. The horizontal, small line at the right-hand edge of the screen is the measurement range marker. The vertical line is the measurement location.

1. Switch to a display that includes the split beam display ([MODE] indication: [SB]).
2. Click the [Sounder] icon () from the InstantAccess bar™ to show the [Sounder] menu bar, then click the [Fish Size Measurement] icon () to show menu options.
3. Click the [Bottom Trace] icon (). [FISH TRACK] appears in the Miscellaneous section of the header. The start depth measurement marker (horizontal yellow solid line) and the time direction measurement marker (vertical yellow dashed line) appear.

Note: If "----" appears in the depth indication box at the bottom of the screen, the measurement marker is not shown. Measurement is not possible.

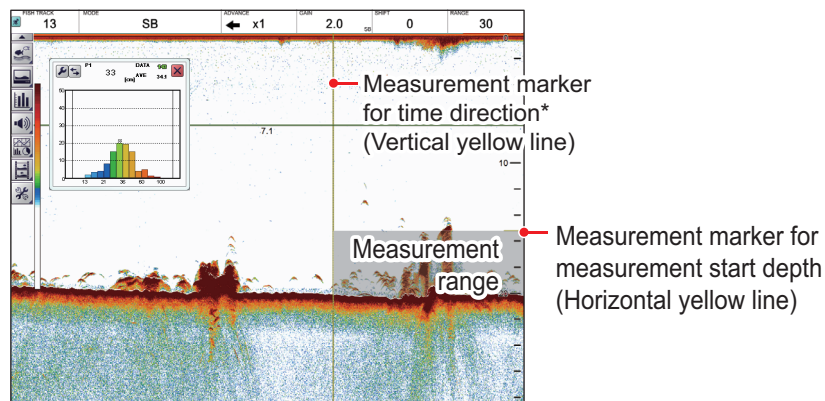

* The measurement marker in the time direction cannot be moved within the range of 30 dots from the right edge of the screen.

4. Put the cursor in the far left-hand window in the header.
5. Click the [FISH TRACK] window, then scroll to change the setting. The [FISH TRACK] window is highlighted in green when its contents can be changed. The larger the value, the wider the measurement range based on the seabed position, and the smaller the value, the narrower. The measurement marker for measurement start depth (horizontal yellow solid line) moves according to the set value.

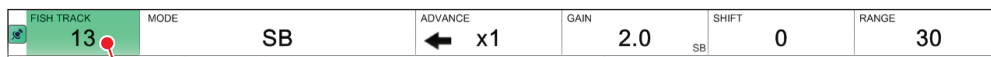



[FISH TRACK] window

6. Drag and drop the measurement marker for time direction (vertical yellow dashed line) to adjust the measuring range.

2.2.6 Specific area

This method allows you to specify up to three square-shaped areas. To set up one or more detection areas, do the following:

1. Switch to a display that includes the split beam display ([MODE] indication: [SB]).
2. Click the [Sounder] icon () from the InstantAccess bar™ to show the [Sounder] menu bar, then click the [Fish Size Measurement] icon () to show menu options.
3. Click the [Specific Area] icon (). [FISH AREA] appears in the Miscellaneous section of the header.
4. If the header is not shown, move the cursor to the top edge of the display.
5. Click the [FISH AREA] indication on the header. Scroll to change the area you want to set, [SIZE1], [SIZE2] or [SIZE3]. The indication is highlighted in green color.

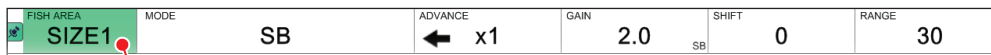

[FISH AREA] window

6. To set the measuring area, place the cursor at one corner of the area, then press and hold the **left button**. Drag the cursor to desired position then release the button.

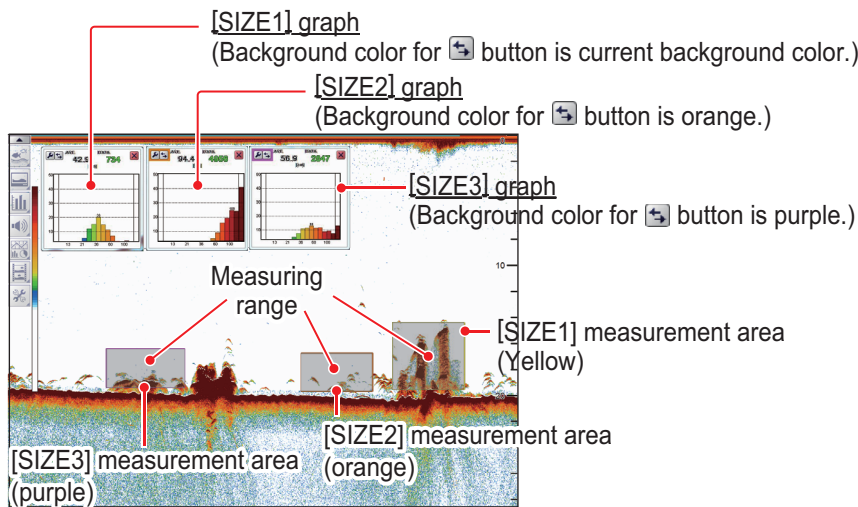



7. If necessary, adjust the measuring area by changing the position and size of the measuring marker.
8. Repeat steps 5 - 7 to set other measuring ranges.

Note: To get automatic operation, set [Auto Specific Area] in the [Fish Size] menu to Off.

2.2.7 How to change fish size graph settings

Several aspects of the graphs can be changed from the [Fish Size] menu.

Fish Size menu

1. Click the [Advanced Settings] icon () from the InstantAccess bar™, then click the [Advanced Settings] icon () to show the [Advanced Settings] window.
2. Click [Fish Size] to show the [Fish Size] settings on the right-side of the window.

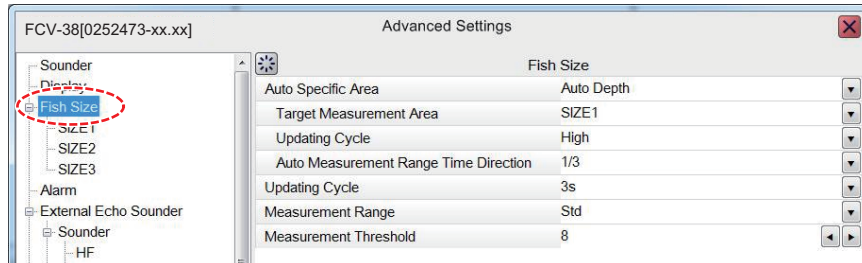

3. Referring to the table below, select the measurement option to change, then change the settings as required.

Item	Description
[Auto Specific Area]	<p>This menu item is valid when the measuring mode is [Specific Area].</p> <ul style="list-style-type: none"> ● [Auto Specific Area]: Sets whether to use the automatic adjustment function of the measuring range during the specific area measuring mode. Up to three measurement ranges can be set, but automatic adjustment is performed only for the measuring range selected with [Target Measurement Area] below. <ul style="list-style-type: none"> • [Auto Depth]: Even if the depth at which a single fish is present changes after setting the measurement range, the measurement range is automatically shifted to a position with a large number of single fish. During automatic adjustment function, the position and size of the measurement marker can be changed. • [Auto Area]: The measurement range that was set is deleted once and the measurement range is automatically set to the place where the number of single fish is large. During automatic adjustment function, the position and size of the measurement marker can not be changed. • [Off]: Disable automatic adjustment ● [Target Measurement Area]: Available when [Auto Specific Area] is set to other than [Off]. Select the measurement area to use with the automatic area adjustment feature. ● [Updating Cycle]: Available when [Auto Specific Area] is set to other than [Off]. Set the updating interval for automatic area adjustment, from among, High (5 s), Medium (15 s), and Low (30 s).

2. GRAPH FUNCTIONS



Item	Description
[Auto Specific Area]	<ul style="list-style-type: none"> • [Auto Measurement Range Time Direction]: Available when [Auto Specific Area] is set to other than [Off]. Set the area to use in automatic area adjustment. <ul style="list-style-type: none"> • [Entire Area]: Automatic adjustment on all areas. • [1/2]: Automatic adjustment is done from the right edge of the screen to 1/2 the screen width. • [1/3]: Automatic adjustment is done from the right edge of the screen to 1/3 the screen width.
[Updating Cycle]	Sets the updating interval for the fish graph.
[Measurement Range]	Sets the depth range for fish size measurement for all modes except bottom trace. [Std]: Measurement from the transducer to the seabed. [Entire Range]: Include fish echoes beyond the seabed. This option is useful in situations where the seabed is not detected correctly, as it can detect fish which are below the incorrectly detected seabed.
[Measurement Threshold]	Sets the minimum fish size (setting range: 5 - 20 cm) at which to begin fish size detection.

4. Click the [OK] button to finish, or click the [Cancel] button to quit and restore previous setting(s).

SIZE1 - SIZE3 menus

The following menu items change according the measurement mode.

- [Specific Area] measurement mode: Since the [SIZE2] and [SIZE3] menus are enabled, the fish length graph can be set individually. For example, the [SIZE2] fish length graph is set in the [SIZE2] menu.
- Measurement mode other than [Specific Area]: The menu settings for the [SIZE1] menu are reflected to the fish graph.

1. Click the [Advanced Settings] icon () from the InstantAccess bar™, then click the [Advanced Settings] icon () to show the [Advanced Settings] window.
2. Click [SIZE1], [SIZE2] or [SIZE3].

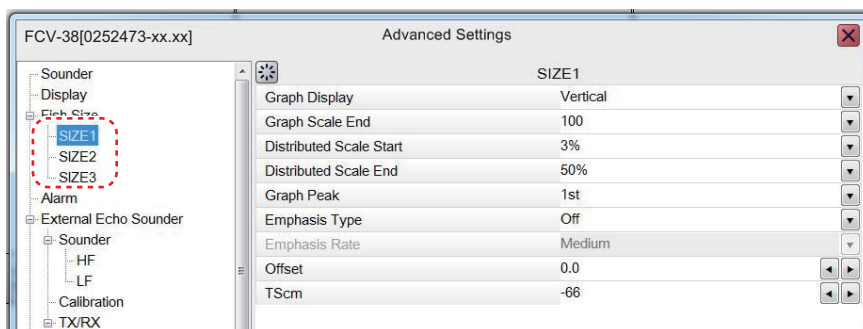

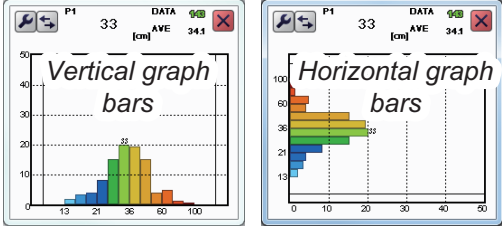
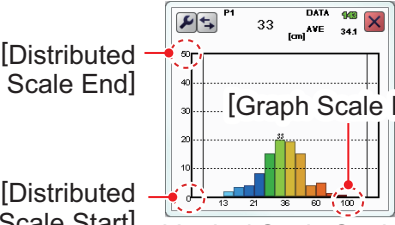
Item	Description								
[Graph Display]	<p>Set the orientation of the graph. Select [Horizontal] or [Vertical] as required.</p> 								
[Graph Scale End]	<p>Sets the maximum fish size to be displayed on the graph. (Setting range: 40 - 200 cm)</p> 								
[Distributed Scale Start]	<p>Sets the percentage of distribution at which data starts appearing on the graph. (See the above figure.)</p>								
[Distributed Scale End]:	<p>Sets the percentage of distribution at which data stops appearing on the graph. (See the above figure.)</p>								
[Graph Peak]	<p>Sets the number of peak measurement to display on the graph.</p> <p>[1st]: Show only the highest peak measurement. [1st + 2nd]: Show the two highest peak measurements. [1st + 2nd + 3rd]: Show the three highest peak measurements.</p>								
[Emphasis Type]	<p>Sets the degree of peak emphasis, among the following options. The larger the number, the longer the bar that shows peak</p> <ul style="list-style-type: none"> • [Off]: Disable peak emphasis processing. • [Type 1]: Emphasize small peaks centering on 1st peak. • [Type 2]: Each peak is emphasized, multiple peaks are separated and emphasized. • [Type 3]: Emphasize large peaks centering on 1st peak. 								
[Emphasis Rate]	<p>This item is adjustable when [Emphasis Type] is set to other than [Off]. Emphasizes the peak of the fish length graph. For the "Strong" setting, the peak bar is displayed longer.</p>								
[Offset]	<p>Compensates for error in displayed fish size. For example, if the displayed value is smaller than the actual value, enter a positive value.</p> <table border="1" data-bbox="871 1765 1278 1928"> <thead> <tr> <th>Value set (dB)</th> <th>Size to correct</th> </tr> </thead> <tbody> <tr> <td>+6.0</td> <td>Approx. x2</td> </tr> <tr> <td>+1.0</td> <td>Approx. x1.12</td> </tr> <tr> <td>-6.0</td> <td>Approx. x1/2</td> </tr> </tbody> </table>	Value set (dB)	Size to correct	+6.0	Approx. x2	+1.0	Approx. x1.12	-6.0	Approx. x1/2
Value set (dB)	Size to correct								
+6.0	Approx. x2								
+1.0	Approx. x1.12								
-6.0	Approx. x1/2								
[Tscm]	<p>Available when [cm] or [inch] is selected for [Fish Size] in the [User Interface Settings] menu. Set [TScm] according to targeted fish specie to get more accurate measurement of fish length.</p>								

2. GRAPH FUNCTIONS

- Click the [OK] button to finish, or click the [Cancel] button to quit and restore previous setting(s).

2.3 Target Graphs

The target graphs plot, within a circle representing the target measurement range, the locations of individual fish in relation to your vessel. Two types of graphs are available, vertical and horizontal. The target position graph can only be displayed on the split beam screen.

The target graphs can be resized and moved as necessary. Drag an edge of the window to resize the graph. Drag and drop the window to change location.

Note 1: The measurement area for the target graphs is shared with the [Fish Size Graph].



Note 2: When the measurement mode is set to [Specific Area], the measurement range of SIZE1 is applied to the target position graph.

2.3.1 Vertical target graph

With a "bird's-eye-view" of fish below your vessel and your vessel at the center of the graph display, this graph mode is ideal for keeping track of your heading in relation to schools of fish and also determining fish distribution surrounding your vessel.

Fish echoes from the last three scans are displayed, which helps to track schools.

To show the [Vertical Target Graph], do the following:

- Click the [Graph] icon () from the InstantAccess bar™ to show the [Graph] menu.
- Click the [Target Graph] icon () followed by the [Vertical Target Graph] icon (). The icon changes to a green color and the [Vertical Target Graph] appears.

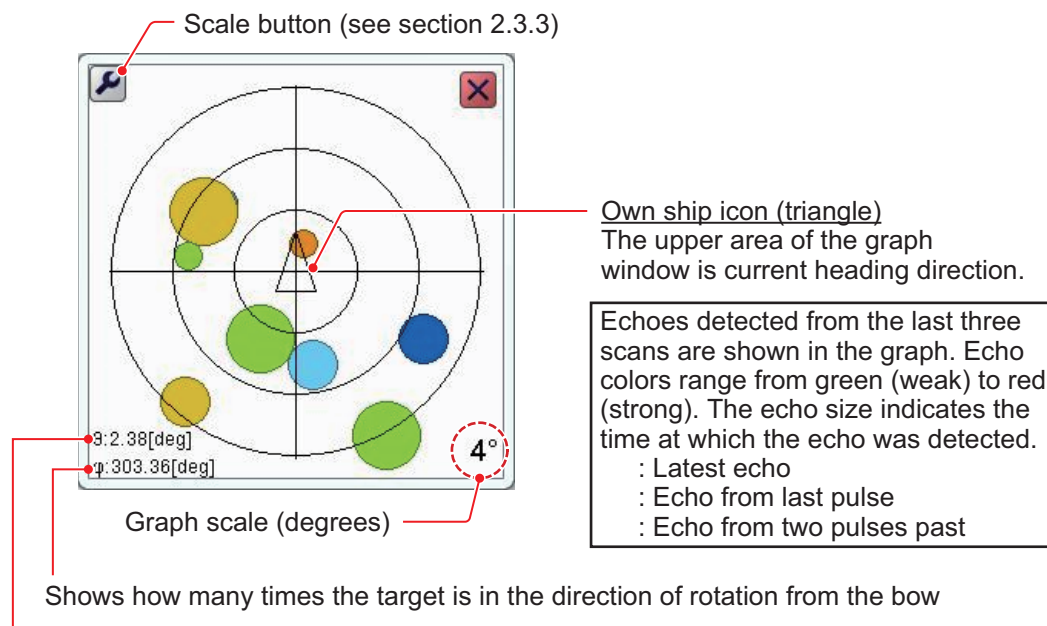



Shows how many times the target is outside the center

To close the graph, click the [Close Window] icon (), or click the graph icon.

2.3.2 Horizontal target graph

The [Horizontal Target Graph] mode gives a view of fish echoes in the stern direction. The depth at which the echoes were detected and the distribution is displayed, making this mode ideal for estimating the type of fish.

To show the [Horizontal Target Graph], do the following:

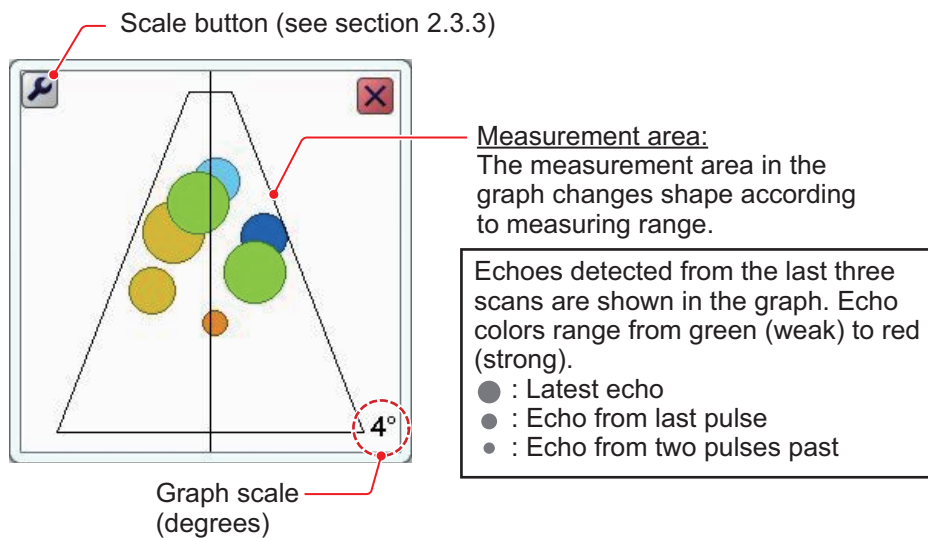

1. Click the [Graph] icon () from the InstantAccess bar™ to show the [Graph] menu.
2. Click the [Target Graph] icon () followed by the [Horizontal Target Graph] icon (). The icon changes to a green color and the [Horizontal Target Graph] appears.



To close the graph, click the [Close Window] icon (), or click the graph icon.

2.3.3 How to change the graph scale (target graphs only)

To change the target graph scale, do the following:

1. With either the vertical or horizontal target graph displayed, click the scale button () at the top-left corner of the graph to show the [Target Graph] window.
2. Click the [Scale] value to show the setting adjustment buttons (). Decrease or increase the scale as required. The available range is 2° to 8° from directly below own ship. A larger setting gives a wider detection area.
3. Click [OK].

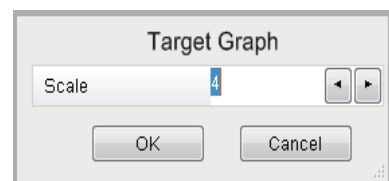



2.4 Sonde Graph

The [Sonde Graph] plots depth and water temperature data, input from a net sonde, in the specified line color.

The data displayed is input from the net sonde with the lowest number in the list of sondes selected at [Sonde Mark] from the [Display] section of the [Advanced Settings] menu. See section 4.3.

To show the [Sonde Graph], do the following:

1. Click the [Graph] icon () from the InstantAccess bar™ to show the [Graph] menu.
2. Click the [Sonde Graph] icon (). The icon changes to a green color and the [Sonde Graph] appears.

The depth and temperature at the sonde location appears on the graph. The depth scale reflects any changes to the fish finder depth scale.

The sonde graph window can be resized and moved as necessary. Drag an edge of the window to resize the graph. Drag and drop the window to change location.

To close the graph, click the [Close Window] icon (), or click the graph icon.

Note: You can clear the [Sonde Graph] and start a new graph at any time. Click the [Refresh] button on the sonde graph to clear the graph and start a new graph.

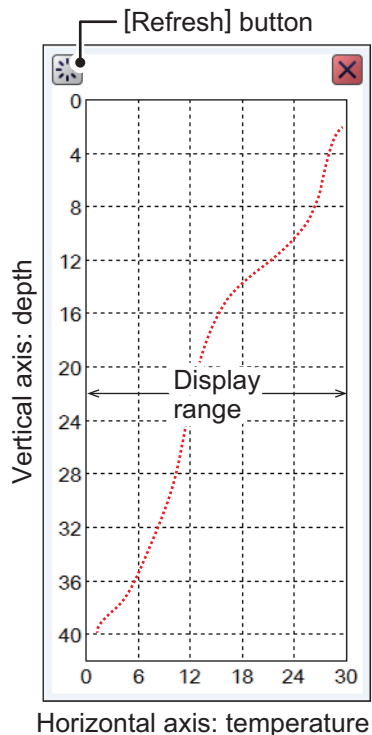



2.5 Temp Graph

The [Temp Graph] plots water temperature using water temperature data, in a blue dotted line across the screen.

Note 1: Water temperature data is required to use this feature.

Note 2: The data source for water temperature input is set at installation. For details, consult your local dealer.

To show the [Temp Graph], do the following:

1. Click the [Graph] icon () from the InstantAccess bar™ to show the [Graph] menu.
2. Click the [Temp Graph] icon (). The icon changes to a green color and the [Temp Graph] appears.

To close the graph, click the [Close Window] icon (), or click the graph icon.

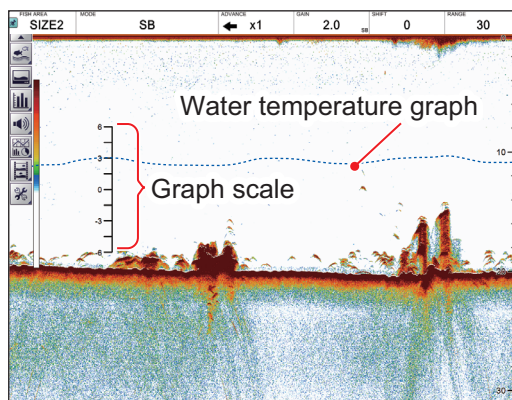

2.6 Bottom Information Graphs

There are two bottom information graphs, the hardness graph and the roughness graph. The graphs can be displayed together or alone. The graphs can only be shown on the split beam display.

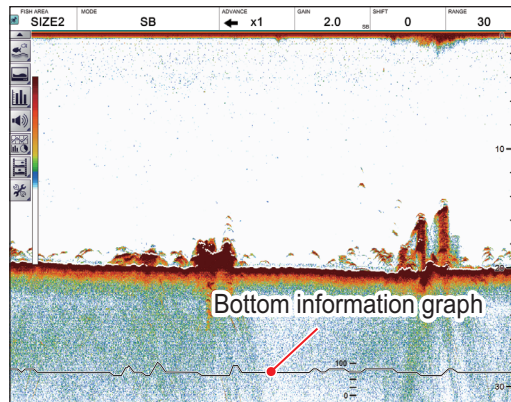



2

2.6.1 Hardness graph

The [Hardness Graph] plots the estimated seabed hardness as a solid line graph (line color: white) along the bottom of the screen. The graph indicates estimated composition, such as rocks or gravel, which can be useful for finding a seabed type preferred by targeted fish.

To show the [Hardness Graph], do the following:



1. Click the [Graph] icon () from the InstantAccess bar™ to show the [Graph] menu.
2. Click the [Bottom Information] icon () followed by the [Hardness Graph] icon (). The icon changes to a green color and the [Hardness Graph] appears.

To hide the hardness graph, click the "Graph" icon on the Instant Access Bar™, then click the "Bottom Information Graph" and "Hardness Graph" icons.

2.6.2 Roughness graph

The [Roughness Graph] plots the estimated seabed roughness as a solid line graph (line color: pink) along the bottom of the screen. The graph indicates estimated bottom contour, to alert you to seafloor roughness before you drop your fishing gear.

to show the [Hardness Graph], do the following:

1. Click the [Graph] icon () from the InstantAccess bar™ to show the [Graph] menu.
2. Click the [Bottom Information] icon () by the [Roughness Graph] icon (). The icon changes to a green color and the [Roughness Graph] appears.

To hide the roughness graph, click the "Graph" icon on the Instant Access Bar™, then click the "Bottom Information Graph" and "Roughness Graph" icons.

3. SCREENSHOTS & DATA RECORDING



3.1 Screenshots (still images)

You can save a screenshot of the on-screen display and play it back at any time. This is helpful in comparing the sizes of schools of fish.

3.1.1 How to set the save destination for screenshots

Screenshots can be saved to the Processor Unit's internal memory, or to an external memory device. The Processor Unit can hold up to 99 screenshot files. For external memory devices, the number of files that can be saved depends on the capacity of the external memory device.

To set the save destination for screenshots, do the following:

1. Click the [Advanced Settings] icon () from the InstantAccess bar™, then click the [Advanced Settings] icon () to show the [Advanced Settings] window.
2. Double-click [System], then click [User Interface Settings] to show the [User Interface Settings] menu.

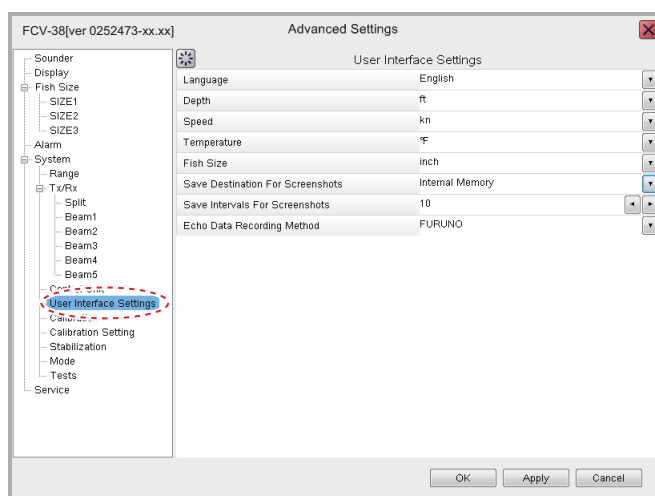

3. Click [Save Destination for Screenshots] and appropriate option, referring to the descriptions below.
[Internal Memory]: Saves the screenshots to the Processor Unit.
[External Memory]: Saves the screenshots to the connected external memory device.
4. Click [OK] to finish.

3.1.2 How to take a screenshot

To take a screenshot, press the scrollwheel on the Trackball Control Unit.

Where the save destination is set to [Internal Memory], the footer shows the total number of screenshots saved to the Processor Unit.

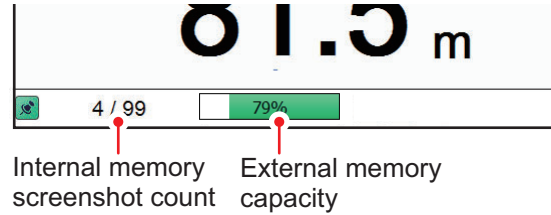

Where the save destination is set to [External Memory], the footer shows the percentage of space available on the external memory device.

The file format for saved screenshots is JPEG (Joint Photographic Experts Group).

Note 1: Where the internal or external memory has insufficient space to save a new screenshot, the error message "Not enough memory to save screenshot. Delete unnecessary files." appears.

To rectify the problem, do one of the following:

- Delete unnecessary files (see section 3.1.6).
- Moved saved files to an external memory device (see section 3.1.5).

Note 2: If a screenshot is taken when [External Memory] is selected and no external memory device is connected, the error message "External memory is not connected." appears.

Check that the external memory is connected correctly.

3.1.3 How to take screenshots at a set interval



Several screenshots can be taken at set intervals. To use this function, do the following:

Note 1: The interval (in seconds) at which screenshots are recorded is set at [Save Intervals for Screenshots] in the [System] section of the [Advanced Settings] menu. The available interval is 10 - 600 (seconds).

Note 2: Connect the external memory device to the USB port on the Processor Unit. Do not connect the external memory device to the USB port on the Trackball Control Unit.

Note 3: [Static Display Recording: Start/Stop] is not selectable from the menu if the external memory device is not correctly connected.

Note 4: For use of the Multi-Screenshot function, use of an external HDD is recommended.

1. Click the [Echo Recording] icon () from the InstantAccess bar™, then click the [Multi-Screenshot Start/Stop] icon (). Screenshots are now saved at regular intervals and the [Static Display Recording: Start/Stop] icon is displayed in green color.
2. Click the [Multi-Screenshot Start/Stop] icon () to stop recording.

3.1.4 How to replay a screenshot

To replay a saved screenshot, press and hold the scrollwheel on the Trackball Control Unit. The replay screen is displayed and the oldest screenshot is shown. A total of 1000 screenshots can be load to replay.

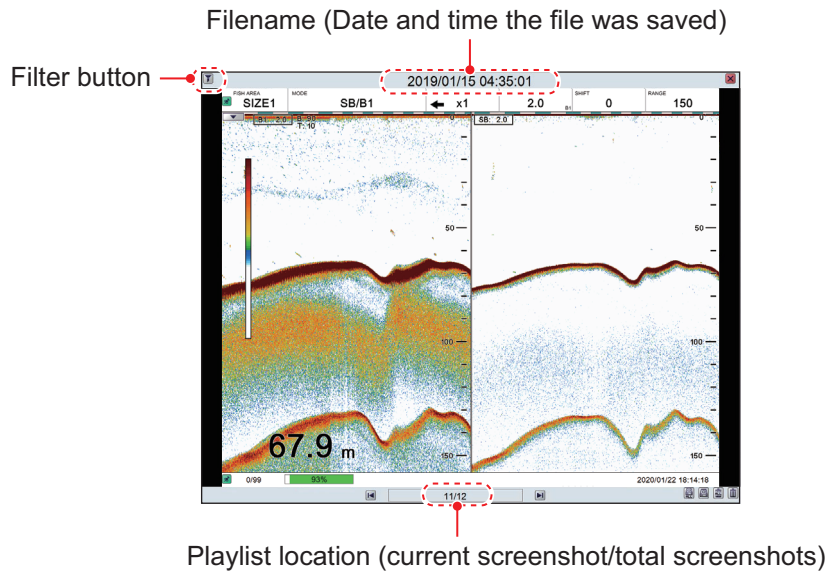

To change the displayed file, press the arrow buttons (⏪) or (⏩).

To close the replay screen, press the ✖ icon a the top-right of the screen.

Note 1: Where there are no screenshots to play back and the scrollwheel on the trackball is pressed and held, a blank screen (black color) appears.

Note 2: The indication for the number of current screenshots and total screenshots is located at the bottom of the screen (see figure above). This indication shows the number of screenshots at the time of opening the replay screen and does not reflect any new screenshots taken while the replay screen is open. To refresh the count, close, then re-open the replay screen.

How to filter the screenshots that are displayed

Click the filter icon (⏸) at the top-left of the screen to show the filtering options pop-up window. Select the appropriate check box to show the filtering options. You can select either of, or both of the filters.

- [Date Time]: Apply a filter based on date. You can select a single filter (for example, filter by month only) or a mixed filter (for example, filter by year, month and date).
- [Position]: Apply a filter based on a specific location and/or a nautical mile radius from the specified point.

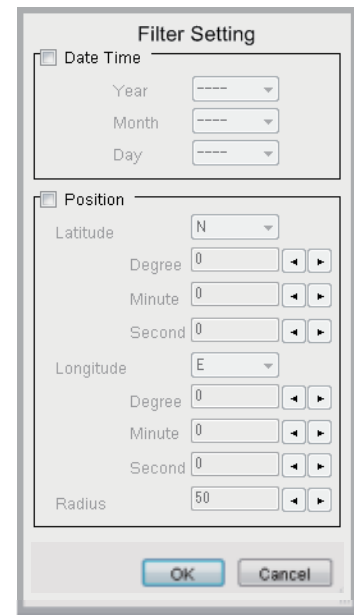



3.1.5 How to copy screenshots from internal to external memory



You can copy screenshot files from the internal memory of the Processor Unit to an external memory device (for example a USB flash drive).

Note 1: If the external memory device does not have the capacity to store the screenshot files, the error message "Not enough memory to copy screenshot. Delete unnecessary files." appears.

To rectify this problem, delete unnecessary files from the device to create room for the screenshot files, then repeat the above procedure.

Note 2: If no external memory device is connected, the [Copy] () and [Copy All] () icons are greyed out. You cannot move files.

How to copy a single screenshot file

1. Long-push the scrollwheel on the Trackball Control Unit to show the screenshot replay screen.
2. Click the arrow buttons ( or ) to select the file to copy.
3. Click the [Copy] () icon at the bottom-right corner to copy the screenshot.



How to copy all screenshot files

1. Long-push the scrollwheel on the Trackball Control Unit to show the screenshot replay screen.
2. Click the [Copy All] () icon at the bottom-right corner to copy all screenshot files.

3.1.6 How to delete screenshot files

You can delete screenshot files in two manners: individually, or all at once.

How to delete a single screenshot file

1. Long-push the scrollwheel on the Trackball Control Unit to show the screenshot replay screen.
2. Click the arrow buttons ( or ) to select the file to delete.
3. Click the [Delete] () icon at the bottom-right corner to delete the screenshot file.

How to delete all screenshot files (files stored in internal memory)

1. Long-push the scrollwheel on the Trackball Control Unit to show the screenshot replay screen.
2. Click the [Delete All] () icon at the bottom-right corner. You are asked if you are sure to delete all screenshot files.
3. Click [Yes] to proceed with the file deletion. Click [Cancel] to abort the file deletion.



3.2 Echo Data Recording and Playback

The echo data recording and playback function requires connection to an external memory device. Echo data is recorded as a "movie", allowing you to playback previously recorded echo data, such as schools of fish, at your convenience.

3.2.1 How to set the echo data recording format

Select the echo data recording method as shown in the procedure below.

Note: Settings cannot be changed while echo data is being recorded.

1. Click the [Advanced Settings] icon () from the InstantAccess bar™, then click the [Advanced Settings] icon () to show the [Advanced Settings] menu.
2. Double-click [System], then click [User Interface Settings] to show the [User Interface Settings] menu.
3. Click [Echo Data Recording Method] and appropriate option, referring to the descriptions below.

[FURUNO]: Images are saved in FURUNO format. These images can be played back on the FCV-38.

[NetCDF4]: Images are saved in NetCDF4 (Network Common Data Form) format, a fish finder format primarily used by scientists. These images cannot be played back on the FCV-38. Specialized software is necessary.

Note: The split beam display mode must be active to record echo data in NetCDF4 format.

4. Click [OK] to finish.

3.2.2 How to record echo data

To start data recording, click the [Echo Recording] menu icon from the InstantAccess bar™, then click the [Record] icon. To stop the recording at any time, click the [Stop] icon.

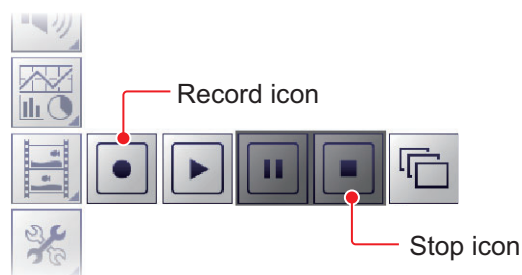

The amount of memory used for recording echo data varies, depending on configuration and settings. For example, with no external fish finder connected, no display division and the range set to 150 m, the estimated memory usage is 4.7 GB per hour.

Note 1: An external memory device with 500 GB capacity, or higher, is recommended for this function.

Note 2: The external memory device should be formatted as NTFS. Other formats may not be compatible with recording.

Note 3: When there is no external memory device connected, the [Echo Recording] icon is not selectable.

3. SCREENSHOTS & DATA RECORDING

Note 4: Connect the external memory device to the USB port on the Processor Unit. Do not connect the external memory device to the USB port on the Trackball Control Unit.

Note 5: When an external memory device is connected and the capacity for the device reaches its limit, recording is stopped and the message "Recording stopped because memory capacity is full. Check capacity." appears.

Delete unnecessary files from the external memory device, or take other appropriate measures to allow sufficient capacity to save the echo data.

Note 6: When the external memory device does not have sufficient memory to begin data recording, and you attempt to record data, the message "Not enough memory to start recording. Delete unnecessary files." appears.

Delete unnecessary files from the external memory device, or take other appropriate measures to allow sufficient capacity to save the echo data.



Note 7: If the display mode does not include split beam when you attempt to record in NetCDF4 format, you are informed that NetCDF4 recording cannot be started because the display mode is not SB (Split Beam). Change the display mode to SB then click the [Record] button again.

3.2.3 How to play back recorded echo data

The playback function lets you view echo data you previously recorded. The display mode used for playback should match the settings used when the echo data was recorded, or the echoes may not be displayed correctly.

Adjustments made to gain and other echo settings are not reflected to the echo data being played back.

To play back recorded echo data, do the following:

1. Click the [Echo Recording] icon () from the InstantAccess bar™, then click the Play icon (). The file selection dialog shown below appears.

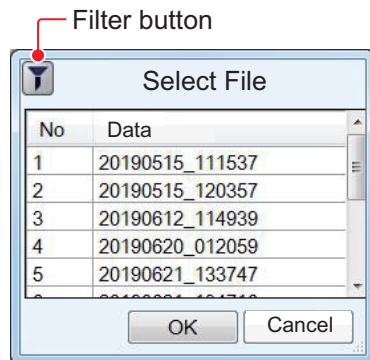

2. If you need to filter the files, select the filter button, indicated in the figure on the previous page. The filter options window, shown below, appears. If you have no need to filter the files, go to step 4.

The screenshot shows a dialog box with three main sections:

- Specify Date:** Includes dropdown menus for Year, Month, and Day.
- Specify Position:** Includes dropdown menus for Latitude (N) and Longitude (E), and input fields for Degree, Minute, and Second for both. A Radius [nm] field is set to 50.
- Sort Recordings:** Includes checkboxes and input fields for Minimum Time (1), Maximum Time (2), Minimum Depth (40), and Maximum Depth (80).

Red arrows on the right side of the dialog point to each section with the following labels:

- Date filter options
- Position filter options
- Sort filter options

At the bottom of the dialog are 'OK' and 'Cancel' buttons.

3. Referring to the table below, set the appropriate file filters, then click [OK].

Filter type	Description
[Specify Date]	Applies a filter based on date. You can select a single filter (for example, filter by month only) or a mixed filter (for example, filter by year, month and date).
[Specify Position]	Applies a filter based on a specific location and/or a nautical mile radius from the specified point.
[Sort Recordings]	Applies a filter based on the playback time of the record, the depth recorded, or a mix of time and depth. <ul style="list-style-type: none"> [Minimum Time]/[Minimum Depth]: Records with a time/depth below this setting are not displayed. [Maximum Time]/[Maximum Depth]: Records with a time/depth above this setting are not displayed.

3. SCREENSHOTS & DATA RECORDING

- Select the file to play back, then click [OK]. The selected file is played back. Some settings, such as gain and fish size measurements, can be adjusted during playback.

Note 1: To replay echo data from an external fish finder, set the mode to the one used to record the data, to ensure proper replay of data.

Note 2: Setting changes such as gain adjustment are not reflected in the echo data from an external fish finder.

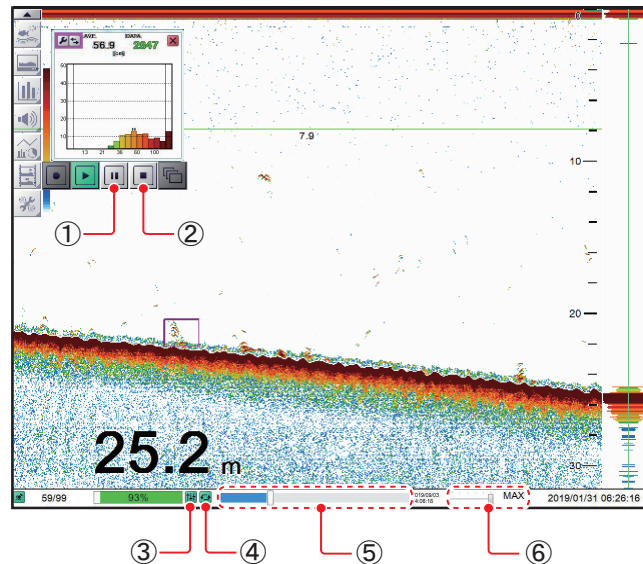



No.	Name	Description
1	[Pause] icon	Pauses the playback. Click the [Play] icon to continue playback.
2	[Stop] icon	Stops the playback.
3	[Settings] icon	Applies your current settings to the playback file. This icon is shown in green color when in use.
4	[Loop] icon	Loops the playback.
5	[Playback Location] indicator	Indicates your current location in the overall playback. Select the slide bar, then drag the locator to change the playback location.
6	[Playback Speed]	Selects the speed to playback the record. The available options are: <ul style="list-style-type: none"> [2000]/[1500]/[1000]/[500] ms: Play the record at the set millisecond speed. [RT]: Play the record at real time speed (the speed at which it was recorded). [MAX]: Play the record at maximum playback speed.

- Click the Stop icon () to stop the playback.

3.3 How to Select an External Memory Device

Where more than one external memory device is connected to the FCV-38, you can select the device which will be used for data recording and saving screenshots*.

*: [Screenshot Recording Destination] must be set to [External Memory] to save screenshots to an external memory device.

1. Click the [Advanced Settings] icon () from the InstantAccess bar™.
2. Click the [Select External Memory Device] icon ().
Note: The [Select External Memory Device] icon is only displayed when there is an external memory device connected to the FCV-38.
3. Select the appropriate external memory device to use.
 When the cursor is placed on the icon for an external memory device, the highlighted device's capacity (available space/maximum space) is displayed.

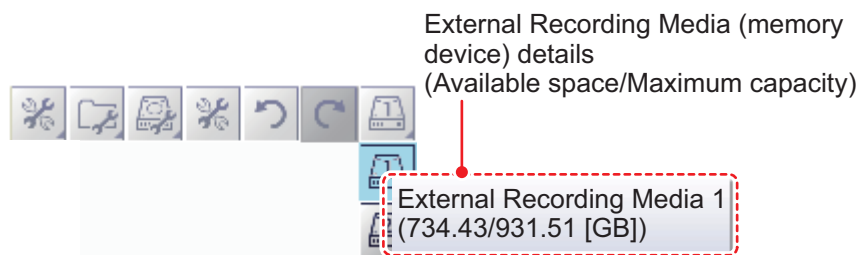



3. SCREENSHOTS & DATA RECORDING

This page is intentionally left blank.

4. ADVANCED SETTINGS

4.1 How to Access the Advanced Settings Menu

To show the [Advanced Settings] menu, click the [Advanced Settings] icon () from the InstantAccess bar™, then click the [Advanced Settings] icon () to show the [Advanced Settings] window.

Where [External Fish Finder Window] is set to [On] at installation, you can access external fish finder settings from a sub monitor by right-clicking a non-interactive section of the screen. The external fish finder settings are not available from the [Advanced Settings] menu. See section 4.8.

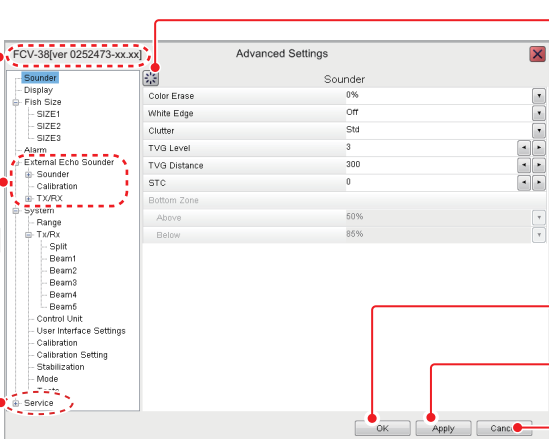

The screenshot shows the 'Advanced Settings' window with a tree view on the left and a settings table on the right. Callouts provide the following information:

- Software version (program number) "xx.xx" denotes minor changes.** Points to the top of the tree view showing 'FCV-38[ver 0252473-xx.xx]'. A red dashed box highlights the version string.
- Shown when external echo sounder is connected and [External Fish Finder Window] is set to [Off] (at installation).** Points to the 'External Echo Sounder' section in the tree view. A red dashed box highlights this section.
- Accessible only by service personnel.** Points to the 'Service' option at the bottom of the tree view. A red dashed box highlights this option.
- Select this icon to reset the current menu settings to factory default.** Points to the 'Factory Default' icon (a gear with a reset symbol) in the top right of the settings table.
- Confirm changes and close the menu.** Points to the 'OK' button at the bottom right.
- Apply changes. (Menu remains open).** Points to the 'Apply' button at the bottom right.
- Cancel changes and close the menu.** Points to the 'Cancel' button at the bottom right.

Section	Setting	Value
Sounder	Color Erase	0%
	White Edge	Off
	Clutter	Std
	TVG Level	3
	TVG Distance	300
STC	STC	0
	Bottom Zone	
Bottom Zone	Above	50%
	Below	85%

4.2 Sounder Menu

The [Sounder] section of the [Advanced Settings] menu contains the settings for sounders connected to the FCV-38. For external sounders, see section 4.6, section 4.8.

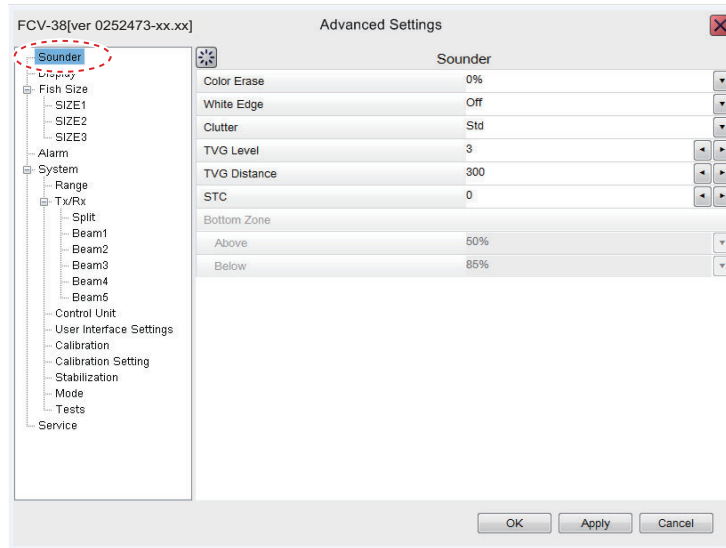

Menu item	Description
[Color Erase]	Erases unwanted noise. See section 1.26.
[White Edge]	Gives the seabed echo a white edge. Useful when trying to separate bottom-feeding fish from the seabed. Set a high value for a thick white line or a low value for a thin white line. Set to [Off] to disable this function.
[Clutter]	Removes unwanted echoes (sediment, etc.). See section 1.12.
[TVG Level]	Time Varied Gain. Adjusts the TVG level. See section 1.27.
[TVG Distance]	Adjusts the maximum distance at which TVG is applied. See section 1.27.
[STC]	Sensitivity Time Control. Removes unwanted echoes near the surface. Use this function when you want to see fish near the surface clearly. Set the STC value according to your requirement. A setting of [0] disables the STC. Note: A high STC setting can erase fish echoes. It is recommended to watch your display when adjusting the STC.
[Bottom Zone] - [Above]& [Bottom Zone] - [Below]	Sets the area in which the seabed is displayed when auto-range mode is active. Note: This menu item is available only if [Auto Range] is not selected from the [Range] → [Auto] menu in the [System] menu.

4.3 Display Menu



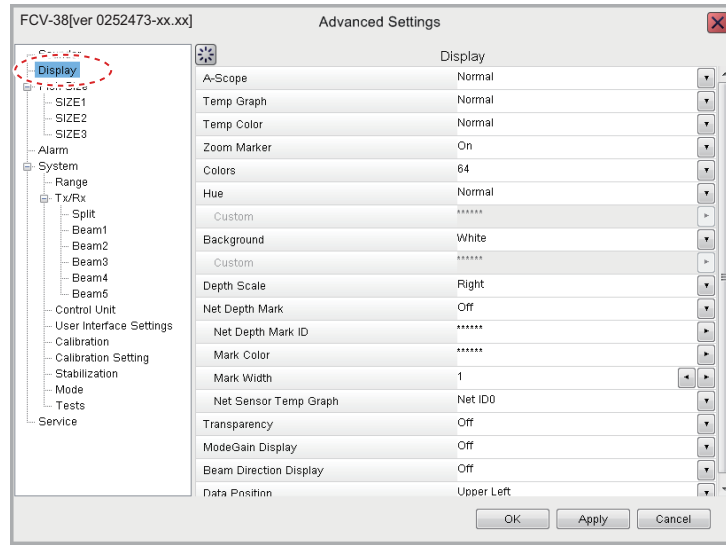

The [Display] section of the [Advanced Settings] menu contains the settings for what data to display and how to display the data on your screen.

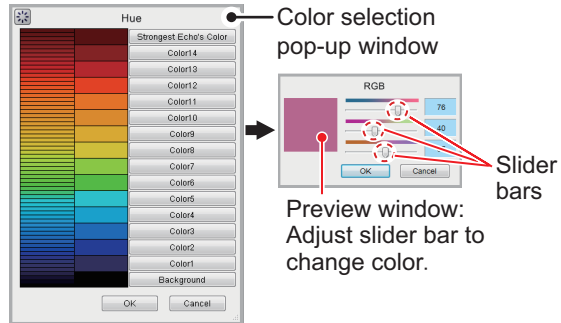



Menu item	Description
[A-Scope]	Shows echoes at each transmission with amplitudes and tone proportional to their intensities. <ul style="list-style-type: none"> [Normal]: The display shows echoes at each transmission with amplitudes and tone proportional to their intensities. [Peak]: "Normal" A-scope display plus peak-hold amplitude picture for last five seconds, shown in dots.
[Temp Graph]	Requires water temperature data. Display a graph showing the water temperature in one of three layouts ([Narrow], [Normal] or [Wide]).
[Temp Color]	Select the color in which the temperature graph displays temperatures. The [Normal] setting displays the graph in light blue.
[Zoom Marker]	Shows/hides the zoom marker (indicates the zoom start and end positions) on the split beam screen when the zoom display (window) is active.
[Colors]	Selects the number of colors available for the color bar and echoes.
[Hue]	Adjusts the color scheme to suit your needs. There are eight options: <ul style="list-style-type: none"> [Normal]: Factory default color scheme. [Hue1] to [Hue6]: Preset color schemes. [Custom]: Creates a custom color scheme. Where [Custom] is selected, the Custom menu item is selectable. Click the (▶) icon to show the color selection pop-up window. Select a color, then adjust the color settings from the color mixing pop-up window. Adjust the slide bars to create a color. Click the [OK] button to finish, or click the [Cancel] button to revert to the previous color setting.

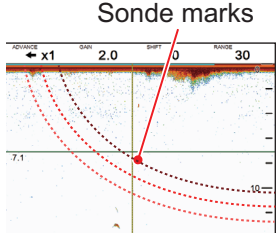
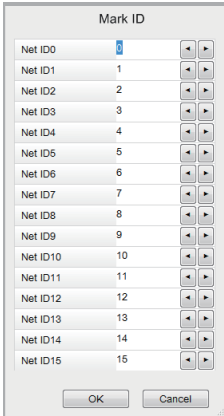
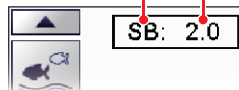

4. ADVANCED SETTINGS

Menu item	Description
[Background]	<ul style="list-style-type: none"> [Background]: Changes the background color. This setting is not selectable when [Hue] is set for [Custom]. In this case the background color is set on the [Hue] window. [Custom]: Sets a custom background color, or select a preset color. The setting is changeable when [Background] is set to [Custom]. Change the background color as follows: <ol style="list-style-type: none"> Click the () icon next to [Custom] to show the color setting window. Adjust the slider bar to select a color. Click the [OK] button to save the color, or click the [Cancel] button to cancel changes.
[Depth Scale]	Select where to display the depth scale, [Right], or [Center].
[Net Depth Mark]	<ul style="list-style-type: none"> [Net Depth Mark]: Shows/hides the net depth mark (depth at the installation position of the net sonde transmitter). [Net Depth Mark ID]: Assigns the net depth mark and net sonde/net sensor ID (ID number of the transmitter you want to display depth information). Set net depth mark ID as follows: <ol style="list-style-type: none"> Click the () icon to show the [Mark ID] window. Set the net sonde/net sensor ID corresponding to the net mark number (0 - 15). For example, to set [Net ID0] as [ID20], click the arrow buttons ( ) for [Net ID0] to set [20]. Click the [OK] button to confirm setting, or click the [Cancel] button to escape and restore previous setting. <p>Note: The same ID number cannot be set for net mark 0 to net mark 15.</p> [Mark Color]: Sets the color for the displayed net depth marks and the temperature graph. <ol style="list-style-type: none"> Click the () icon to show the color selection pop-up window. Select the appropriate sonde number at the right-side of the color selection pop-up window. Adjust the slide bar to change the displayed color of the sonde. Click [OK] to confirm the changes, or click [Cancel] to cancel the changes. [Mark Width]: Sets the thickness at which the sonde line is displayed on-screen. Select a higher setting to increase the thickness. [Net Sensor Temp Graph]: The assigned net mark ID (0 - 15) appears on the net water temperature graph. Only one graph can be displayed, <div data-bbox="1098 600 1374 831" style="float: right;">  <p style="text-align: center;">Sonde marks</p> </div> <div data-bbox="1150 853 1374 1267" style="float: right;">  </div>
[Transparency]	<p>Adjusts the level of transparency for the fish graph, target position graph, and temperature graph. A higher setting increases the transparency, however the graph bars, scale and indications in the graph are not made transparent.</p> <p>Note: This equipment uses AlphaBlend technology for transparency processing.</p>
[Mode Gain Display]	<p>Show/hide the mode/gain display (at the top-left corner of the screen).</p> <div data-bbox="1070 1783 1374 1939" style="text-align: right;"> <p>Mode indication Gain indication</p>  </div>

Menu item	Description
[Beam Direction Display]	<p>Shows/hides the beam direction indication which is shown at the top-left corner on the split beam display. Three types of displays are available.</p> <div style="display: flex; justify-content: space-around; align-items: center;"> <div style="text-align: center;">  <p>Figure</p> </div> <div style="text-align: center;"> <p>B: 270 T: 20</p> <p>Letter</p> </div> <div style="text-align: center;">  <p>Figure+Letter</p> </div> </div> <ul style="list-style-type: none"> • Length of line within [Figure]: Indicates the tilt angle. (10°: radius of inner circle, 20°: radius of outer circle) • Direction of line within [Figure]: Indicates the bearing. <p>Note: The color of the [Figure] depends on the setting of [Simul, TX] in the [TX/RX] menu. See page 4-11. Beams transmitting at the same time have the same color.</p>
[Data Position]	<p>Selects where to display position data on the screen. The choices are [Upper Left], [Lower Left], [Upper Right] and [Lower Right].</p>

4.4 Fish Size Menu

The [Fish Size] menu consists of two menus, [Fish Size] menu and [SIZE1] - [SIZE3] menus, Graph-related measurement can be set from the [SIZE1] - [SIZE3] menus. For details, see section 2.2.7.

Fish Size menu

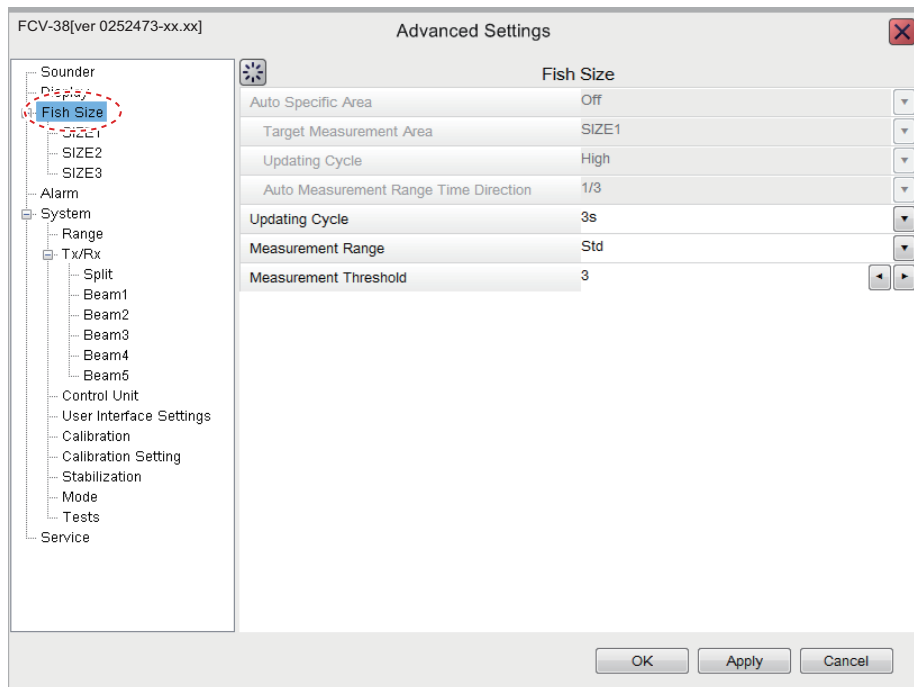

4. ADVANCED SETTINGS

SIZE1 - SIZE3 menu

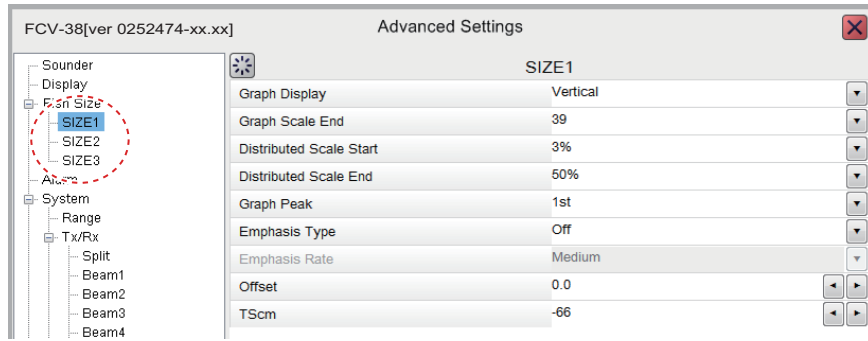

4.5 Alarm Menu

All alarms and their respective conditions can be set from the Alarm section of the [Advanced Settings] menu. For further details on setting alarms and their conditions, see section 1.22.

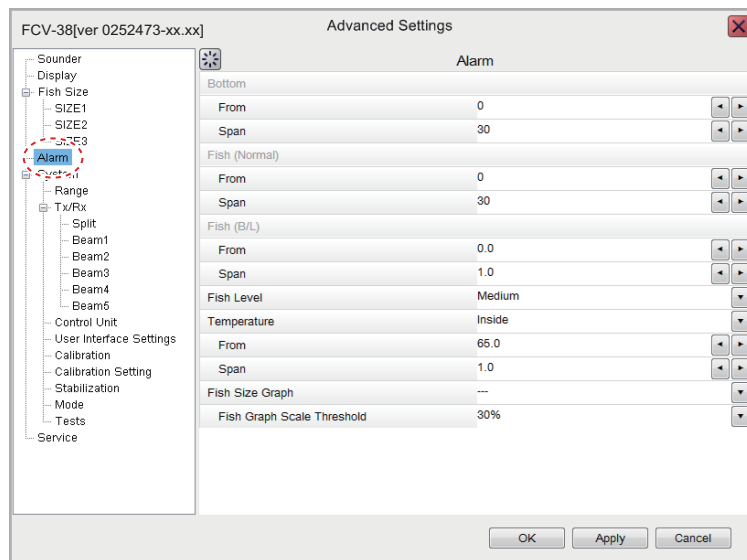

4.6 External Echo Sounder Menu

The external echo sounder can be set from the [External Echo Sounder] section of the [Advanced Settings] menu.

Note 1: The [External Echo Sounder] menu is available only when the DFF3 is connected.

Note 2: Where [External Fish Finder Window] is set to [On] at installation, you can access external fish finder setting from a sub monitor by right-clicking a non-interactive section of the screen. See section 4.8.

4.6.1 Sounder menu

You can adjust several echo display settings for the external sounder from the [Sounder] section of the [External Echo Sounder] menu. To adjust settings for the FCV-38, see section 4.2.

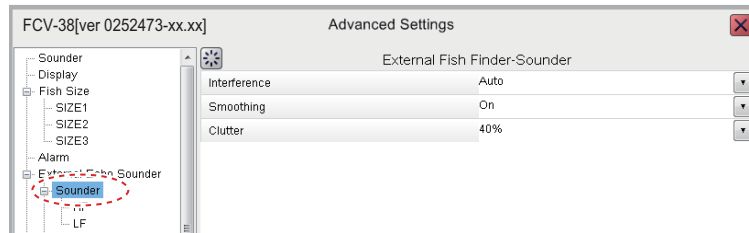

Menu item	Description
[Interference]	Rejects interference from other equipment. See section 1.10.
[Smoothing]	Smooths echo presentation when enabled. Turn smoothing on when echoes appear "spotty" or "jagged". See section 1.11.
[Clutter]	Low intensity "speckles" caused by sediments in the water or noise, may appear over most of screen. These speckles can be suppressed by adjusting the [Clutter]. See section 1.12.

HF and LF menus



HF menu



LF menu

Menu item	Description
[TVG Level]	Adjusts the TVG (Time Varied Gain) level. See section 1.27.
[STC]	Sensitivity Time Control. Remove unwanted echoes near the surface. Use this function when you want to see fish near the surface clearly. Sets the STC value according to your requirement. A setting of [0] disables the STC. Note: A high STC setting can erase fish echoes. It is recommended to watch your display when adjusting the STC.

4. ADVANCED SETTINGS

4.6.2 Calibration menu

The external fish finder settings can be calibrated from the [Calibration] section of the [External Echo Sounder] menu. To calibrate settings for the FCV-38, see section 4.7.5.

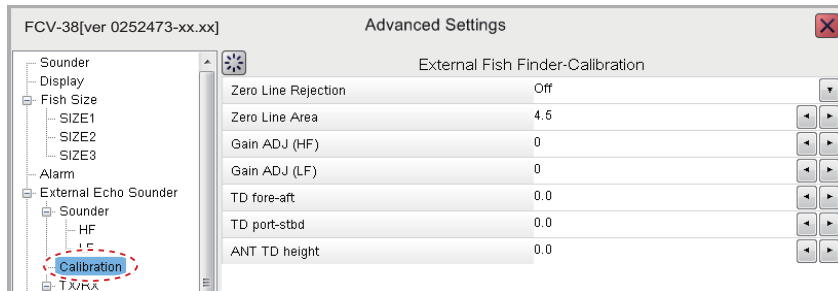

Menu item	Description
[Zero Line Rejector]	Turns the zero line (transmission line) on or off. When turned [On], the transmission line disappears, which allows you to see fish echoes near the surface clearly. The width of the transmission line changes with transducer used and installation characteristics.
[Zero Line Area]	Adjusts the transmission line so that the transmission line disappears when the [Zero Line Rejector] is turned on. For a long tail, increase the value. If the transmission line does not disappear, lower the TX power.
[Gain ADJ (HF)], [Gain ADJ (LF)]	Stabilizes the gain, allowing for a clear picture when the gain is set at a very low/high setting. This function is also helpful in that it balances the gain between HF and LF images.
[TD fore-aft]	Sets the fore-aft position of the external Fish Finder's transducer. This setting is done at installation, do not change this setting.
[TD port-stbd]	Sets the port-stbd position of the external Fish Finder's transducer. This setting is done at installation, do not change this setting.
[ANT TD height]	Sets the height of the Satellite Compass™ antenna above the waterline. This setting is done at installation, do not change this setting.

4.6.3 TX/RX menu

Settings for the external fish finder's transmission can be adjusted from the [TX/RX] section of the [External Echo Sounder]→[Sounder] menu. To adjust the FCV-38 transmission settings, see section 4.7.2.

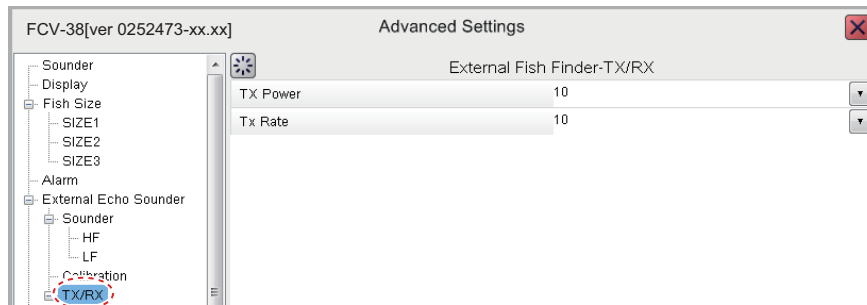

Menu item	Description
[TX Power]	When using more than one fish finder with the same frequency, in close proximity, interference can occur. To reduce the interference, you can reduce the transmission power by lowering this setting. To disable this fish finder, set this setting to [Off]. Depending on the connected fish finder, the settings options are [Off], [1] to [10]. The smaller the number the lower the TX power.
[TX Rate]	Changes the rate at which the fish finder transmits a pulse. Adjust this setting to erase false seabed echoes which may appear between the surface and the actual seabed.

4

HF and LF menus

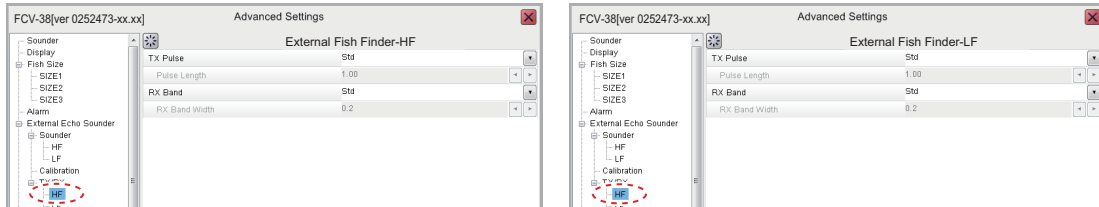

Menu item	Description
[TX Pulse]	Pulse width changes according to range and shift values. However, when long range detection or better resolution is your objective, you can manually adjust the pulse width. the available settings are: <ul style="list-style-type: none"> • [1/4]: Higher resolution, however range is lower than the [1/2] setting. • [1/2]: High resolution, however range is lower then the [Std] setting. • [Std]: Standard (default) setting. Range and resolution are balanced. • [×2]: Higher range than [Std], however resolution is lower. • [Manual]: Adjust the pulse width manually.

4. ADVANCED SETTINGS

Menu item	Description
[Pulse Length]	Available only when [TX Pulse] is set to [Manual]. A low setting gives a higher resolution, however the range is lowered. A high setting give a longer range, however the resolution is lowered.
[RX Band]	Rx bandwidth is automatically set according to [TX Pulse] → [Pulse Length]. The [Normal] setting provides good performance. If noise is a problem switch to [Narrow]. For better resolution, click [Wide]. [Manual] enables manual setting of Rx band width, at [RX Band Width].
[RX Band Width]	Operative when [Manual] is selected at [RX Band]. A small value decreases the noise. On the other hand, a large value gives better resolution.

4.7 System Menu

The [System] menu contains settings which do not require regular adjustment.

4.7.1 Range menu

The Range section of the [System] menu contains range-related settings.

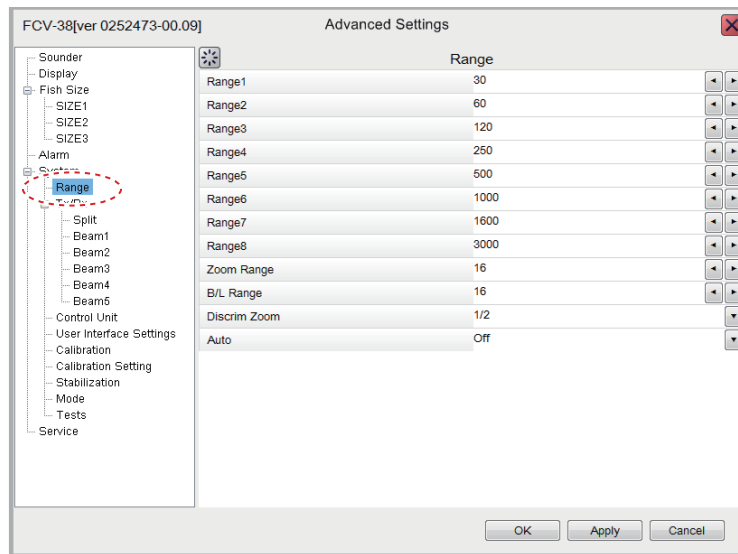

Menu item	Description
[Range1] to [Range8]	Changes the range setting for the preset ranges.
[Zoom Range]	Changes the range at which zoomed items appear on the display.
[B/L Range]	Bottom line range. Change the range for bottom line and bottom discrimination.
[Discrim Zoom]	Sets the room ratio for the Discrimination Zoom function. See section 1.13.4.

Menu item	Description
[Auto]	<p>Click [Auto Range] or [Auto Shift] to enable the respective functions. Click [Off] to disable both [Auto Range] and [Auto Shift].</p> <p>Note 1: Both the [Auto Range] and [Auto Shift] can only be selected individually.</p> <p>Note 2: While [Auto Range] is active, the range indication on the header shows "AT" and the shift indication shows "N/A". Neither range nor shift can be operated manually.</p> <p>Note 3: While [Auto Shift] is active, the shift indication on the header shows "AT". Shift cannot be operated manually. Range can be adjusted.</p>

4.7.2 TX/RX menu

Settings for the FCV-38 can be changed from this menu. For external sounders, see section 4.6.3.

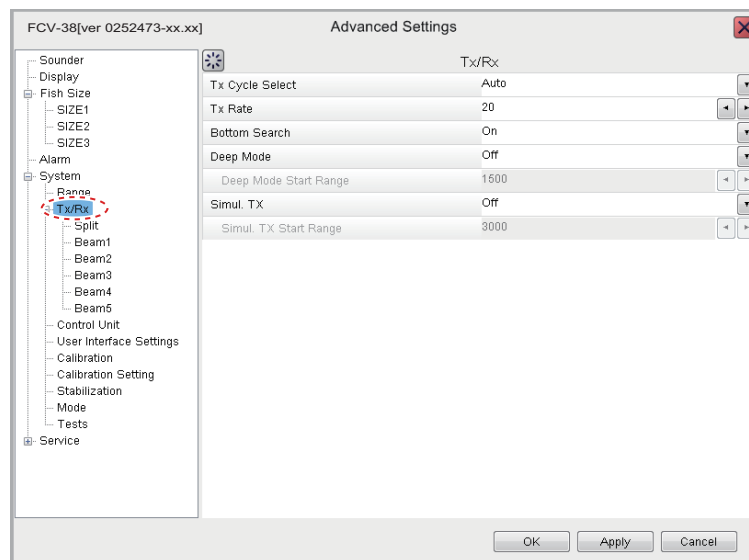

4

Menu item	Description
[TX Cycle Select]	When using more than one fish finder with the same frequency, in close proximity, interference can occur. To display the seabed as best as possible, set this item to [Auto]. Set to [Manual] when interference occurs. Select the setting that suppresses interference.
[TX Rate]	Changes the rate at which the fish finder transmits a pulse. Adjust this setting to erase false seabed echoes which may appear between the surface and the actual seabed in shallow waters. This function is inoperative when [TX Cycle Select] is set to [Manual].
[Bottom Search]	<p>Enables or disables bottom detection. The depth display shows "-.-" when [Bottom Search] is turned off.</p> <p>Note: The following features may not function properly when [Bottom Search] is turned off.</p> <ul style="list-style-type: none"> • Bottom Alarm • Bottom Fish Alarm • Bottom Zoom • Bottom Lock • Bottom Discrimination • Auto Range • Auto Shift • Fish Size Graph (Bottom Trace) • Hardness Graph • Roughness Graph • White Edge • Measurement Range
[Deep Mode]	When the long-distance detection function is turned on, it is possible to measure the fish length to a longer distance than normal. When set to [Auto], the range detection function is automatically turned on when the range is switched over the set value (set by [Deep Mode Start Range] below).

4. ADVANCED SETTINGS

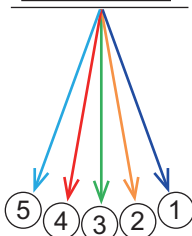
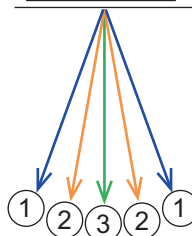
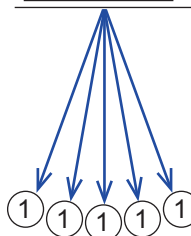
Menu item	Description
[Deep Mode Start Range]	Sets the start range for the [Deep Mode]. When the depth becomes greater than this setting, the [Deep Mode] is enabled (provided [Deep Mode] is set to [Auto]).
[Simul. TX]	<p>Enables or disables simultaneous transmission in the split-beam mode. The screen is drawn faster in this mode, however unwanted echoes (false seabed echoes) may appear.</p> <p>[Off]: Disables simultaneous transmission. (This is called alternating transmission.)</p> <p>[Auto]: If the range is higher than set at [Simul. TX Start Range], all beams are transmitted simultaneously. If the range is lower than the set value, some beams will be transmitted simultaneously depending on the beam direction setting. (This is called semi-simultaneous transmission.) The beams that are transmitting simultaneously can be judged by the color of the beam direction display “figure”. Beams transmitting simultaneously have the same color.</p> <p>[On]: Enables simultaneous transmission.</p> <div style="display: flex; justify-content: space-around; text-align: center;"> <div style="width: 30%;"> <p><u>Alternating transmission</u></p>  <p>Five beams are alternately transmitted</p> </div> <div style="width: 30%;"> <p><u>Semi-simultaneous transmission</u></p>  <p>Some beams are simultaneously transmitted</p> </div> <div style="width: 30%;"> <p><u>Simultaneous transmission</u></p>  <p>Five beams are transmitted in succession</p> </div> </div> <p style="text-align: center;"><i>Beam example: multi-beam 1 - multi-beam 5</i></p>
[Simul. TX Start Range]	Sets the start range for simultaneous transmission, when [Simul. TX] is set to [Auto] or [On].

Split menu

The [Split] menu contains settings for the [Std] and [Deep Mode] (1/2) split-beam displays. The table below shows the values at which the system switches between [Std] and [Deep Mode] (1/2).

The sum of range value and shift value	[Std] and [Deep Mode] (1/2) setting
Range is less than the [Deep Mode Start Range] setting in the [TX/RX] menu.	[Std] settings are used.
Range is greater than the [Deep Mode Start Range] setting in the [TX/RX] menu.	[Deep Mode 1] settings are used.
Range is greater than the [TRX Start Range] setting of [Deep Mode 2] in the [Split] menu.	[Deep Mode 2] settings are used.

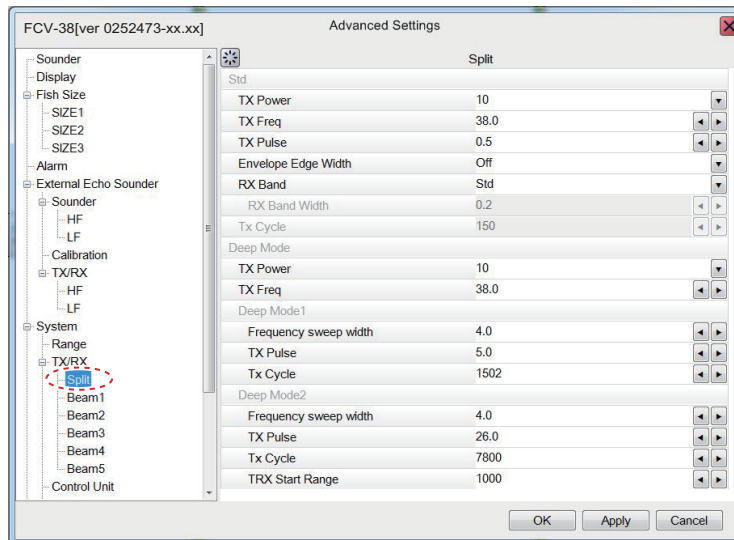

Menu item	Description
[Std]	
[TX Power]	When using more than one fish finder with the same frequency, in close proximity, interference can occur. To reduce the interference, you can reduce the transmission power by lowering this setting. To disable this fish finder, set this item to [Off].
[TX Freq]	Shifts the frequency slightly when interference from other sonars or fish finders occur.
[TX Pulse]	Sets the TX pulse length. A short pulse offers better resolution while longer pulses give better long-range detection.
[Envelope Edge Width]	Suppresses interference to acoustic equipment such as fish finders and scanning sonars, etc. (your own and others).
[RX Band]	Sets the RX band width. The choices are [Narrow], [Std], [Wide], or [Manual].
[RX Band Width]	Set the RX band width manually, when [RX Band] is set to [Manual].
[TX Cycle]	Changes the rate at which the echo sounder transmits a pulse. Adjust this setting to erase false seabed echoes which may appear between the surface and the actual seabed. This item cannot be changed (it is greyed out) when the TX cycle is automatically selected or the TX pulse width is 100 msec or less.
[Deep Mode] (The following items are valid when [Deep Mode] in the [TX/RX] menu is set to [Auto].)	
[TX Power]	When using more than one fish finder with the same frequency, in close proximity, interference can occur. To reduce the interference, you can reduce the transmission power by lowering this setting. To disable this fish finder, set this setting to [Off].
[TX Freq]	Sets the TX frequency. Shift the frequency slightly when interference from other sonars or fish finders occur.
[Deep Mode 1]	[Frequency Sweep Width]: Frequency sweeping (modulating the frequency around the center frequency) makes the echo sounder less susceptible to noise and makes it easier to detect long distances. If the sweep width is too wide, the frequency range to be used is widened, making the sounder susceptible to interference with other equipment. [TX Pulse]: Set the TX pulse length. A short pulse offers better resolution while longer pulses give better long-range detection [TX Cycle]: If interference appears on the display, adjust this item to reduce the interference.

4. ADVANCED SETTINGS

Menu item	Description
[Deep Mode 2]	See [Deep Mode 1] for description of [Frequency Sweep Width], [TX Pulse] and [TX Cycle]. [TRX Start Range]: Sets the depth at which to start the deep mode in [Deep Mode 2]. Inoperative when simultaneous transmission by multiple beams is turned off.

Beam1 - Beam 5 menus

The [Beam 1] menu has the settings for "Std" and "Deep Mode" for beam 1. ("Beam 2" to "Beam 5" contain the same items. The table below shows the values at which the system switches between [Std] and [Deep Mode].

The sum of range value and shift value	[Std] and [Deep Mode] setting
Range is less than the [Deep Mode Start Range] setting in the [TX/RX] menu.	[Std] settings are used.
Range is greater than the [Deep Mode Start Range] setting in the [TX/RX] menu.	[Deep Mode] settings are used.

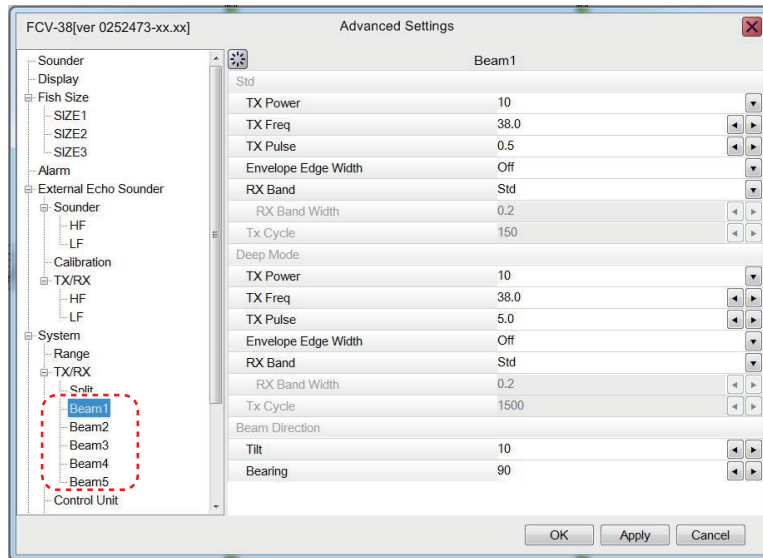

Menu item	Description
[Std]	
[TX Power]	When using more than one fish finder with the same frequency, in close proximity, interference can occur. To reduce the interference, you can reduce the transmission power by lowering this setting. To disable this fish finder, set this setting to [Off]. To display the seabed as best as possible, set the power level to [Auto]. Set the TX frequency to use.
[TX Freq]	Sets the TX frequency. Shift the frequency slightly when interference from other sonars or fish finders occur.
[TX Pulse]	Set the transmission pulse width (setting range: 0.3 to 26.0 * msec). The smaller the value, the higher the detection resolution, but the shorter the detection distance. On the other hand, increasing the value lowers the detection resolution, but increases the detection distance. * When [Simul. TX] in the [TX/RX] menu is set to [Auto] or [On], the maximum TX pulse length is 5.0.
[Envelope Edge Width]	Suppresses interference to acoustic equipment such as fish finders and scanning sonars, etc. (your own and others).

Menu item	Description
[RX Band]	The RX band width is automatically set according to the TX pulse length. To reduce noise, use [Narrow]. For increased resolution, use [Wide]. To set the RX band width manually, select [Manual].
[RX Band Width]	Sets the RX band width manually, when [RX Band] is set to [Manual].
[TX Cycle]	Sets how often to transmit pulses. Valid when [TX Cycle Select] in the [TX/RX] menu is set to [Manual]. Adjust the TX cycle setting when low-level interference appears on the display.
[Deep Mode] (The items other than [TX Cycle] are valid when [Deep Mode] in the [TX/RX] menu is set to [Auto].)	
[TX Power]	When using more than one fish finder with the same frequency, in close proximity, interference can occur. To reduce the interference, you can reduce the transmission power by lowering this setting. To disable this fish finder, set this setting to [Off]. To display the seabed as best as possible, set the power level to [Auto].
[TX Freq]	Sets the TX frequency. Shift the frequency slightly when interference from other sonars or fish finders occur.
[TX Pulse]	Set the transmission pulse width (setting range: 0.3 to 26.0 * msec). The smaller the value, the higher the detection resolution, but the shorter the detection distance. On the other hand, increasing the value lowers the detection resolution, but increases the detection distance. * When [Simul. TX] in the [TX/RX] menu is set to [Auto] or [On], the maximum TX pulse length is 5.0.
[Envelope Edge Width]	Suppresses interference to acoustic equipment such as fish finders and scanning sonars, etc. (your own and others).
[RX Band]	The RX band width is automatically set according to the TX pulse length. To reduce noise, use [Narrow]. For increased resolution, use [Wide]. To set the RX band width manually, select [Manual].
[RX Band Width]	Sets the RX band width manually, when [RX Band] is set to [Manual].
[TX Cycle]	Sets how often to transmit pulses. Valid when [TX Cycle Select] in the [TX/RX] menu is set to [Manual]. Adjust the TX cycle setting when low-level interference appears on the display.
[Beam Direction]	
[Tilt]	Sets the tilt angle.
[Bearing]	Sets the bearing.

4. ADVANCED SETTINGS

4.7.3 Control unit menu

The [Control Unit] menu provides settings for the Trackball Control Unit.

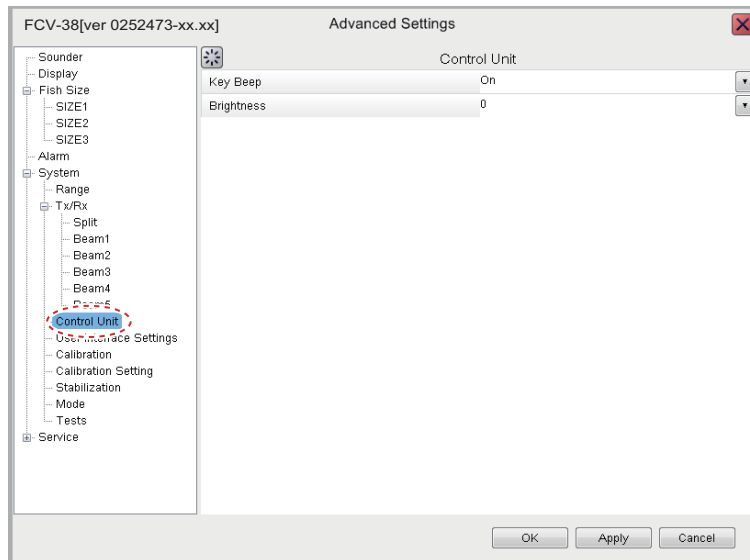

Menu item	Description
[Key Beep]	Sets to [On] or [Off] to enable or disable the key beeps.
[Brightness]	Adjusts the brightness for the Trackball's power LED and the back-light for the power button.

4.7.4 User Interface Settings menu

You can change the language, units used for measurement, screenshot settings, etc.

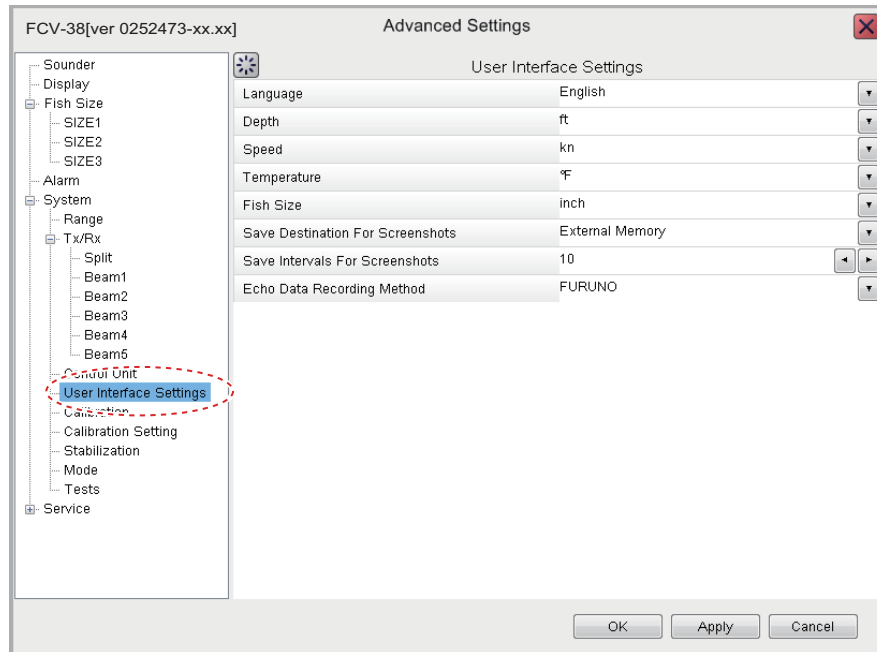

Menu item	Description
[Language]	Selects the language to display the menus and on-screen indications in.
[Depth]*	Selects the unit of measurement for depth.
[Speed]	Selects the unit of measurement for speed.
[Temperature]*	Selects the unit of measurement for temperature.
[Fish Size]*	Selects the unit of measurement for fish size.
[Save Destination For Screenshots]	Selects the save destination for screenshots. See section 3.1.1.
[Save Intervals For Screenshots]	Selects the interval timing for taking repeated screenshots. section 3.1.3.
[Echo Data Recording Method]	Selects the data format to use to record echo data. For details see section 3.2.1.

* Whenever a unit of measurement is changed, the message shown below appears. If you are sure to proceed, click the [Yes] button.

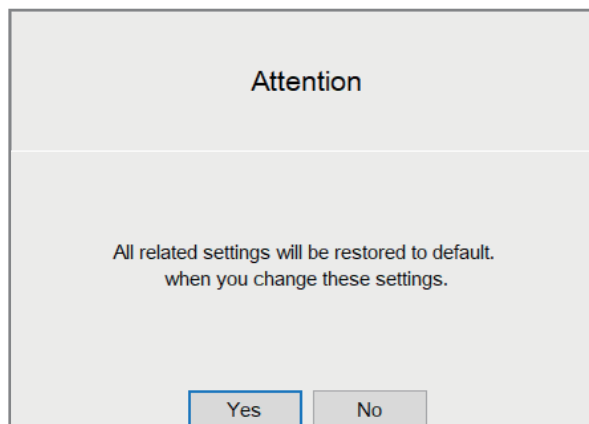

4. ADVANCED SETTINGS

4.7.5 Calibration menu

You can calibrate (offset) the water temperature and other information from this menu.

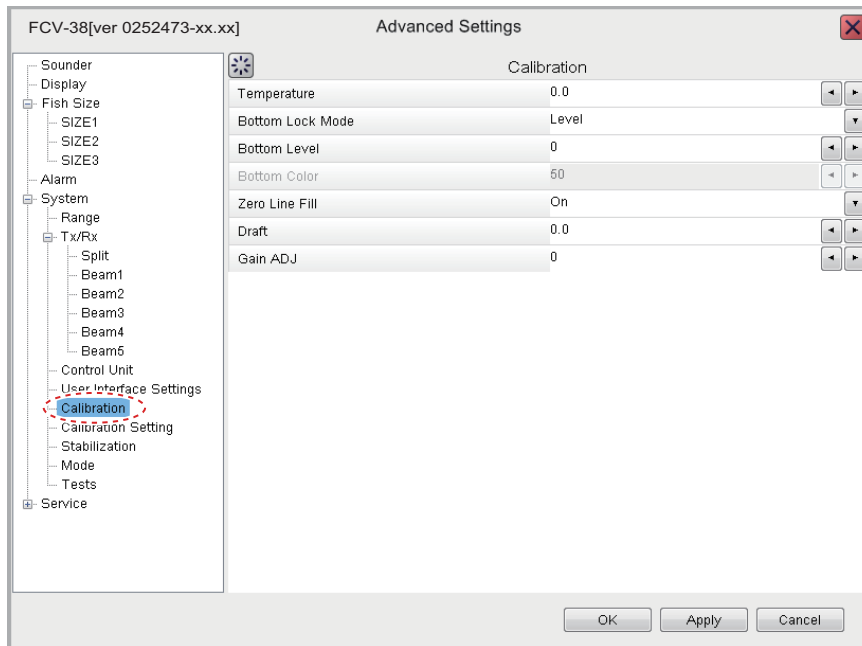

Menu item	Description
[Temperature]	If the water temperature indication is wrong, you can correct it here. For example, if the actual temperature is 2°C higher than the temperature displayed on screen, set the offset to [+2°C].
[Bottom Lock Mode]	Set how the bottom edge is determined, by signal level or display color. <ul style="list-style-type: none"> • [Level]: Determine the bottom edge by signal level. When the method is [Color], bottom fish may be hidden in the bottom edge. With [Level] the shape of the bottom echo may change depending on the bottom contour of the bottom. • [Color]: Determine the bottom edge by display color. When bottom fish are well separated from the bottom, the bottom is displayed with a straight line, making discrimination of bottom fish easier. However, the bottom presentation may change depending on gain setting.
[Bottom Level]	In the default bottom level setting [0], the equipment judges consecutive strong echoes to be bottom echoes. If, in that setting, the depth indication is unstable, adjust the bottom level. If vertical lines extend upward from the bottom echo in the bottom lock display, lower the bottom level to erase the vertical lines. If the level is too low, however, it may be difficult to distinguish bottom fish from the bottom echo.
[Bottom Color]	When [Bottom Lock Mode] is set to [Color], you can select the color (0-63) to be judged as the bottom echo.
[Zero Line Fill]	Turn off to see fish echoes near the surface.
[Draft]	The default depth display shows the distance from the transducer. If you would rather show the distance from the sea surface, set your ship's draft. The draft line for HF and LF can be set respectively.
[Gain ADJ]	If the gain is too high or too low, or the gain for the low and high frequencies appears unbalanced, you can compensate it here.

4.7.6 Calibration Settings menu

The [Calibration Settings] menu calibrates the FCV-38 system. For further details see section 5.4.

4.7.7 Stabilization menu

The [Stabilization] section of the [System] menu mainly compensates for heaving. See the Notes below to enable use of this function.

Note 1: This function requires connection to a Satellite Compass™. If data from the compass is lost or interrupted, the function is disabled.

Note 2: To use stabilization, set output data on the Satellite Compass™ as shown below. See the operator’s manual for the Satellite Compass™.

- Output sentence: ATT (GPatt), HVE (GPhe)
- Baud rate: 38,400 bps
- Output interval: 25 ms or less
- Version (SC-50/110 only): IEC ED1

Note 3: This function is unavailable if [KP Input] is set to [On] at installation.

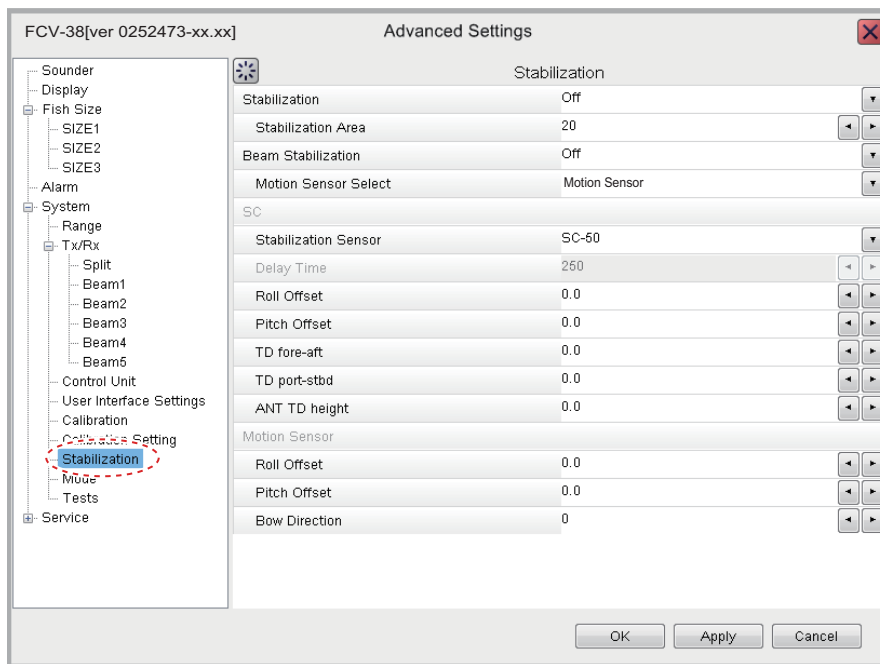

Menu item	Description
[Stabilization]	<p>Turns heaving compensation on or off. Turn it on when seas are rough, to get stable echoes, regardless of sea conditions. When turned on, the stabilization icon () appears in the [Picture Advance] section of the header.</p> <p>Note: Where data from the Satellite Compass™ is interrupted or lost, the stabilization icon is overlaid with a cross to indicate that it is not in use. When data from the Satellite Compass™ is received again, the cross is removed.</p>

4. ADVANCED SETTINGS

Menu item	Description
[Stabilization Area]	When heaving exceeds the value set here, stabilization is stopped and the stabilization icon at the top of the screen is displayed with an "X", indicating it has stopped. However, the setting for [Stabilization] is kept [On]. When heaving is once again less than the value set here, stabilization is restarted and the "X" disappears.
[Beam Stabilization]	Set to [On] to enable the beam stabilization function, via the motion sensor inside the unit or the Satellite Compass™.
[Motion Sensor Select]	Selects the motion sensor to be used. [Motion Sensor]: Use the internal motion sensor. [SC]: Use the Satellite Compass™.
SC (Satellite Compass)	
[Stabilization Sensor]	Selects the Satellite Compass™ model connected to the FCV-38.
[Delay Time]	Set at installation. Available only when [Stabilization Sensor] is set to [Manual]. Do not change this setting.
[Roll Offset]	If the roll indication appears to be wrong you can compensate for the difference here. Enter a positive value if the indication is lower than actual, or enter a negative value if the indication is higher than actual. For example if the indication is 1° but the actual value is 2°, enter "+1".
[Pitch Offset]	If the pitch indication appears to be wrong you can compensate for the difference here. Enter a positive value if the indication is lower than actual, or enter a negative value if the indication is higher than actual. For example if the indication is 2° but the actual value is 1°, enter "-1".
[TD fore-aft]	Set at installation. Indicates the location and height of the Satellite Compass™ antenna. Do not change these settings.
[TD port-stbd]	
[ANT TD height]	
[Motion Sensor] (Below settings are valid when [Motion Sensor Select] is selected to [Motion Sensor]).	
[Roll Offset]	If the roll indication appears to be wrong you can compensate for the difference here. For example, if the internal motion sensor is tilted to the port side, enter a minus value.
[Pitch Offset]	If the pitch indication appears to be wrong you can compensate for the difference here. For example, if the internal motion sensor is tilted to the bow, enter a minus value.
[Bow Direction]	Enter the number of degrees the internal motion sensor is positioned from the bow. For example, if the transceiver unit is installed with its front panel facing port side, the internal motion sensor is directed toward the bow. If the front panel is directed toward the bow, enter "90°".

4.7.8 Mode menu

You can "split" the display screen from the [Mode] section of the [System] menu. This allows you to display different information across two or more sections of the display.

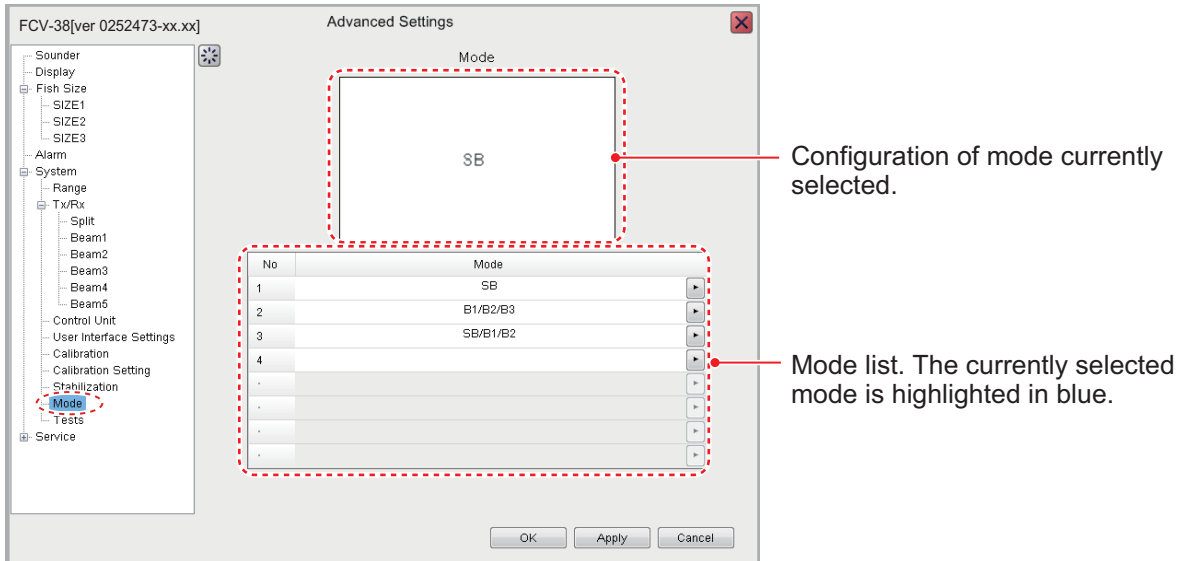

How to add a mode

You can have a maximum of eight modes. To add a mode, do the following:

1. With the [Mode] menu displayed, click the applicable (▾) button of an empty mode number. The screen should look something like the one shown below.

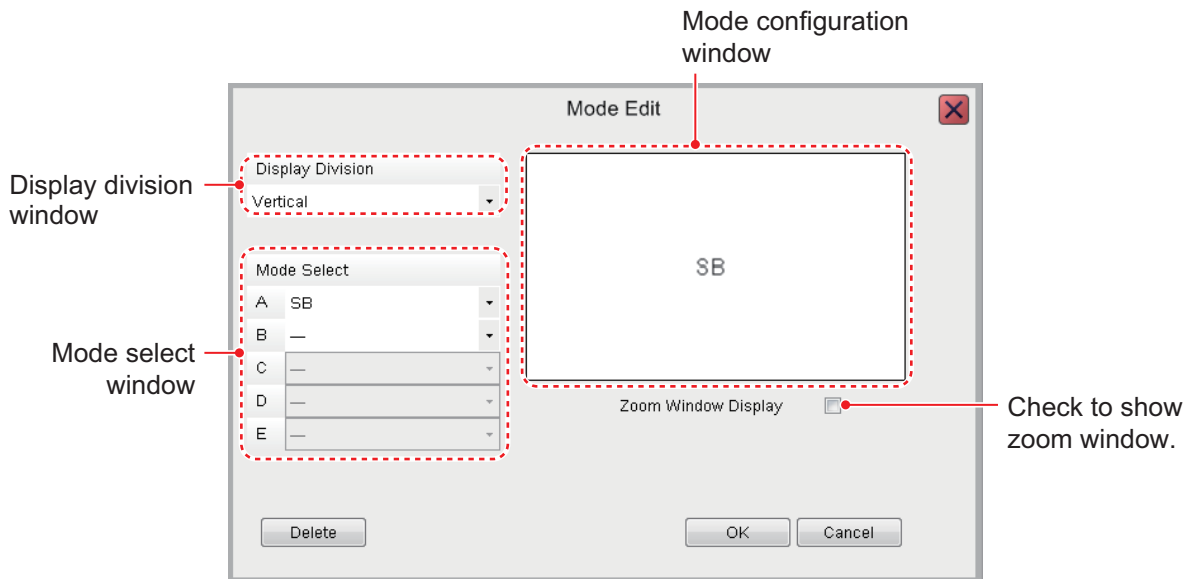

2. For two or more screens in a mode, select the desired display orientation from the [Display Division] drop-down list. The choices are [Vertical], [Horizontal] and [Complex]. See Appendix 2 for the layout available with each screen division.
3. From the [Mode Select] window, select up to five items to display on the mode selected. The choices are outlined in the table below.

4. ADVANCED SETTINGS

[Mode Select] window items

[Mode Select] window items	Description
[---]	No selection.
[SB]	Split Beam display.
[B1] - [B5]	Beams 1 through 5.
[ZM] ^{*1}	Zoom display for split beam.
[HE] ^{*2}	External sounder's high frequency display.
[LE] ^{*2}	External sounder's low frequency display.

^{*1} [ZM] is selectable after selecting [SB]. Also not displayed when the [Zoom Window Display] checkbox is checked.

^{*2} Displayed only when [External Fish Finder Window] is set to [Off] at installation.

4. To add the zoom window display to a mode, check the [Zoom Window Display] checkbox. The zoom window display is not available when SB is selected at step 3. The same applies to when [ZM] is selected.
5. Click [OK] to apply the changes to the mode selected at step 1 and close the menu. Click [Cancel] to cancel any changes made and close the menu.

How to edit a mode

You can edit the contents of a display mode at any time. To edit a mode, do the following:

Note: Display modes cannot be edited while echo data is being recorded in NetCDF4 format.

1. With the [Mode] menu displayed, select the display mode you wish to edit, from the Mode list, with the applicable () button.
2. Use the [Mode Select] and [Display Division] windows to edit the mode as required.
3. Click [OK] to apply the changes and close the menu. Click [Cancel] to cancel any changes made and close the menu.

How to delete a mode

1. With the [Mode] menu displayed, select the display mode you wish to edit, from the Mode list, with the applicable () button.
2. Click the [Delete] button at bottom-left side of the screen to delete selected mode.

4.7.9 Tests menu

Maintenance information, diagnostic tests and other tools are found in the [Tests] menu of the [System] menu. For details, see section 6.7.

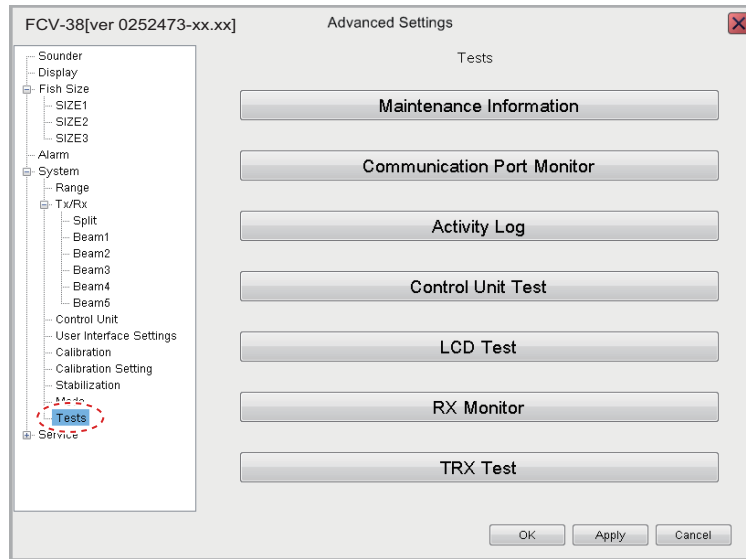

4.8 External Fish Finder

The external fish finder's settings can be adjusted from the sub display. To access the external fish finder settings, right-click a non-interactive section of the screen.

4.8.1 Sounder menu

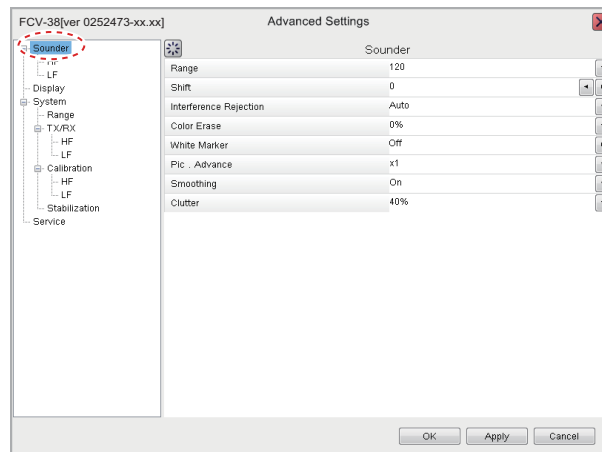

Menu item	Description
[Range]	Sets how many meters from the transducer to show underwater objects on the screen. See section 1.9.
[Shift]	Moves the current display range up or down to view shallow or deep objects more easily. section 1.8.
[Interference Rejection]	Rejects noise and interference from other equipment on-board. See section 1.10.
[Color Erase]	Removes unnecessary noise from the screen by color. See section 1.26.

4. ADVANCED SETTINGS

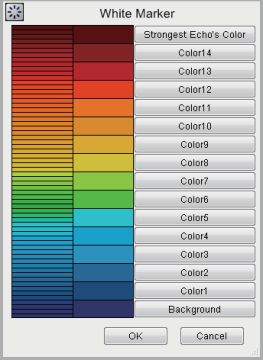
Menu item	Description
[White Marker]	<p>Emphasizes schools of fish or seabed in white color.</p> <ol style="list-style-type: none"> 1) Click the () button to show the [White Marker] setting window. 2) Click the applicable "color" button to select the color to show in white. 3) Click the [OK] button to finish, or the [Cancel] button to escape. 
[Pic. Advance]	Selects the speed at which to advance the echo sounder picture. See section 1.6.
[Smoothing]	Smooths the video display. See section 1.11.
[Clutter]	Removes "speckles" from the screen emphasize schools of fish. See section 1.12.

HF and LF menus



Menu item	Description
[Gain]	Adjusts the gain. See section 1.7.
[TVG Level]	Sets the long distance gain. See section 1.27.
[STC]	Removes noise (bubbles, plankton, etc.) near the surface. "0" turns off the STC function, and "10" removes noise up to 5 m from the transducer surface. Be careful not to set the level excessively high, to prevent erasure of schools of fish.

4.8.2 Display menu

You can adjust the display settings for the external fish finder from the [Display] menu of the [External Fish Finder] menu.

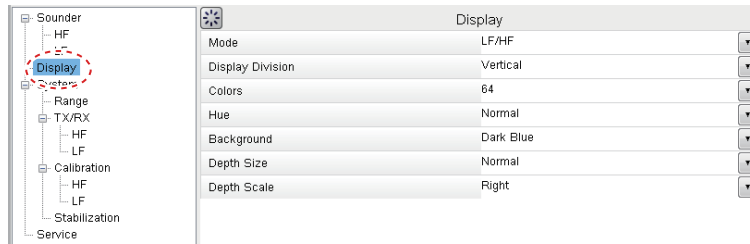

Menu item	Description
[Mode]	Selects the display mode for the external fish finder. <ul style="list-style-type: none"> [HF/HF]: High and Low frequency. [HF]: High frequency only. [LF]: Low frequency only.
[Display Division]	Selects the method in which the display is divided. This option is only available when [Mode] is set to [HF/LF]. <ul style="list-style-type: none"> [Horizontal]: The dividing line runs horizontally (left to right) and the display shows high frequency input at the top of the screen. [Vertical]: The dividing line runs vertically (top to bottom) and the display shows high frequency input to the left of the screen.
[Colors]	Selects the number of colors (16 or 64) available for the [Color Bar] and echo colors.
[Hue]	Selects a hue to suit the ambient light. <ul style="list-style-type: none"> [Normal]: Use the default hue settings. [Hue1] to [Hue6]: Use the custom hue settings for the respective selection.
[Background]	Selects the background color for the display. Some indications will automatically change color according to the color selected here. Valid when Hue is selected to other than [Hue5].
[Depth Size]	Selects the size of the depth text indication.
[Depth Scale]	Selects where to locate the depth scale. <ul style="list-style-type: none"> [Off]: Hide the depth scale. [Right]: Show the scale at the far right-hand side of the screen. [Center]: Show the scale at the center of the screen.

4.8.3 Measurement menu

The [Measurement] menu appears when an ACCU-FISH™ compatible transducer is connected. See section 1.21.2.

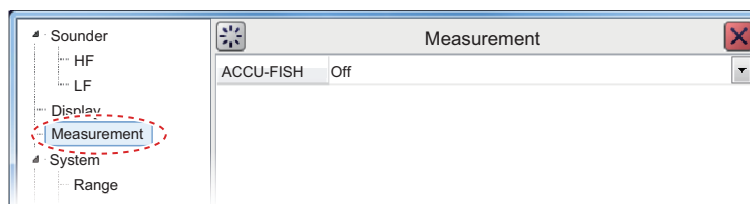

4. ADVANCED SETTINGS

4.8.4 System menu

The [System] menu contains settings for items which do not require regular adjustment or change.

Range menu

Change any of the eight available the preset ranges.

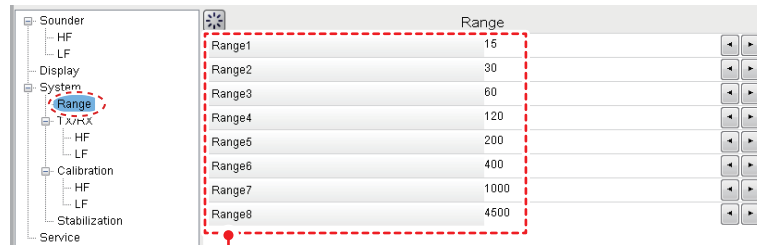

Range presets for external fish finder

[Range 1] to [Range 8] can be adjusted to suit your preferences.

TX/RX menu

The [TX/RX] menu contains settings for pulse transmission and receipt. Depending on your vessel's configuration, some menu items may not be available. See the lists below for more details.



Menu item	Description
[TX Power]	Adjusts the output power of the transducer. Where fish finders or other equipment causes interference, you can adjust the output power level to help reduce, or eliminate, the interference. You can also disable transmission completely by selecting the [Off] option. The setting options are [Off], [1] to [10]. *: Select [Auto] to automatically adjust the transmission power, which produces higher quality seabed echoes.
[TX Rate]	Adjusts the transmission rate for the transducer. When in shallow waters second reflection echoes may appear between the surface and actual bottom echo. In this case, lower the TX rate level. Use a high rate for fast speed; a slow rate for slow speed.

HF and LF menus

Note: See the table below for menu items and descriptions:

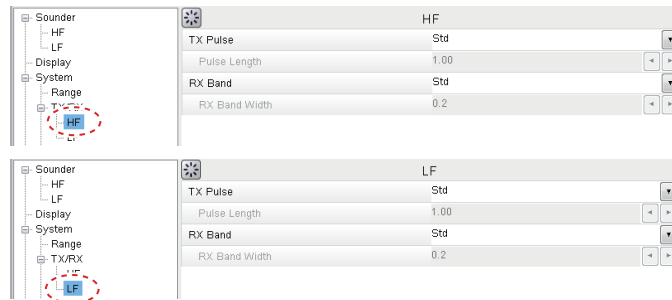

Menu item	Description
[TX Pulse]	Pulse width changes according to range and shift values. However, when long range detection or better resolution is your objective, you can manually adjust the pulse width. the available settings are: <ul style="list-style-type: none"> • [1/4]: Higher resolution, however range is lower than the [1/2] setting. • [1/2]: High resolution, however range is lower then the [Std] setting. • [Std]: Standard (default) setting. Range and resolution are balanced. • [x;2]: Higher range than [Std], however resolution is lower. • [Manual]: Adjust the pulse width manually.
[Pulse Length]	Available only when [TX Pulse] is set to [Manual]. A low setting gives a higher resolution, however the range is lowered. A high setting give a longer range, however the resolution is lowered.
[RX Band]	Rx bandwidth is automatically set according to [TX Pulse] → [Pulse Length].The [Normal] setting provides good performance. If noise is a problem switch to [Narrow]. For better resolution, select [Wide]. [Manual] enables manual setting of Rx band width, at [RX Band Width].
[RX Band Width]	Operative when [Manual] is selected at [RX Band]. A small value decreases the noise. On the other hand, a large value gives better resolution.

4. ADVANCED SETTINGS

Calibration menu

Use the Calibration menu to apply offsets for the external fish finder.

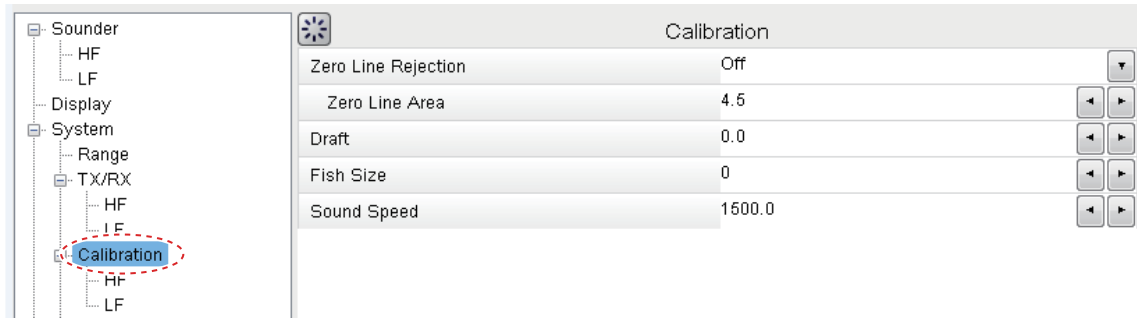

Menu item	Description																
[Zero Line Rejection]	Turns the zero line (transmission line) on or off. When turned [On], the transmission line disappears, which allows you to see fish echoes near the surface clearly. The width of the transmission line changes with transducer used and installation characteristics.																
[Zero Line Area]	Adjusts the transmission line so that the transmission line disappears when the [Zero Line Rejector] is turned on. For a long tail, increase the value. If the transmission line does not disappear, lower the TX power.																
[Draft]	The default depth display shows the distance from the transducer. If you would rather show the distance from the sea surface, set your ship's draft. The draft line for HF and LF can be set respectively.																
[Fish Size]	Compensates for incorrect fish size indications as shown in the table below. <table border="1" style="margin: 10px auto;"> <thead> <tr> <th>Setting (%)</th> <th>Size of correction</th> <th>Setting (%)</th> <th>Size of correction</th> </tr> </thead> <tbody> <tr> <td>+100%</td> <td>times 2</td> <td>-65%</td> <td>1/3</td> </tr> <tr> <td>+50%</td> <td>times 1.5</td> <td>-75%</td> <td>1/4</td> </tr> <tr> <td>-50%</td> <td>1/2</td> <td>-80%</td> <td>1/5</td> </tr> </tbody> </table>	Setting (%)	Size of correction	Setting (%)	Size of correction	+100%	times 2	-65%	1/3	+50%	times 1.5	-75%	1/4	-50%	1/2	-80%	1/5
Setting (%)	Size of correction	Setting (%)	Size of correction														
+100%	times 2	-65%	1/3														
+50%	times 1.5	-75%	1/4														
-50%	1/2	-80%	1/5														
[Sound Speed]	Adjusts the sound velocity of the TX/RX signal if the depth indication is incorrect, often caused by water temperature or salinity.																

HF and LF menus

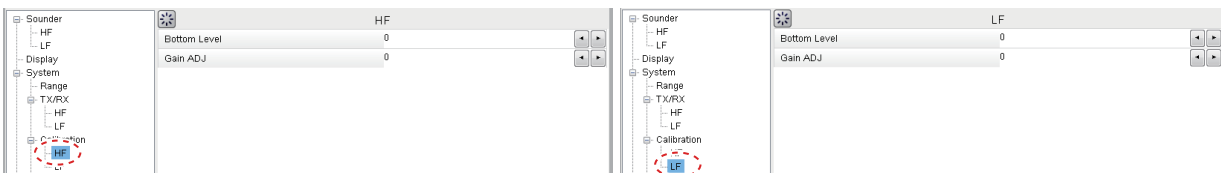

Menu item	Description
[Bottom Level]	In the default bottom level setting [0], the equipment judges consecutive strong echoes to be bottom echoes. If, in that setting, the depth indication is unstable, adjust the bottom level. If vertical lines extend upward from the bottom echo in the bottom lock display, lower the bottom level to erase the vertical lines. If the level is too low, however, it may be difficult to distinguish bottom fish from the bottom echo.
[Gain ADJ]	If the gain is too high or too low, or the gain for the low and high frequencies appears unbalanced, you can compensate it here.

Stabilization menu

You can adjust for heave on the external fish finder from the [Stabilization] menu. This function requires connection to a Satellite Compass™ and becomes inactive if data from the Satellite Compass™ is interrupted or lost.

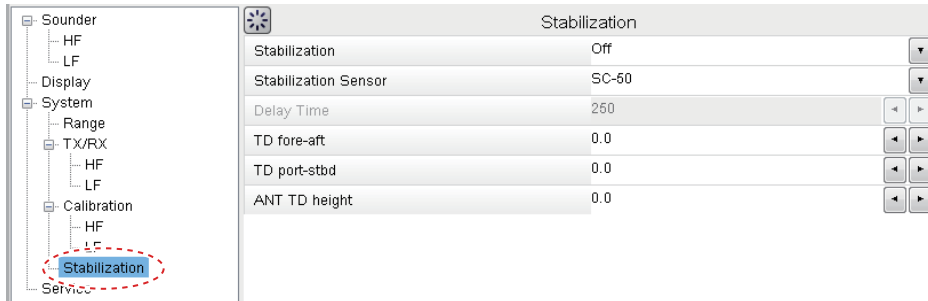

Menu item	Description
[Stabilization]	Turns heaving compensation on or off. To get stable seabed echoes regardless of sea conditions, turn [Stabilization] on when seas are rough.
[Stabilization Sensor]	Set at installation. Indicates the Satellite Compass™ connected to the FCV-38. Do not change this setting.
[Delay Time]	Set at installation. Available only when [Stabilization Sensor] is set to [Manual]. Do not change this setting.
[TD fore-aft], [TD port-stbd], [ANT TD height]	Set at installation. Indicates the location and height of the Satellite Compass antenna. Do not change these settings.

4. ADVANCED SETTINGS

This page is intentionally left blank.

5. CALIBRATION

This chapter contains the procedures for calibrating the system.

5.1 Overview

Calibration is mandatory for acoustic resource surveys. In order to improve data accuracy, calibrate the unit with a standard sphere. The purpose of the standard sphere is to calibrate the TX and RX sensitivity of the entire system. The sensitivity correction value is found by measuring the target strength (TS) and theoretical TS of a known target (standard sphere) on the open sea. The difference between the target strength and TS is the sensitivity correction value. Defining TX and RX sensitivity as the sum of the source level and the receiver sensitivity (in dB), the sensitivity correction value is equal to the TX and RX sensitivity minus its default value. Sensitivity measurements taken during the Calibration mode (hereafter referred to as "CAL mode") are stored, along with the source level and decibels, as a sonar data file. These measurements allow you to ascertain the TX and RX sensitivity at the time of data recording.

5.2 Preparation

5.2.1 Necessary parts

Name	Qty	Remarks
Standard sphere	1	
Fishing rod	3	
Rod mount	3	
Fishing reel	3	With fishing line capacity of approx. 100 m
Fishing line	1	Nylon mono-filament, line weight 15
Weight	2	Fishing type, #150
Rope for passing fishing line under hull	Approx. 40 m*	φ8 - 10 * Approx. length for 400 ton vessel
Surface-activating agent	Suitable quantity	Dishwashing liquid can also be used.
Bucket	1	
CTD (Conductivity Temperature Depth) profiler	1	Water temperature gauge can be used.
Walkie-talkie	1	Ship's public address system can also be used.

A minimum of four persons (control the fishing line; operate the PC software) are required for the calibration. In addition, persons for anchorage and ship handling are also necessary.

5.2.2 How to bind the standard sphere

Bind the standard sphere with the fishing line as shown in the figure below. The length on the side of the triangle is as follows.

- 38.1 mm diameter standard sphere: L=30 mm
- 47.625 mm diameter standard sphere: L=37 mm

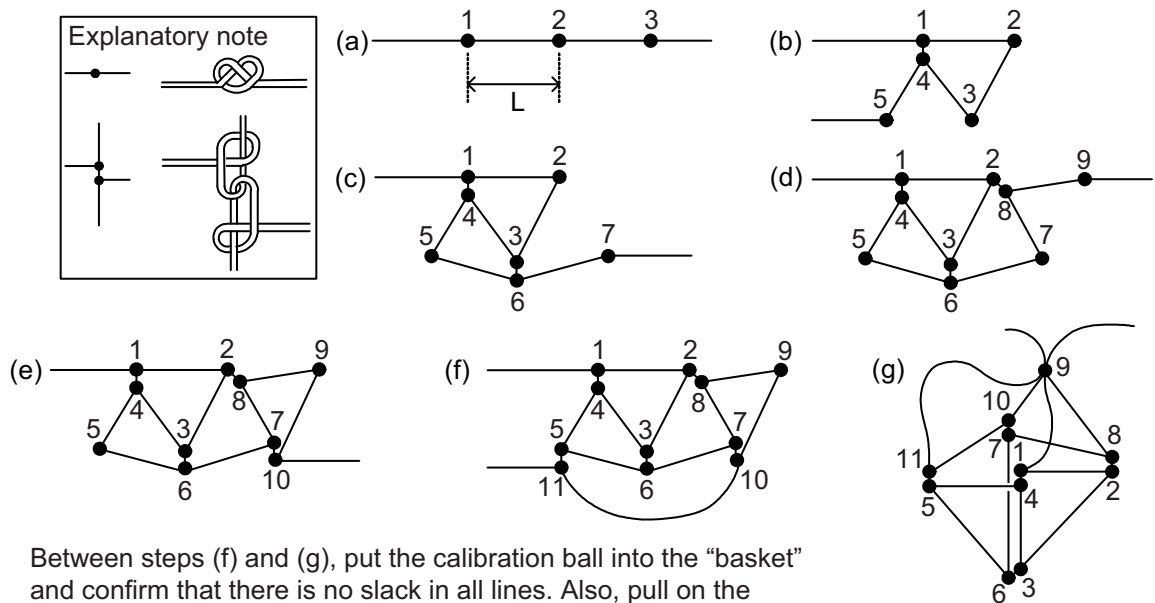
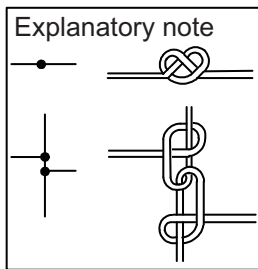

Between steps (f) and (g), put the calibration ball into the “basket” and confirm that there is no slack in all lines. Also, pull on the calibration ball to confirm that it is tightly fastened.

5.2.3 How to select the measurement area

Select the measurement area, considering the following points. An unsuitable region will affect data accuracy.

NOTICE

Do not do the calibration in an area where there are many fish.

Too many fish can decrease data accuracy. Also, avoid areas known for puffer fish, as they can cut fishing lines.

- Do the measurement inside a bay with no waves, winds, or tidal current.
- The bottom should be comparatively flat, and the depth at least 30 m (ideally, more than 50 m).
- The water should be transparent (less living objects).
- The area should be free of other vessels.
- Select an area free of fishing facilities.

The most suitable time to do the calibration is when the tide subsides at daytime. The lull in the morning and early-evening are also suitable. Nighttime is not suitable because plankton rise to the surface and the light from the ship attracts fish.

5.3 How to Set the Calibration Tools

5.3.1 How to set the fishing rod

Set the rod mounts and fishing rods, referring to the figure "Mounting location for fishing rods" for their locations and the two mounting precautions noted below.

- Make the triangle connecting fishing rods 1, 2, and 3 as close as possible to an equilateral triangle.
- Install the transducer so that it is on the straight line connecting the midpoint of fishing rods 2 and 3 to 1.

Note: The location shall have no interfering objects between the transducer and the standard sphere.

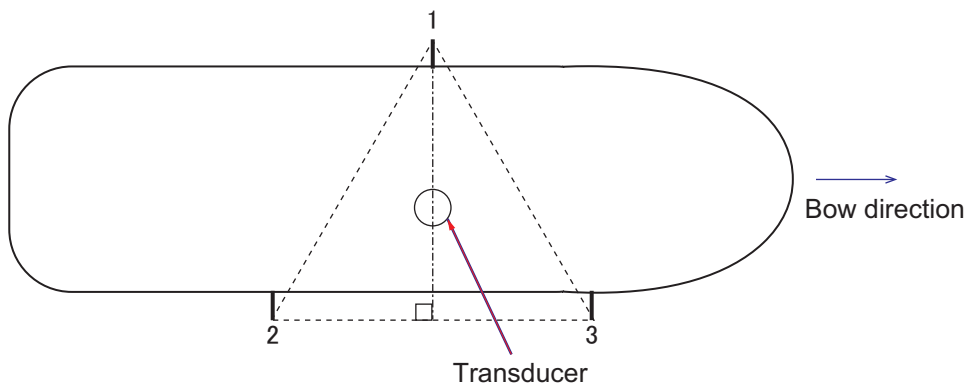

Mounting location for fishing rods

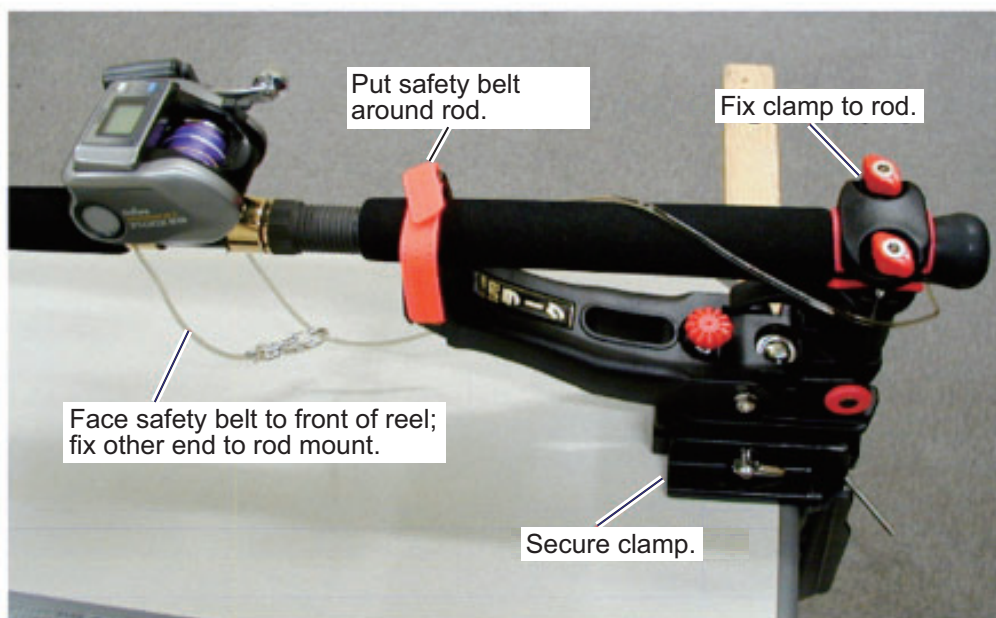

How to set fishing rod to rod mount

Note: If the position is determined from the ship's general layout diagram or the like, it is recommended to mark the position on the hull (paint, etc.) for ease of positioning in future surveys.

5.3.2 How to swing rope under the ship bottom

Once you have selected a calibration location, stop the ship. In order to place the standard sphere underneath the hull bottom, a rope is swung under the hull bottom near the bow of the ship bottom before anchoring. The reason that the rope is crossed under the bottom of the boat (instead of the fishing line) is that the rope is easier to handle than the fishing line from the rod, and the fishing line is more likely to be caught by a protrusion on the hull.

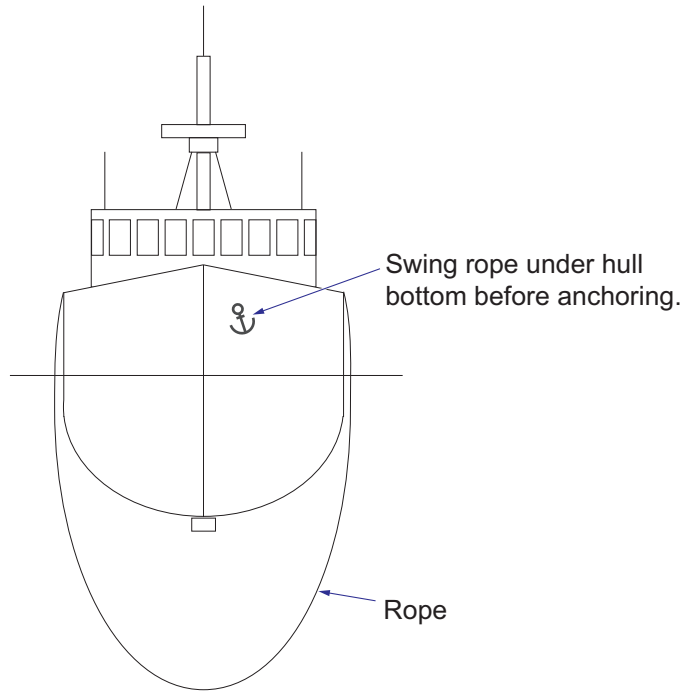

Note: Attaching weights (such as a shackle) to the rope makes the rope easier to work with. If three weights are attached to the center, left and right at intervals of the ship width, as shown in the figure below, the rope can easily be swung under the hull because the rope stays vertical. This is especially effective for ships with a bulbous bow.

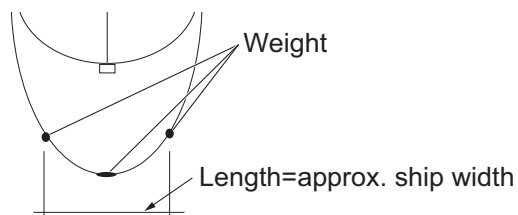

5.3.3 How to set the standard sphere

⚠ CAUTION

⚠ Handle the standard sphere with care, keeping in mind the following points.

- **Do not drop the sphere.**
Bodily injury or damage to the sphere and ship can result.
- **Do not swing the rod attached to the sphere.**
Bodily injury or damage to the sphere and ship can result if the line breaks.
- **Do not coat the sphere with oil nor allow it to rust or become soiled.**
Oil, rust or foreign material on the sphere may affect measurement accuracy.

Follow the procedure below to set the standard sphere.

1. With the rope under the ship's hull, drop the anchor.
2. Attach the fishing line to the end of the rope on the side where only one fishing rod is placed (see the figure on page 5-3, #1 fishing rod). Pull the rope from the other side so the fishing line crosses the bow. To ensure that the fishing line flows freely, check that the drag on the fishing rod is off.

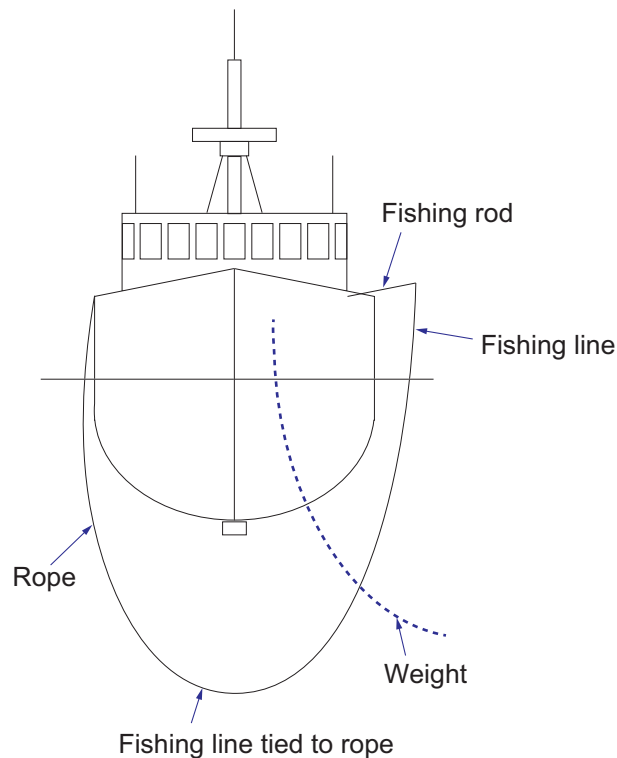

Note: The reason the rope is crossed from the side where only one fishing rod is placed is to prevent tension from being applied to the standard sphere (and the weight in some cases) when the sphere is suspended.

5. CALIBRATION

3. Tie the fishing lines of the remaining two fishing rods to the standard sphere. Use a "figure-eight" knot to tie the fishing lines.

Note: Do not use a joining tool like a swivel.

4. If the tide speed is high and it is difficult to tie the standard sphere, attach a weight below the standard sphere. Install the weight at least 10 m away from the sphere.
5. Put seawater and surface-activating agent into the bucket.
6. Soak the standard sphere in the solution prepared at step 5 to prevent air bubbles and dirt from adhering to the sphere. Avoid touching the sphere as much as possible.
7. Lower the standard sphere to the bottom of the ship, being careful not to tangle the fishing line. During the lowering, be careful not to apply tension to the fishing line of the #1 fishing rod. Also, be careful not to rub the fishing line of the #1 fishing rod against the bottom of the boat.

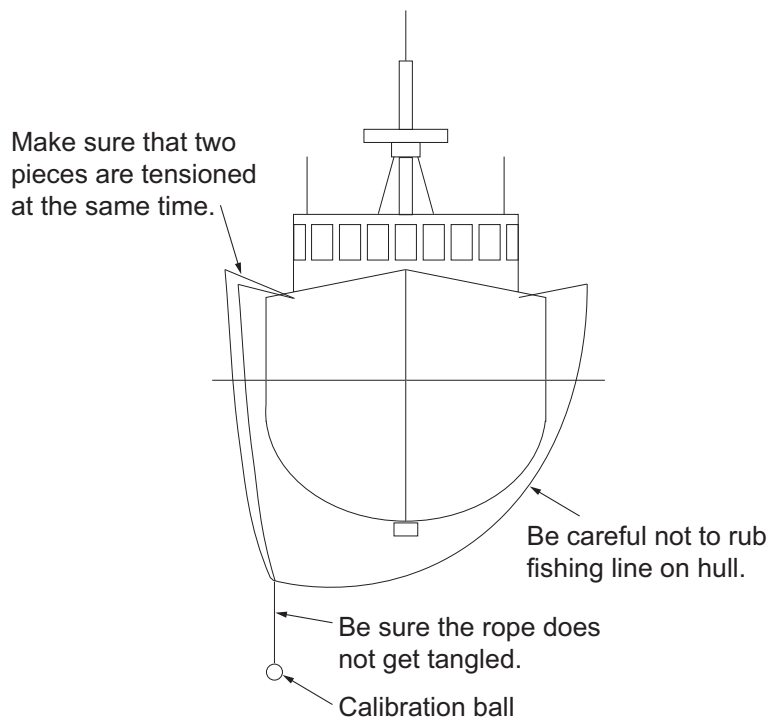
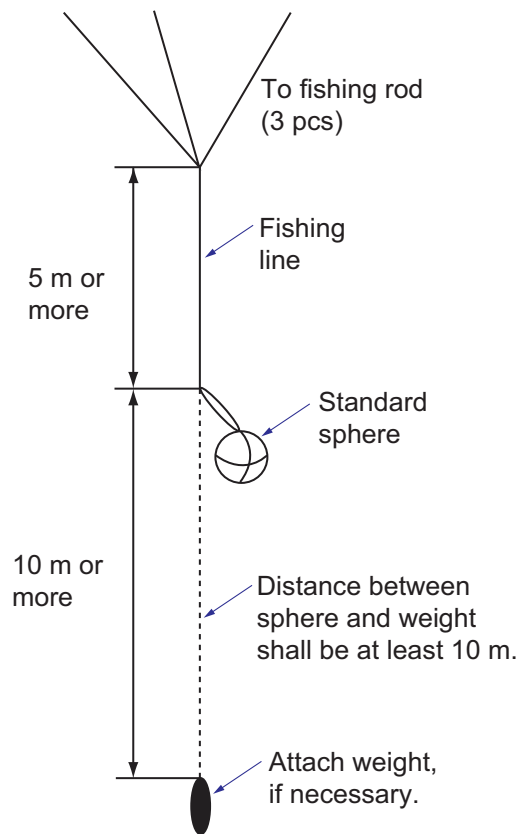

8. The installation of the standard sphere is correct when the three fishing lines are stretched to an equal length and have even tension. The distance from the hull (transducer) to the standard sphere shall be 15-20 m where the water depth allows.

Note: The farther the distance from the transducer to the calibration, the easier it will be to do the calibration. However, if the distance is too great, the standard sphere may land on the seabed. Therefore, ideally, the sphere should be at least 5-10 m from the seabed.

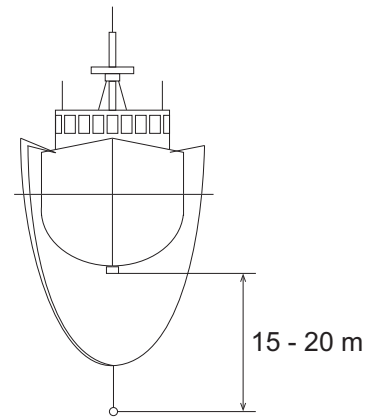



5.4 Calibration

5.4.1 Calibration procedure

Note 1: The calibration cannot be performed when auto range and/or auto shift is active. Set "Auto" in the "Range" menu to "Off".

Note 2: Calibration can also be performed using recorded echo data.

1. Use the split-beam display or the split beam/zoom display.
2. On the InstantAccess bar™, click the Sounder icon () then the Calibration Range icon (). The color of the Calibration Range icon changes to green, and the calibration range appears on the split-beam display.
3. Adjust the range and gain to show the echo from the standard sphere on the screen.

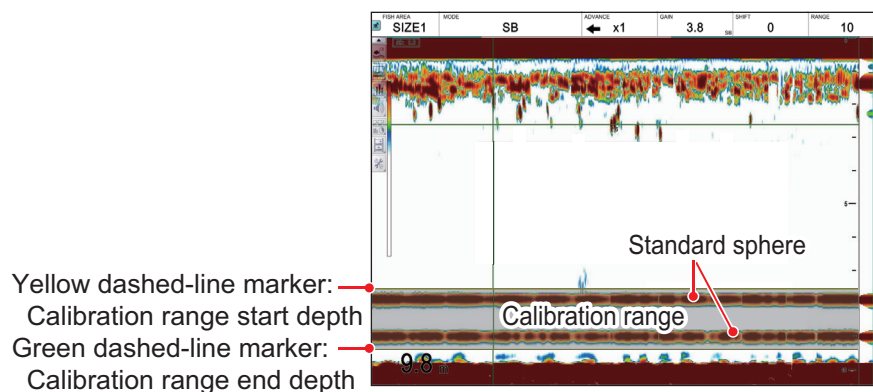



Display example: Two standard spheres used

4. Adjust the calibration range marker so that only the echo from the standard sphere is displayed within the calibration range. The calibration value is calculated from the difference between the TS value of the standard sphere detected within this range and the theoretical value. The calibration range can be adjusted in the following ways.
 - To change the calibration start depth, drag and drop the calibration start depth marker up and down.
 - To change the calibration end depth, drag and drop the calibration end depth marker up or down.
 - To move the calibration range up and down, drag and drop the calibration range within the calibration start depth and calibration end depth.

5. CALIBRATION

Note: For ease of calibration, use the fish length graph and the target position graph (vertical / horizontal) together to check the calibration condition. Set the measurement range on the echo from the standard sphere using the "specific area" measurement mode of the fish length graph.

5. Click the [Advanced Settings] icon () on the InstantAccess bar™, then click the [Advanced Settings] icon () to show the [Advanced Settings] window.
6. Click [Calibration Setting] to show the [Calibration Setting] window.

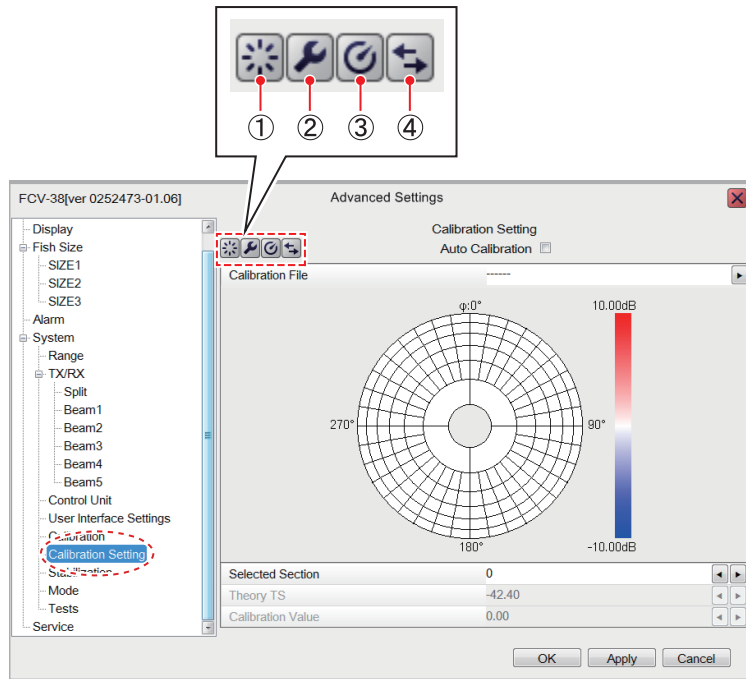

No.	Function
1	[Reset] button. Restores the [Calibration] window's default settings.
2	[Setting] button. Opens the [Calibration Setting] window.
3	[Measure] button. Starts measurement of the calibration value.
4	[Display Switch] button. Switches between the calibration display and the directivity display. See page 5-14.

7. Click the [Settings] icon () to show the [Calibration Setting] window.

Use this button to switch to the [Progress Details] window.

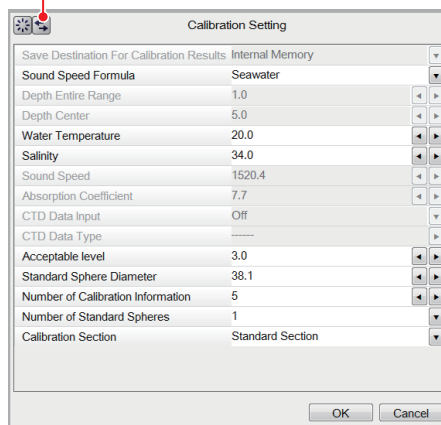

8. Set the items in the window, referring to the descriptions in the table below.

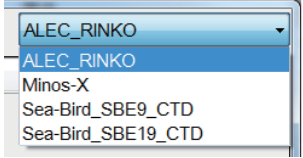
Item	Option
[Save Destination For Calibration Results]	Selects where to store calibration results (Internal Memory, External Memory, Internal Memory/External Memory). If no external memory is connected, that option is greyed out and the results are saved to the internal memory. The option Internal Memory/External Memory saves the results to both the internal and external memory.
[Sound Speed Formula]	Selects the formula to use for calculation of speed of sound (Seawater, Freshwater, Off).
[Depth Entire Range]	Sets the starting and end depth for the calibration. The setting range is 0.2 to 50.0(m). This setting is linked to the on-screen calibration range.
[Depth Center]	Sets the center of [Depth Entire Range] (Setting range: 1.0 to 5000.0(m)). This setting is linked to the on-screen calibration range.
[Water Temperature]	Available when [CTD Data Input] (see below) is set to [Off]. Set the water temperature value used for sound speed calculation (Setting range: -5.0 to 45.0(°C). When [CTD Data Input] is set to [On], the water temperature corresponding to the depth is automatically input if the water temperature value has been imported from the CTD data.
[Salinity]	Available when [CTD Data Input] (see below) is set to [Off]. Set the salinity value used for sound velocity calculation (Setting range: 0.0 to 100.0(psu)). When [CTD Data Input] is set to [On], the salinity corresponding to the depth is automatically input if the water temperature value has been imported from the CTD data.
[Sound Speed]	Available when [Sound Speed Formula] (see above) is set to [Off]. Set the sound velocity value (Setting range: 200.0 to 2000.0 m / s). If [Sound Speed Formula] is selected to other than [Off], calculation is performed from [Water Temperature], [Salinity], and [Depth Center], and the results displayed.
[Absorption Coefficient]	Calculated from [Water Temperature], [Salinity], and [Depth Center], and the results displayed.
[CTD Data Input]	Available when the following folders exist on the external storage medium. Drive name: \FURUNO\FCV38\data\CTDdata Set to [On] to use the CTD data file for sound velocity calculation".
[CTD Data Type]	<p>Available when [CTD Data Input] is set to [On]. To specify the CTD data file to use for sound velocity calculation, follow the steps below.</p> <ol style="list-style-type: none"> 1) Click the  button to show the [CTD File Select] window. 2) Use the drop-down list to select the format to use. The items shown in the list are the product names of other manufacturers. 3) Select the speed calculation to use, then click the [OK] button. The [CTD File Select] window is erased and the file information is imported. If there is something wrong with the file, the message "Cannot read the file correctly. Check the file and contents." appears. Check the contents of the file. 
[Acceptable Level]	Sets the allowable level (threshold) of the error between the acquired measured value and the theoretical value (Setting range: 0.0 to 10.0(dB)).

5. CALIBRATION

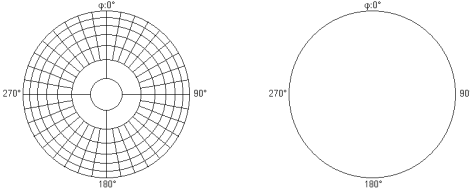
Item	Option
[Standard Sphere Diameter]	Sets the diameter of the standard sphere (Setting range: 0.1 to 100.0 (mm)).
[Number of Calibration Information]	Sets the measurement value acquisition count (threshold). (Setting range: 1 to 10 (ping)).
[Number of Standard Spheres]	<p>The number of echoes recognized as a single unit is taken as actual measurement value information for calibration.(1 or 2).</p> <ul style="list-style-type: none"> • When set to [1]: There are two detection results within the calibration range. Use the results from the shallower calculation. • When set to [2]: There are two detection results within the calibration range. determine the calibration value from each result. If only one result is available, calibrate with that data.
[Calibration Section]	<p>Selects the calibration section.</p> <ul style="list-style-type: none"> • [Standard Section]: Calibration is performed in each section. • [One Section]: Calibration is performed over the entire area. <div style="text-align: center;">  <p style="display: flex; justify-content: space-around; width: 100%;"> Standard Section One Section </p> </div>

9. Click the [OK] button to save settings, or click the [Cancel] button to discard changes.
 The [Calibration Setting] window closes after the [OK] button is clicked.
 At this point, the settings are not yet reflected to the [Calibration Setting] window.
10. Click the [Apply] button on the [Calibration Setting] window.
 The items set at step 8 are now reflected to the [Calibration Setting] window.
11. Select automatic or manual calibration, referring to the descriptions below.
 - **Manual calibration:** Manually send and receive and measure with the standard sphere to obtain the calibration value of the corresponding section. However, you need to move the standard sphere manually during calibration.
 - **Automatic calibration:** Automatically send and receive and measure with standard sphere to get the calibration values, in the order of the calibration section number (no need to move the standard sphere).

For automatic calibration, put a checkmark in the checkbox for [Auto Calibration] on the [Calibration Setting] window.

12. To start the calibration, click the [Measure] button () on the [Calibration Setting] window.
 The [Calibration Setting] window is closed, then the [Progress] window appears.
 The calibration proceeds as shown in the figure below.

[Setting] button
 [Display Switch] button

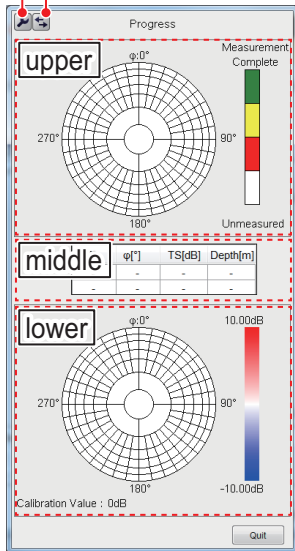

Start of calibration

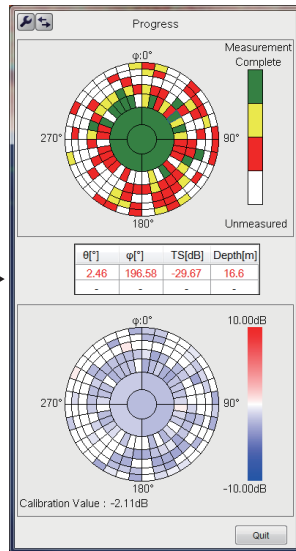

Acquiring standard sphere detection information

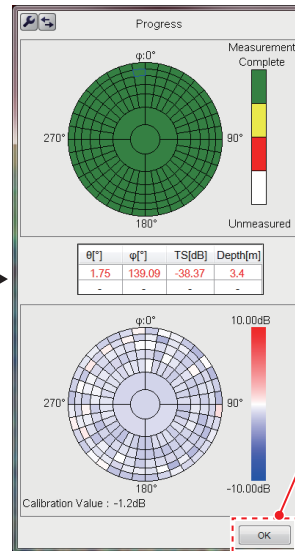

Acquiring standard sphere detection information in all sections

When all sections turn green in the top display, the status of button changes from [Quit] to [OK].

Window	Description
Upper	<p>The sections for which measurement values need to be acquired are displayed. The color of each section indicates the progress during the measurement.</p> <ul style="list-style-type: none"> White: Measured value not acquired Red: Measured value obtained only once Yellow: [Number of Calibration Information] (see page 5-10) × Acquisition of measured value more than 1/2 times (decimal point rounded up) Green: Measurement value acquisition completed (calibration information acquisition completed) <p>For example, if [Number of Calibration Information] is set to "5", the measurement value will be yellow if it can be acquired three or more times, and green if it can be acquired five times.</p> <p>The section detected in the latest transmission is circumscribed with a blue frame.</p>
Middle	<p>The information detected by the latest transmission is displayed (maximum of two).</p> <ul style="list-style-type: none"> Measured θ, ϕ, TS, and Depth are shown. <ul style="list-style-type: none"> θ: Shows how many standard spheres are outside from the center (unit: $^{\circ}$). ϕ: Indicates how many times the standard sphere rotates from the bow (unit: $^{\circ}$). TS: Measured value of standard sphere (unit: dB) Depth: Depth of standard sphere (unit: m) "-" appears where no detection information was found. If [Number of Standard Spheres] is set to "1", the 2nd column shows "-" always. When the detection information is out of the acceptable level, the information appears in red.

5. CALIBRATION

Window	Description
Lower	<p>The color of each plot represents the difference between the theoretical value and the measured value.</p> <ul style="list-style-type: none"> • White→Blue: The difference between the theoretical value and the measured value is a negative value. As the difference increases, the color changes from white to blue. • White→Red: The difference between the theoretical value and the measured value is a positive value. As the difference increases, the color changes from white to red. <p>The bottom left shows the calibration values for the selected section. If not selected, the calibration value of the center section is displayed.</p>

13. After the measurement is completed, click the [OK] button on the [Progress] window.

Control is returned to the [Calibration Setting] window, where the measured calibration value appears. The calibration results file is saved to the location selected with [Save Destination For Calibration Results] (on the [Calibration Setting] window).

Note: To quit the measurement, click the [Stop] button. The confirmation message "Use calibration data from immediately prior to quitting?" appears. Click the [Yes] button to quit, or the [No] button to continue the measurement. If you elected to quit, the calibration file is saved to the specified location. However, regardless of the selection, the calibration information immediately before the measurement was stopped is deleted when the power is turned off.

The screenshot shows the 'Advanced Settings' window for 'FCV-38[ver 0252473-xx.xx]'. The 'Calibration Setting' tab is active, with 'Auto Calibration' checked. A circular section diagram is displayed, showing a color scale from -10.00dB (blue) to 10.00dB (red). A table at the bottom shows the calibration values for the selected section (0):

Selected Section	0
Theory TS	-42.40
Calibration Value	-1.25

Red arrows point to the table and the color scale, with labels: "Calibration values are maintained for each section." and "See the table below."

Window	Description
[Selected Section]	Click the numerical value change button (◀ ▶) to select the section to display, edit its calibration value (setting range: 0 to 184). You can also click the applicable section on the section diagram.
[Theory TS]	The theoretical value calculated by the settings in the [Calibration Settings] window (see page 5-8) is displayed. You can also manually change the TS theoretical value by clicking the numerical value change button (◀ ▶)(Setting range: -80.00 to -20.00(dB)).
[Calibration Value]	The calibration value of the section set in [Selected Section] above is displayed. You can also manually change the calibration value by clicking the numerical value change button (◀ ▶) (Setting range: -10.00 to 10.00(dB)).

14. Click the [OK] (or [Apply]) button on the [Calibration Setting] window to apply the measured calibration values (or manually input [Theory TS] and [Calibration Value] to the unit.

Note: If the [Stop] button is clicked at step 13, the message "Restarting calibration. Start from the last quit point?" appears the next time you click the [Measure] button on the [Calibration Setting] window. Click the [Yes] or [No] button.

5.4.2 Operations available during the measurement

The following operations are available during the measurement.

- Switch between the calibration display and the directivity display.
- Switch to the [Progress Details] window.
- Set the calibration extraction area.

Switch between calibration display and directivity display

You can switch between the calibration display and the directivity display (2D, 1D).

Click the [Display Switch] button (↔) on the [Progress] window. Each click changes the display in the sequence shown below.

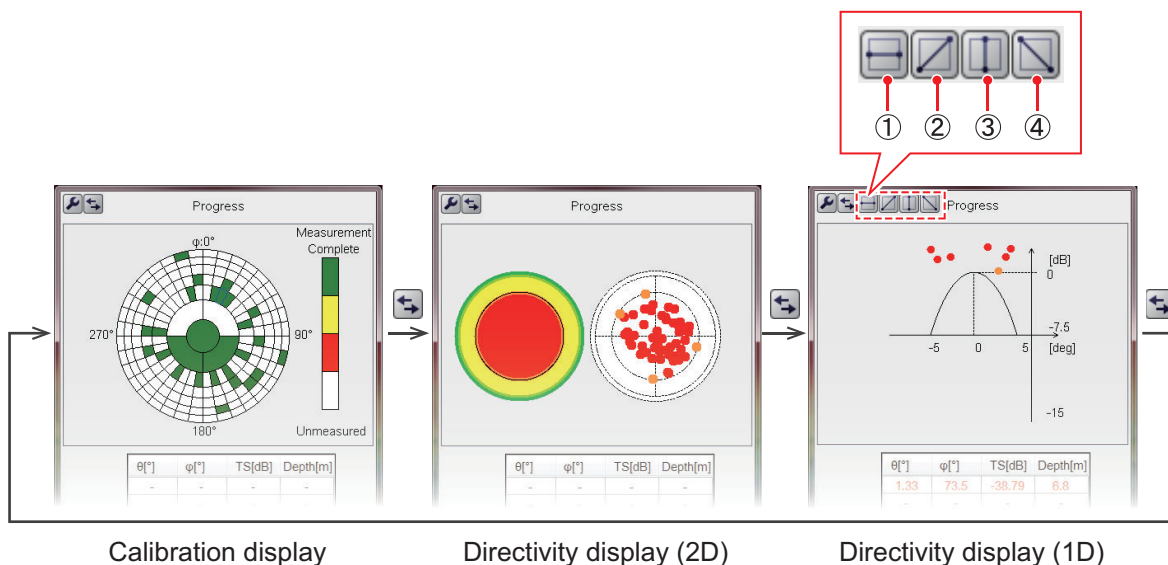

- **2D display:** Information obtained during calibration is color-coded by section and plotted with circles.
- **1D display:** The horizontal axis directional angle (deg) and directional characteristic value (dB) shown for a specific section*.
 - * The direction can be switched with the buttons on the above window ((1) 90° to 270°, (2) 135° to 315°, (3) 0° to 180°, (4) 45° to 225°).

Switching to the Progress Details window

Follow the procedure shown below to switch to the [Progress Details] window.

1. Click the [Wrench] button (🔧) on the [Progress] window to show the [Calibration Setting] window.
2. Click the [Display Switch] button (↔) on the [Calibration Setting] window to switch to the [Progress Details] window. The [Progress Details] window shows the information detected (a maximum of 10800 points) during measurement is displayed in the "Progress Details" window (up to 10,800 points). For the meaning of θ , ϕ , TS, and Depth, see page 5-11.

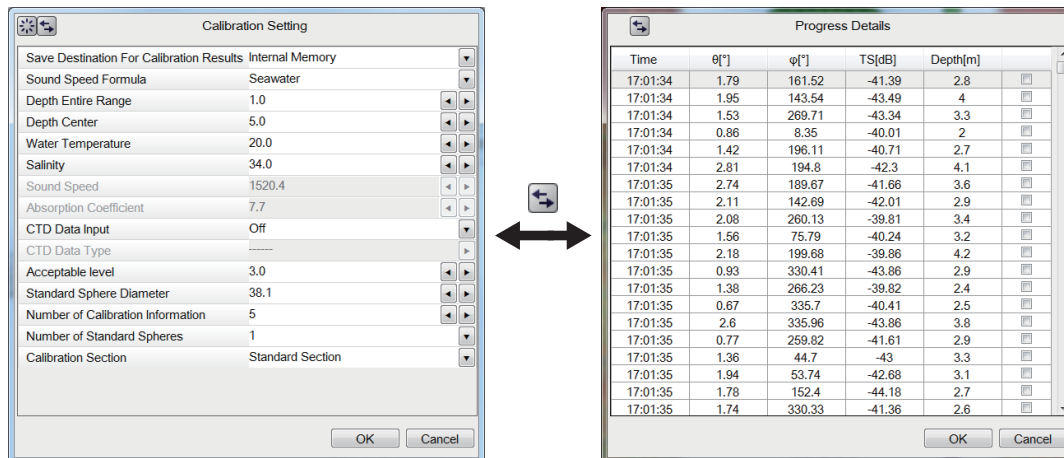

Click the item name ([Time], [θ], [ϕ], [TS], [Depth]) at the top of the list in the [Progress Details] window to sort the list in ascending order or descending order. Clicking on a number in the list turns the corresponding section of the [Progress] window (upper) blue.

3. To remove detection information from the calculation of the calibration value, check the check box in the rightmost column of the [Progress Details] window. Checked items appear in red.
4. Click the OK button to close the [Progress Details] window.

Calibration extraction area

Unnecessary echoes may appear in the calibration area, which can prevent accurate calibration. If this occurs, set a "calibration extraction area" to extract unnecessary echoes from the measurement results.

Note: Echoes removed from the extraction area in the measurement results are reflected in the [Progress] window, [Progress Details] window, calibration measurement values, and all results in the 2D directivity display.

1. During measurement, set a calibration extraction area (a maximum of 10 can be set). To set a calibration extraction area, press the left button at any position, drag the cursor, and release the left button at the desired position. The frame of the calibration extraction area is displayed in red. Information removed from the calibration extraction area is displayed in red in the [Progress Details] window. In addition, the display color of the calibration value of the corresponding section in the [Progress] window is redrawn with the recalculated result.
2. To delete a calibration extraction area, move the cursor inside the area, then right-click.

5.4.3 Operations available after completion of the measurement

The following operations are available after the completion of the measurement.

- Edit the calibration results.
- Extract measured area using the directivity display (1D).

How to edit calibration results

Follow the procedure below to edit calibration results.

1. Click the (▶) button for [Calibration File] on the [Calibration Setting] window to show the [Calibration File Select] window.
If no external memory device is connected, go to step 3. Otherwise, go to step 2.
2. From the drop down list below the title bar, select the location ([Internal Memory] or [External Memory]) of the calibration file.
A list of files stored in the selected memory appears.

File location drop-down list

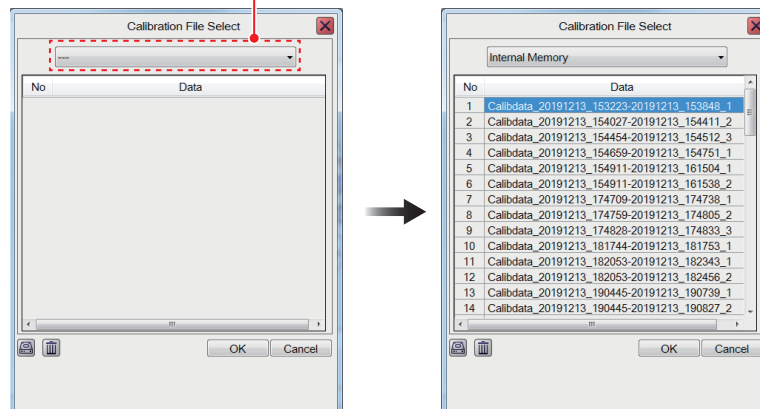

The left side of the above figure appears only when an external recording device is connected.

3. Select the calibration file to use.
Note 1: You can copy calibration files to the internal memory and external memory. To copy a file, select the file, then click the Copy button (📄) at the bottom-left corner of the window.
Note 2: To delete a calibration file, select the file, then click the Delete button (🗑️) at the bottom-left corner of the window. The message "The selected file will be deleted. Are you sure?" appears. Click the [OK] button to delete the file.
4. Click the [OK] button. The file selected at step 3 is loaded, and reflected to the [Calibration Setting] window. If file error is found, the message "Cannot read the file correctly. Check the file and contents." appears.
5. Change the values of [Theoretical TS] and [Calibration Value] manually.
The calibration value is changed with adjustment of the theoretical TS.
6. To apply edited calibration values to this unit, click the [OK] button (or [Apply] button) the [Calibration Setting] window. The message "Re-calculate the calibration and theoretical values?" appears.
7. Click the [Yes] button. The message "Calibration values changed. Overwrite currently saved data?" appears.

5. CALIBRATION

- Click the [Yes] button to overwrite currently saved data (or the [No] button to escape). The message "Calibration values changed. Save data as a new file?" appears.
- Click the [Yes] button to save the data as a new file (or the [No] button to escape).

How to extract a measured points using the directivity display (1D)

Using the directivity display, measured points can be extracted to adjust the calibration value.

- Do steps 1 - 4 in section 5.4.3 to select the calibration file from which you want to extract measured points.
- On the [Calibration Setting] menu, click the [Display Switch] button (🔍) a few times to show the 1D directivity display.
- Use the selection frame to select the measurement points to extract. To specify a range, press the left button at any position, drag the cursor, and release the left button at the desired position. The selection frame is displayed in red.

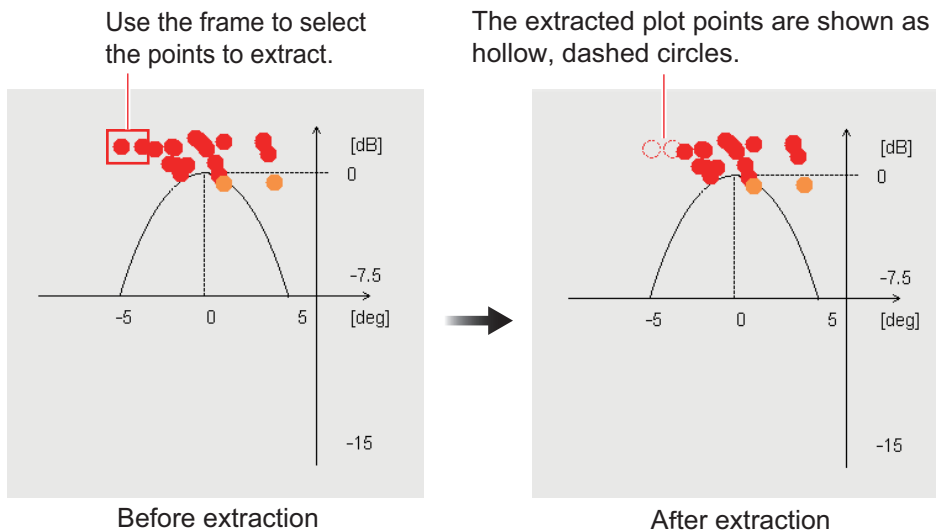

Note: Echoes extracted on the 1D directivity display are reflected in the [Progress] window, [Progress Details] window, calibration measurement values, and all results in the 2D directivity display.

- To restore extracted points, reselect the points. The hollow, dashed-line circles change to filled, solid-line circles.

6. MAINTENANCE AND TROUBLESHOOTING

This chapter contains maintenance and troubleshooting procedures for the operator. If you suspect trouble, do not attempt to check inside any unit. Refer any repair work to a suitably qualified technician.

WARNING

ELECTRICAL SHOCK HAZARD
Do not open the equipment.

This equipment uses high voltage that can cause electrical shock. Only qualified persons can work inside the equipment.

NOTICE

Do not apply paint, anti-corrosive sealant or contact spray to plastic parts or equipment coating.

Those items contain products that can damage plastic parts and equipment coating.

6.1 Maintenance

Regular maintenance is essential for good performance. Check the points shown in the table below to keep the equipment in good working order.

Check Point	Action	Remedy, remarks
Cables	Check that all cabling is firmly connected and is not damaged.	<ul style="list-style-type: none"> • Connect the cable if it has loosened. • Replace damaged cables.
Connectors on units	Check for tight connection.	<ul style="list-style-type: none"> • Reconnect as necessary.
Ground on units	Check for tight connection and rust.	<ul style="list-style-type: none"> • Fasten if loosened. • Remove rust if present.
Dust	Remove the dust or dirt from the units with a soft, dry cloth.	<ul style="list-style-type: none"> • Do not use chemical-based cleaners to clean the equipment because they can remove paint and markings.
Transducer	Marine life on the transducer face will result in a gradual decrease in sensitivity. Check the transducer face for cleanliness each time the boat is dry-docked.	<ul style="list-style-type: none"> • Carefully remove any marine life to prevent the damage to the transducer. • Do not paint (including hull paint) the transducer. • Do not use chemical-based cleaners to clean the transducer.

6.2 Trackball Maintenance

If the cursor moves abnormally, clean the trackball and inside the trackball housing (including the lens) as shown below:

1. Turn the retaining ring on the trackball module in the direction of the arrows (see figure below) to unlock it, then remove the retaining ring.

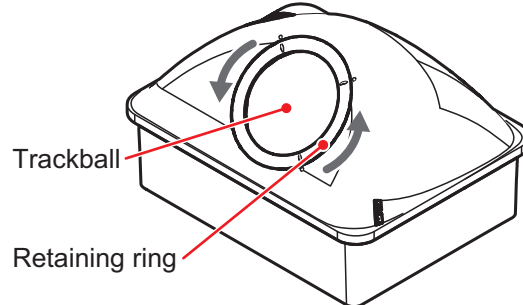

2. Put cellophane tape on the trackball then pull on the tape to remove the trackball from the trackball housing.
Place the trackball and the retaining ring on a clean, soft cloth laid on a flat surface.
3. Clean the ball with a damp, soft cloth, then use a dry, lint-free cloth to carefully wipe the ball dry.
4. Use a swab, moistened with water, to carefully clean the inside of the retaining ring, the inside of the trackball housing, the supports and the lens. Change the swab regularly so that dirt and dust build-up is easily removed. Use a dry swab to wipe away moisture.

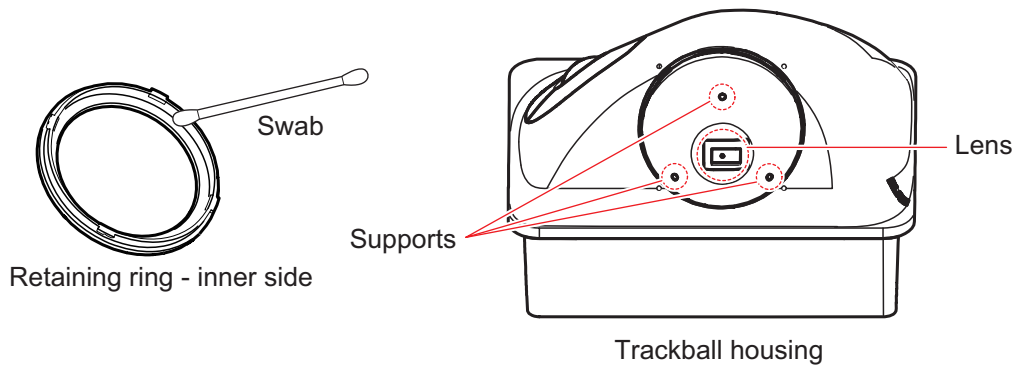

5. Re-set the ball and retaining ring. Be sure the retaining ring is not inserted reversely.

6.3 Fuse Replacement

The Processor Unit and Transceiver Unit are protected from overcurrent and equipment fault by their fuse. If a unit cannot be powered, its fuse may have blown. If a fuse has blown, find the reason before replacing the fuse. If a fuse blows after replacement, contact your dealer for advice.

 WARNING
 Use the proper fuse. Use of a wrong fuse can cause fire or damage the equipment.

Fuse location	Fuse type	Part no.	Remarks
Processor Unit (power cable)	FGBO-A 125V 15A PBF	000-155-827-10	12 VDC
	FGBO-A 125V 7A PBF	000-164-965-10	24 VDC
Transceiver Unit (behind power switch cover on underside of unit)	FGBO-A 125V 5A PBF	000-155-840-10	

6.4 Battery Replacement

The mother board in the Processor Unit contains a backup battery. When the battery voltage is low, the time shown on the internal clock is incorrect. (However, if the time and date are fed from an external source, with the ZDA sentence, the correct time is shown.

 CAUTION
Use only the specified battery. When replacing the battery, make sure the polarity is correct. Incorrect replacement of the battery can cause the battery to explode.

Name	Type	Code no.	Estimated life
Battery Kit	BATTERY KIT-FJ	000-196-791-10	10 years

Note 1: When the battery voltage is 2.6 V or lower, the error window (error code: P01) appears at the center of the screen. Have a FURUNO representative replace the battery at your earliest convenience.

Note 2: Used batteries should be disposed of according to the applicable local standards and laws. Cover the battery terminals with tape to prevent heat generation, fire, etc. by short circuit.

6.5 Troubleshooting

The table below provides basic troubleshooting procedures which the user may follow to restore normal operation. If you cannot restore normal operation, do not check inside the equipment. Contact your dealer to check the equipment.

Problem	Reason, remedy
Cannot turn on power.	<ul style="list-style-type: none"> • The power cable is disconnected or damaged. Check the cable, and reconnect or replace it as necessary. • The cable connected to the Trackball Control Unit or the Transceiver Unit is disconnected or damaged. Check the cable, and reconnect or replace it as necessary. • Check ship's mains. • Check the fuse on the Processor Unit and Transceiver Unit. If a fuse has blown, find the cause then replace it.
There is no response when the Trackball Control Unit is operated.	<ul style="list-style-type: none"> • The cable connected to the Trackball Control Unit is disconnected or damaged. Check the cable, and reconnect or replace it as necessary. • Reboot the system. If you do not get a response, the Trackball Control Unit may be damaged. Contact your dealer for instructions.
USB flash memory is inserted in USB port on the Trackball Control Unit, however screenshots cannot be saved.	<ul style="list-style-type: none"> • The USB cable between the Trackball Control Unit and the Processor Unit is disconnected or damaged. Check the cable, and reconnect or replace it as necessary.
Characters and markers appear but no echoes.	<ul style="list-style-type: none"> • Picture advance is stopped. Referring to section 1.6, set [Pic. Advance] to other than [Stop]. • Check if the scrollbar mode (see section 1.25) is active. • The transducer cable is disconnected or damaged. Check the cable, and reconnect or replace it as necessary.
Echo appears but no zero line.	<ul style="list-style-type: none"> • The displayed area is shifted. Referring to section 1.8, set the shift to [0]. • The zero line rejection is turned on. Referring to section 4.7.5, turn it off. • The setting of the draft line is improper. Referring to section 4.7.5, set the draft correctly.
Sensitivity is low.	<ul style="list-style-type: none"> • Gain setting is too low. Referring to section 1.7, increase the gain. • Marine life is adhering to transducer face. Clean the transducer face. • Vessel is in heavily sedimented water. • Bottom is too soft to return an echo.
Extreme interference or noise.	<ul style="list-style-type: none"> • Transducer may be too close to the engine. Stop the engine and check for noise on the screen. If noise is present contact a FURUNO agent or dealer for advice. • Ground wire has loosened or is damaged. Check the wire, and reconnect or replace it as necessary. • Same-frequency echo sounder is operating nearby.
No depth indication.	<ul style="list-style-type: none"> • Bottom is off the screen. Referring to section 1.9, adjust the range setting. • Depth indication is hidden. Referring to section 1.16, show the depth indication. • [Bottom Search] is set to [Off]. Referring to section 4.7.2, change the setting to [On].
Speed and/or water temperature readout is unrealistic or not shown.	<ul style="list-style-type: none"> • The sensor cable is disconnected or damaged. Check the cable, and reconnect or replace it as necessary. • The sensor is malfunctioning. Check the sensor.

Problem	Reason, remedy
Position readout is unrealistic or not shown.	<ul style="list-style-type: none"> The cable connected to the navigation equipment is disconnected or damaged. Check the cable, and reconnect or replace it as necessary. The navigation equipment is malfunctioning. Check the navigation equipment.
On-screen display is not showing correctly after replacing the monitor.	A new monitor must be set up from the [Service] menu. Contact your local dealer.

6.6 Error Messages and Icons

When an error occurs, the system does the following:

- Releases an aural alert,
- displays the error window at the screen enter, and
- displays the applicable error icon at the bottom-right corner on the screen.

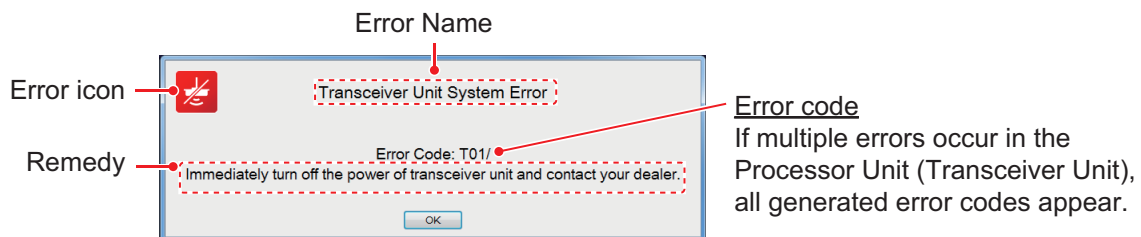

The error window shows the applicable error icon error name, error code and error remedy.



When an error occurs, click the [OK] button in the error window to silence the aural alarm. The error icon remains on the screen until the error is resolved. The error icon can be clicked to display error content, in the error window. If multiple errors occur simultaneously, the error having the highest priority is displayed. The table below shows the error icon, error name, error code, reason/remedy and priority order for each error type.

If the error window appears repeatedly, contact a FURUNO dealer to request service.



Error Icon	Error name	Error code	Reason, remedy	Priority Order
	Control Unit Communication Error	C01	Communication error between the Trackball Control Unit and the Processor Unit. Check the connection between the Trackball Control Unit and Processor Unit.	1
	External E/S Communication Error	E01	<ul style="list-style-type: none"> Communication error between the external fish finder and Processor Unit. Check that DFF3 is powered. Also, check the connection between the DFF3 and the Ethernet HUB (HUB-101) and the Ethernet Hub and the Transceiver Unit. For the DFF3, this error occurs if the FCV-38 is not powered within approximately 90 seconds after powering the DFF-3. Connection can take up to seven minutes. When the connection is complete, this error disappears. 	2

Error Icon	Error name	Error code	Reason, remedy	Priority Order
	Processor Unit System Error	P01	The voltage of the battery inside the Processor Unit is low. Turn the equipment off, then contact your local dealer to request replacement of the battery.	4
		P02	The fan in the Processor Unit is rotating too slowly. Turn the equipment off, then contact your local dealer to request replacement of the fan.	5
		P05	Multiple alike IP addresses found. Turn the equipment off, then contact your local dealer for advice. (IP address setup is in the [Service] menu.)	6
	Transceiver Unit System Error	T01	Communication error between the Transceiver Unit and Processor Unit. Turn the equipment off, then contact your local dealer for service.	3
		T03	The rotating speed of the FAN1 in the Transceiver Unit is abnormal. Turn the equipment off, then contact your local dealer for service.	7
		T04	The rotating speed of the FAN2 in the Transceiver Unit is abnormal. Turn the equipment off, then contact your local dealer for service.	8

6.7 Tests Menu

You can run a diagnostic test, or view detailed information about your equipment, from the [Tests] menu.

To access the [Tests] menu, do the following:

1. Click the [Advanced Settings] icon () from the InstantAccess bar™, then click the [Advanced Settings] icon () to show the [Advanced Settings] window.
2. Click [Tests] to show the [Tests] menu, on the right-hand side of the window.

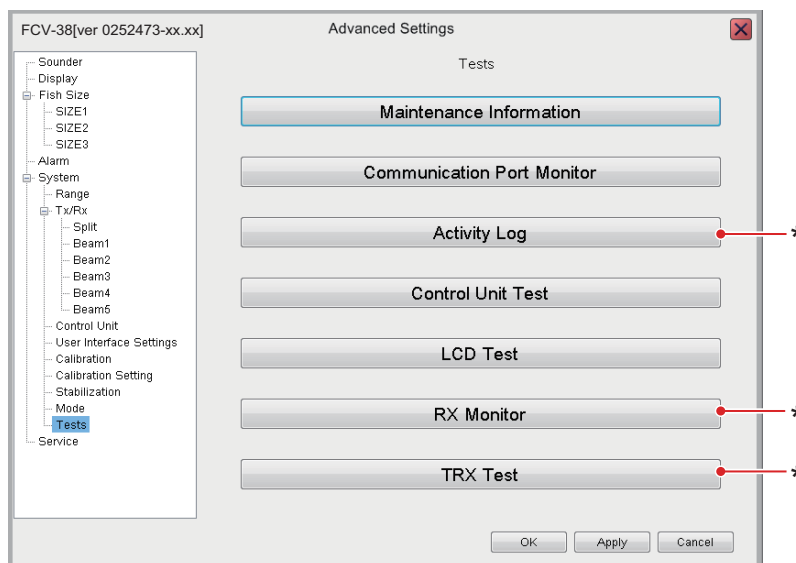

* These items are for maintenance/service purposes and are not accessed normally.

6. MAINTENANCE AND TROUBLESHOOTING

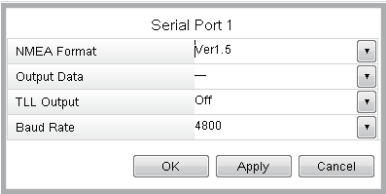
No.	Item name	Description
1	[Refresh] button	Select to update the display area.
2	Port tabs	Select a tab to show the corresponding port details in the display area. <ul style="list-style-type: none"> • [Serial Port 1] - [Serial Port 5]: Shows incoming NMEA data for ports 1 - 5. • [Network]: Shows incoming NETWORK port data from the processor unit.
3	Display area	Shows the incoming data details for the selected port.
4	[Settings] button	Access the output settings window for the selected port. Note: This button is not available for the [Network] tab. <div style="text-align: center; margin: 10px 0;">  </div> <ul style="list-style-type: none"> • [NMEA Format]: Set the NMEA format to use for data output. Available options are [Ver1.5], [Ver2.0], [Ver3.0]. Note: Whenever the NMEA format is changed, the settings of all other items in the window are returned to default. • [Output Data]: Where [TLL Output] is set to [FURUNO-TLL], select the information to output. More than one item can be selected, among the following: <ul style="list-style-type: none"> [Depth]: Output depth data. [Temperature]*1: Output water temperature data. [Hardness And Roughness]: Output bottom material data (hardness, roughness). [Fish Size]*2: Output fish size graph data. • [TLL Output]: Select which TLL data to output. The data will be output when a TLL line is inscribed. <ul style="list-style-type: none"> [Off]: No TLL data is output. [TLL]: Only latitude and longitude*1 are output. [FURUNO-TLL]: Latitude and longitude*1 and items selected at [Output Data] are output. (Requires connection to a FURUNO-TLL compatible device.) • [Baud Rate]: Set the data transfer speed. The available options are [600], [4800], [38400] (bps). Note: Set to [38400] when the [TLL Output] setting is [FURUNO-TLL]. The output interval is delayed with the setting [600] or [4800]. When the settings are changed, click the [Apply] button to apply new settings. *1: Requires applicable data. *2: Displayed when [Baud Rate] is set to 38400.

To close the [Communication Port Monitor], the [Close Window] icon (☒) at the top-right corner of the window.

6.7.3 How to test the Control Unit

You can test the buttons, scrollwheel and trackball of the Control Unit for proper operation at any time.

To activate the test, click [Control Unit Test] from the [Tests] menu.



No.	Function
1	Check the buttons, scrollwheel, and trackball for proper operation. <ul style="list-style-type: none"> • Button: Hold down a button. The button's on-screen location turns red if the button is normal. • Scrollwheel: Push and scroll the scrollwheel. The scrollwheel's on-screen location turns red if the scrollwheel is normal. • Trackball: Roll the trackball. The trackball's on-screen location turns red if the trackball is normal.
2	Turns the unit's back-light on or off.
3	Turns the unit's operation beeps on or off.
4	Shows the coordinates (X, Y) of the cursor. If the coordinate values change with trackball operation, the trackball is functioning normally.
5	Shows scrollwheel movement. If the value changes with scrollwheel operation, the scrollwheel is functioning normally.
6	Starts the Control Unit test. To quit the test, right click three times.

To close the [Control Unit Test], click the [Close Window] icon (✖) at the top-right corner of the window.

6.7.4 LCD test

The [LCD Test] tests if the LCD can display all available colors clearly. **Left-click** to change screens in the order shown below. To stop the test at anytime, **right-click**.

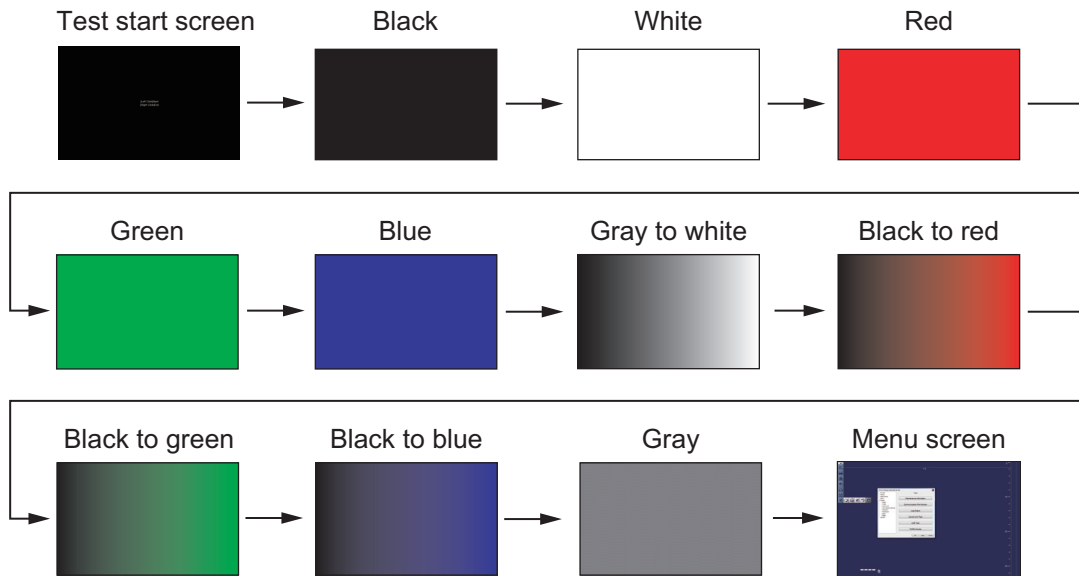

APPX. 1 MENU TREE

[Advanced Settings] menu



Default settings in bold italic.

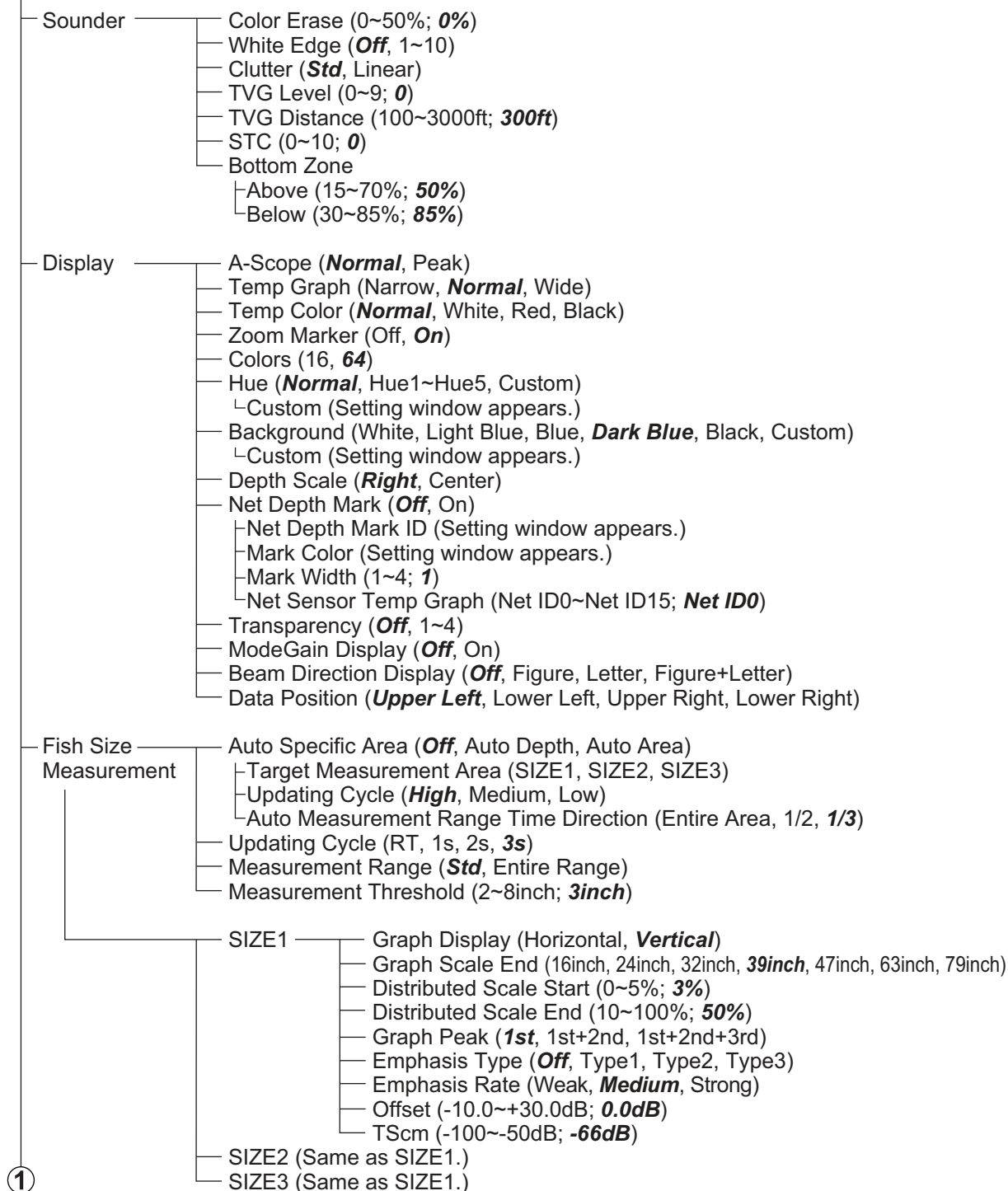

①

APPX. 1 MENU TREE

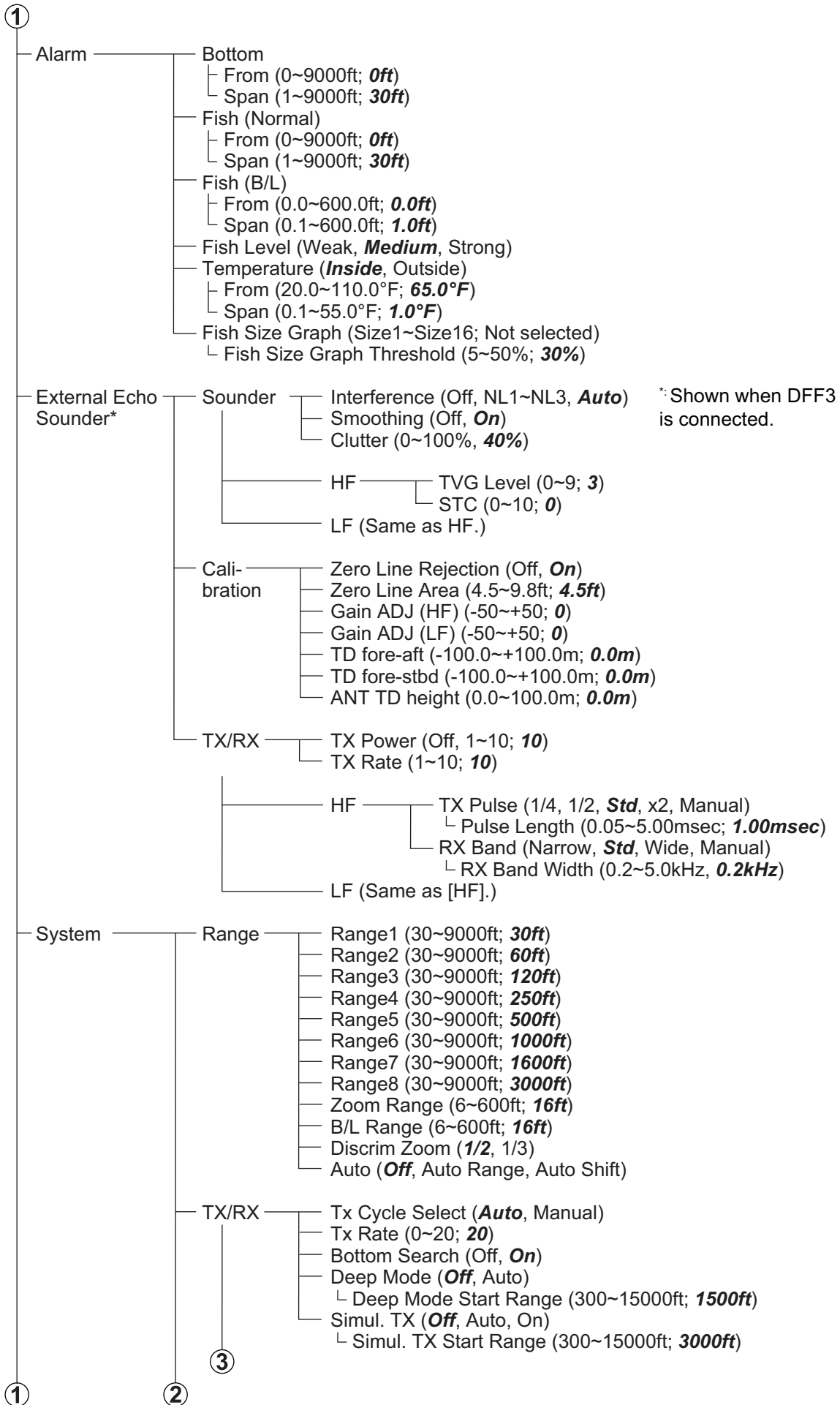

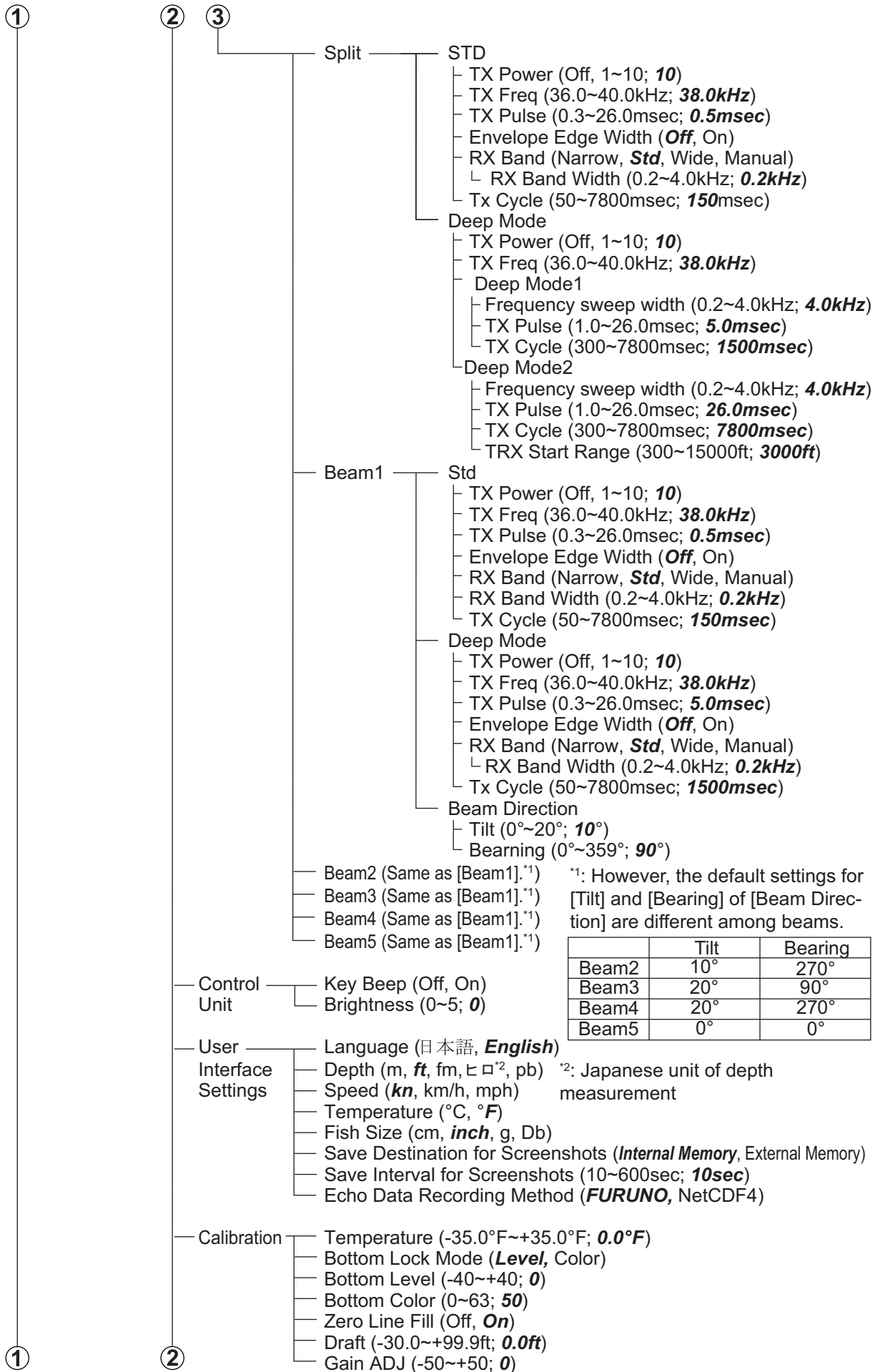

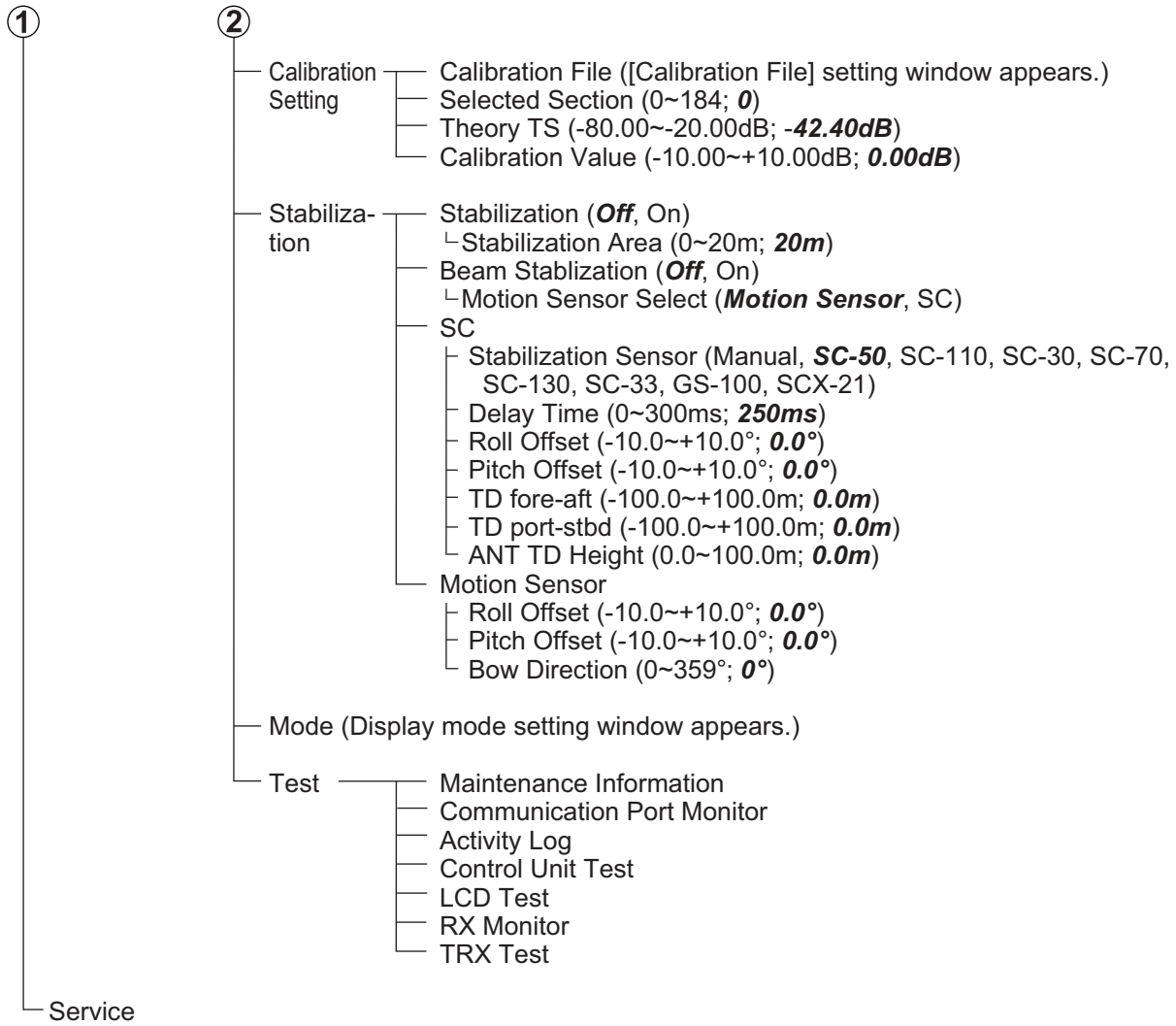

External Fish Finder Menu

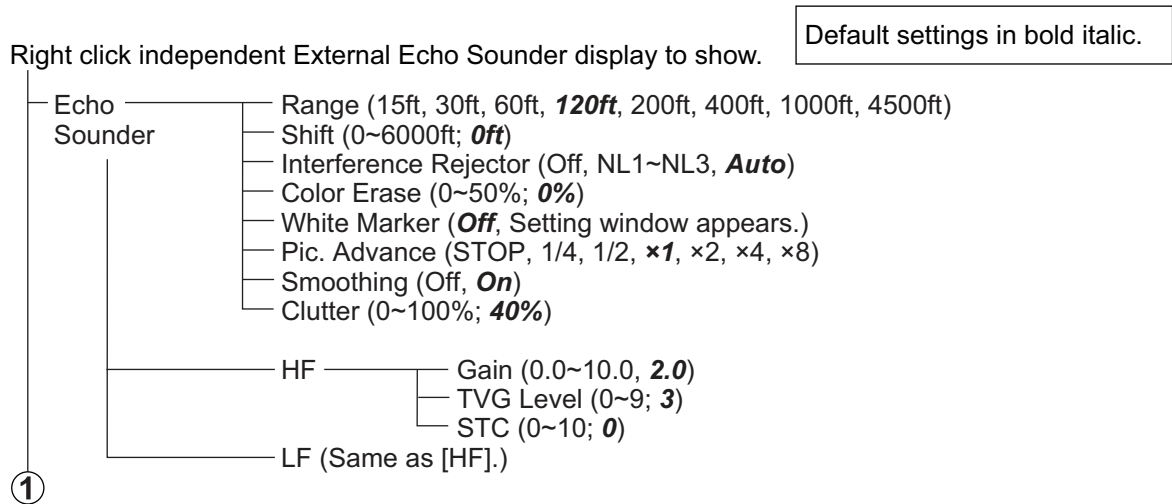

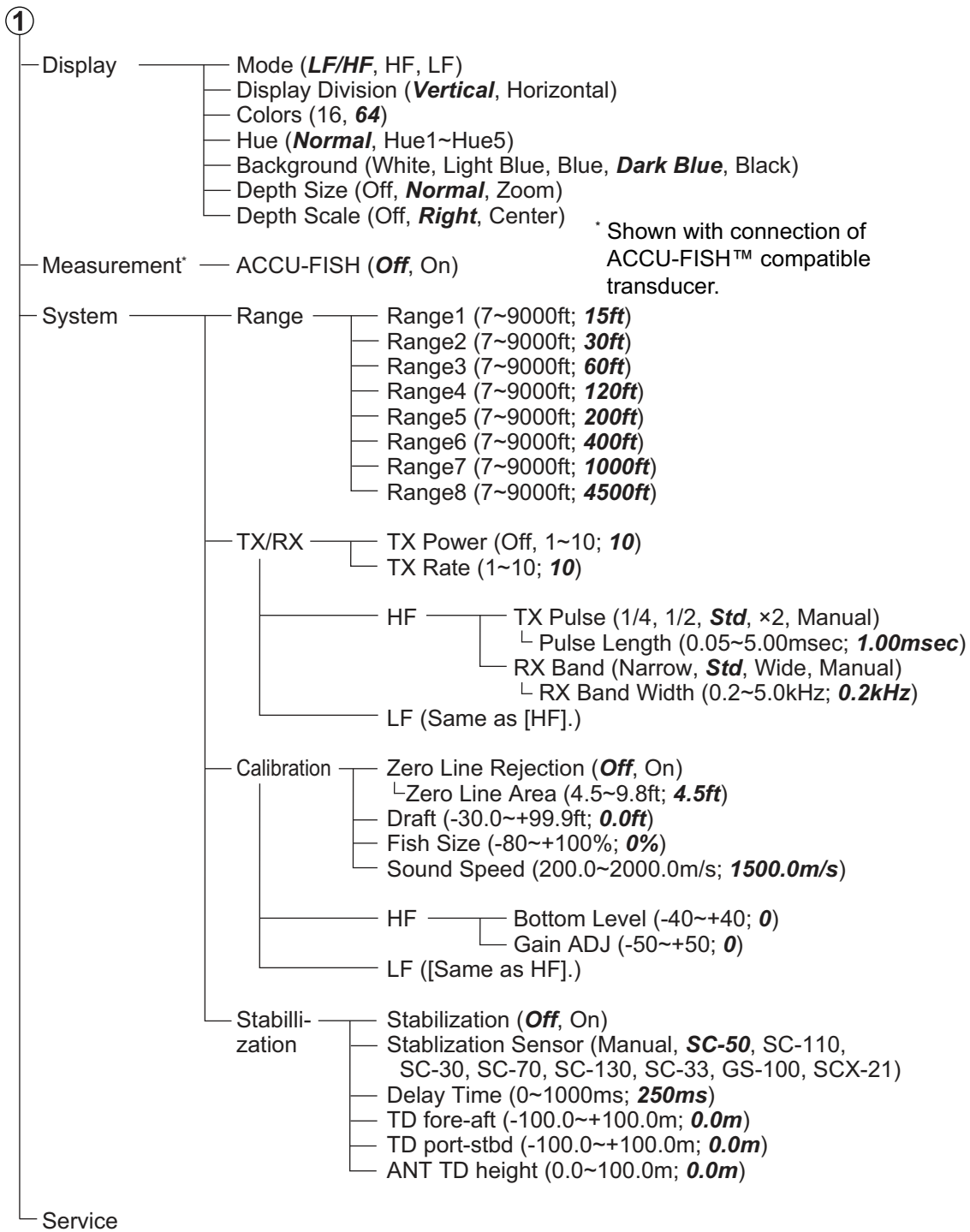

APPX. 2 SCREEN LAYOUTS

A-scope not shown

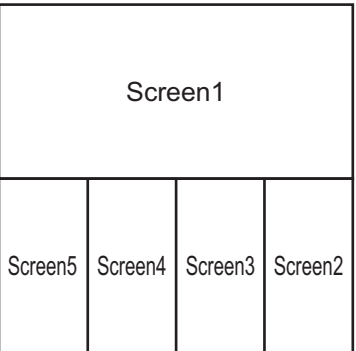
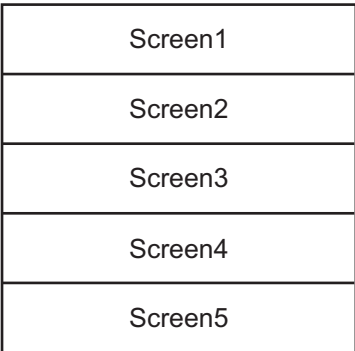
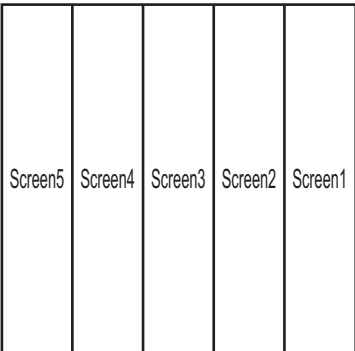
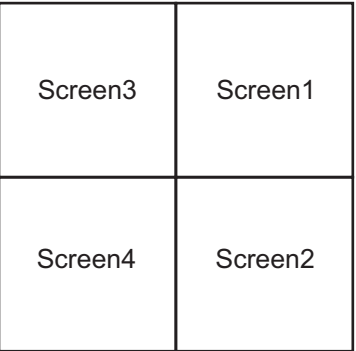
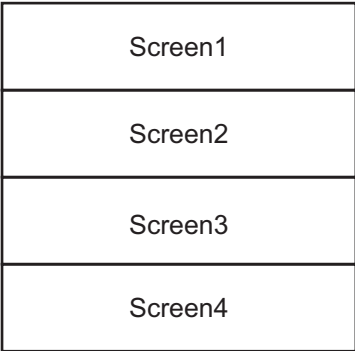
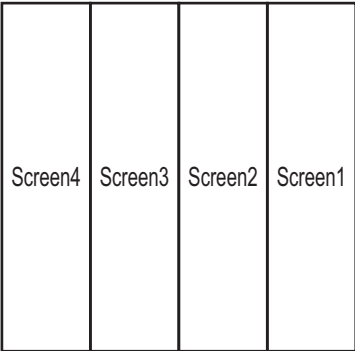
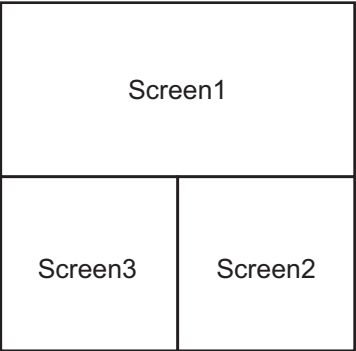
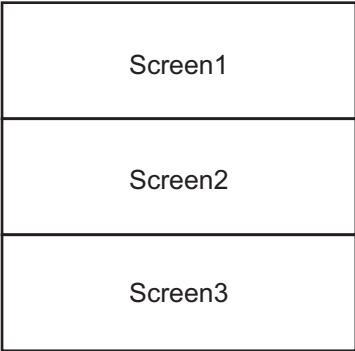
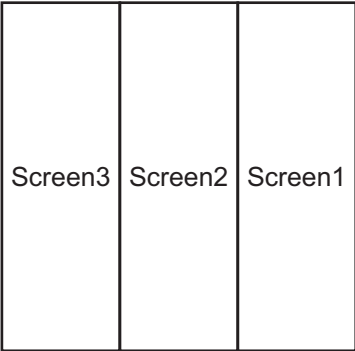
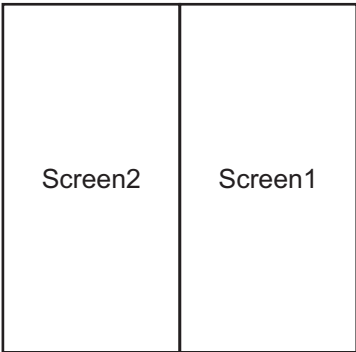
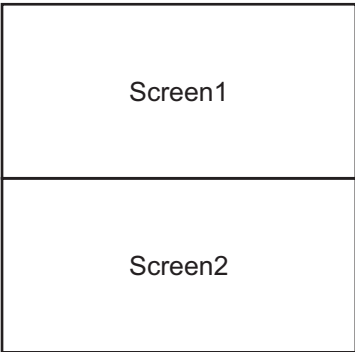
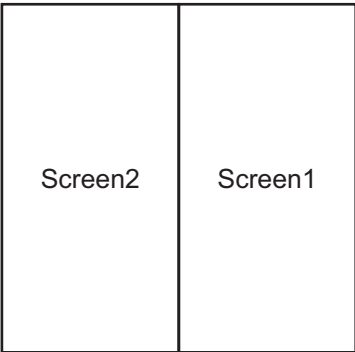

Vertical division

Horizontal division

Mixed division

A-scope shown

Screen1 A-Scope	
Screen1	Screen2

Screen1 A-Scope	Screen2 A-Scope
Screen1	Screen2

Screen1 A-Scope	
Screen1	Screen2

Screen1 A-Scope		
Screen1	Screen2	Screen3

Screen1 A-Scope	Screen2 A-Scope	Screen3 A-Scope
Screen1	Screen2	Screen3

Screen1 A-Scope	Screen1	
Screen2 A-Scope	Screen2	Screen3

Screen1 A-Scope			
Screen1	Screen2	Screen3	Screen4

Screen1 A-Scope	Screen2 A-Scope	Screen3 A-Scope	Screen4 A-Scope
Screen1	Screen2	Screen3	Screen4

Screen1 A-Scope	Screen1	Screen3
Screen2 A-Scope	Screen2	Screen4

Screen1 A-Scope				
Screen1	Screen2	Screen3	Screen4	Screen5

Screen1 A-Scope	Screen2 A-Scope	Screen3 A-Scope	Screen4 A-Scope
Screen1	Screen2	Screen3	Screen4
Screen5			

Screen1 A-Scope	Screen1			
Screen2 A-Scope	Screen2	Screen3	Screen4	Screen5

Vertical division

Horizontal division

Mixed division

**SPECIFICATIONS OF FISH FINDER
FCV-38**

1 TRANSCIEVER UNIT

- 1.1 Transmitting frequency 38 kHz
- 1.2 Output power 4 kW
- 1.3 Number of channel 64 ch
- 1.4 Transmitting mode CW/FM
- 1.5 Transmit rate 1200 pulse/min. max.
- 1.6 Beam control range Bow/stern, port/stbd within 20°

2 PROCESSOR UNIT

- 2.1 Display range 10 to 3000 m
- 2.2 Range shift 2000 m max.
- 2.3 Expansion range 2 to 200 m
- 2.4 Display mode Single, Multi-beam combination, Zoom, External fish finder combination
- 2.5 Zoom display Bottom zoom, Bottom lock expansion, Marker zoom, Discrimination zoom
- 2.6 Advance speed Freeze, 1/16, 1/8, 1/4, 1/2, 1/1, 2/1, 4/1, 8/1 (Lines/TX)
- 2.7 Fish size histogram Display three points simultaneously
- 2.8 Alarm Bottom, Fish, Bottom fish, Water temperature, Fish size histogram
- 2.9 Language English (UK/US), Japanese
- 2.10 Display function (commercial monitor required)
 - Resolution 1920 x 1200 (WUXGA), 1920 x 1080 (FHD), 1600 x 1200 (UXGA), 1024x1280 (SXGA), 1024 x 768 (XGA)
 - Video output 2 ports, HDMI (Type-A)
 - Colors 64/16 (Echo)
 - Contrast Standard, #1 to #5 or User setting

3 INTERFACE

- 3.1 Number of port (processor unit)
 - Serial 5 ports, NMEA0183 V1.5/2.0/3.0
 - LAN 2 ports (for transceiver unit, external sounder/maintenance), Ethernet 10/100/1000Base-T
 - USB USB 2.0: 2 ch, USB 3.0: 2 ch
- 3.2 Data sentences
 - Input GGA, GLL, GNS, MTW, VHW, VTG, ZDA
GPatt, GPhve, IIDAD, IIDBS, IIHFB, IIMTW, IITPC, IITPT, MPMSD, pireq, SDDBS, SDfnz
 - Output DBS, DBT, DPT, MTW, TLL, SDbhr, SDflg, SDmrk, pidat

4 POWER SUPPLY

- 4.1 Processor unit 12-24 VDC: 4.0-2.0 A
- 4.2 Transceiver unit 100-120/200-240 VAC: 5 A max, 1 phase, 50/60Hz

5 ENVIRONMENTAL CONDITIONS

5.1 Ambient temperature

Processor unit -15°C to +55°C (storage: -15°C to +70°C)

Transceiver unit -10°C to +45°C (storage: -15°C to +70°C)

Control unit/Junction box -15°C to +55°C

Transducer -5°C to +35°C

5.2 Relative humidity 93% or less at +40°C

5.3 Degree of protection

Processor/ Transceiver unit IP22

Control unit IP22 (IPX0 w/o USB port cover)

Junction box IP20

Transducer IPX8

5.4 Vibration IEC 60945 Ed.4

6 UNIT COLOR

6.1 Transceiver unit/ Junction box

2.5GY5/1.5

6.2 Processor/ Control unit N2.5

INDEX

A

- ACCU-FISH 1-34
- Advanced settings menu 4-1
 - operation overview 1-14
- Alarm menu 4-6
- Alarms
 - activating, deactivating 1-37
 - overview 1-36
 - setting 1-38
- A-scope display 1-31

B

- Battery replacement 6-3
- Bottom discrimination display
 - examples 1-29
- Bottom lock mode 1-27
- Bottom zoom mode 1-28

C

- Calibration
 - calibration extraction area 5-14
 - fishing rod set up 5-3
 - measurement area 5-2
 - necessary parts 5-1
 - operations available after measurement 5-15
 - operations during measurement 5-13
 - overview 5-1
 - procedure 5-7
 - progress details window 5-14
 - standard sphere binding method 5-2
 - standard sphere set up 5-5
 - Calibration menu
 - external echo sounder menu 4-8
 - external fish finder 4-28
 - FCV-38 4-18
 - Calibration settings menu 4-19
 - Clutter
 - external fish finder window OFF 1-25
 - external fish finder window ON 1-25
 - FCV-38 1-24
 - Color bar on/off 1-33
 - Color erase
 - external fish finder window 1-42
 - FCV-38 1-41
 - Communication port monitor test 6-7
 - Control unit menu 4-16
- ## D
- Day and night color modes 1-30
 - Depth indication on/off 1-31
 - Depth measurement 1-32
 - Depth scale on/off 1-31
 - Display menu
 - external fish finder 4-25
 - FCV-38 4-3
 - Display modes

- external fish finder window 1-34
- FCV-38 1-11
- Display overview 1-2

E

- Error messages 6-5
- External echo sounder menu 4-6
 - calibration menu 4-8
 - sounder menu 4-7
 - TX/RX menu 4-9
- External fish finder
 - calibration menu 4-28
 - stabilization menu 4-29
- External fish finder window
 - description 1-33
 - display mode selection 1-34
- external fish finder window OFF 1-15

F

- Fish size graph
 - bottom trace 2-5
 - description 2-2
 - entire area 2-3
 - method of measurement 2-3
 - settings 2-7
 - showing, hiding 2-3
 - specific area 2-6
 - specific range 2-4
- Fish size menu
 - main 4-5
 - SIZE1 - SIZE3 menus 4-6
- Footer 1-5
- Fuse replacement 6-3

G

- Gain
 - external fish finder window OFF 1-18
 - external fish finder window ON 1-18
 - FCV-38 1-17
- Graphs
 - fish size 2-2
 - graph scale (target graphs only) 2-11
 - hardness graph 2-13
 - horizontal target graph 2-11
 - roughness graph 2-14
 - showing, hiding 2-1
 - sonde graph 2-12
 - temp graph 2-12
 - vertical target graph 2-10

H

- Hardness graph 2-13
- Header 1-4
- Horizontal target graph 2-11

- I**
- InstantAccess bar
 - icons description 1-7
 - overview 1-5
 - shortcuts 1-6
 - Interference
 - external fish finder window OFF 1-22
 - external fish finder window ON 1-22
 - FCV-38 1-21
- L**
- LCD test 6-10
 - Load settings 1-44
- M**
- Maintenance
 - battery replacement 6-3
 - fuse replacement 6-3
 - general 6-1
 - trackball 6-2
 - Maintenance information test 6-7
 - Marker zoom mode 1-28
 - Measurement menu (external fish finder) 4-25
 - Menu tree AP-1
 - Minute marker on/off 1-33
 - Mode menu
 - adding a mode 4-21
 - deleting a mode 4-22
 - editing a mode 4-22
 - overview 4-21
- N**
- Navigation data on/off 1-39
- P**
- Picture advance
 - external fish finder window ON 1-16
 - FCV-38 1-15
 - Playback (echo data)
 - procedure 3-6
 - Power on/off 1-2
- R**
- Range
 - external fish finder window OFF 1-20
 - external fish finder window ON 1-21
 - FCV-38 1-20
 - Range menu
 - external fish finder 4-26
 - FCV-38 4-10
 - Recording
 - external memory device 3-9
 - Recording (echo data)
 - procedure 3-5
 - recording format 3-5
 - Redo 1-46
 - Roughness graph 2-14
- S**
- Screenshots (still images)
 - copying 3-4
 - deleting 3-4
 - replaying 3-3
 - save destination 3-1
 - taking 3-2
 - taking at set interval 3-2
 - Scroll-back 1-40
 - Settings
 - loading 1-45
 - saving 1-44
 - Shift
 - external fish finder window OFF 1-19
 - external fish finder window ON 1-19
 - FCV-38 1-19
 - SIZE1 - SIZE3 menus 4-6
 - Smoothing
 - external fish finder window OFF 1-23
 - external fish finder window ON 1-24
 - FCV-38 1-23
 - Sonde graph 2-12
 - Sounder menu
 - advanced settings menu 4-2
 - external echo sounder menu 4-7
 - external fish finder 4-23
 - FCV-38 4-2
 - Split menu 4-12, 4-14
 - Split screen division 1-13
 - Stabilization menu
 - external fish finder 4-29
 - FCV-38 4-19
 - System configuration xi
 - System menu
 - calibration settings menu (FCV-38) 4-19
 - tests menu 6-6
 - System menu (external fish finder)
 - range menu 4-26
 - TX/RX menu 4-26
 - System menu (FCV-38)
 - control unit menu 4-16
 - range menu 4-10
 - tests menu 4-23
 - TX/RX menu 4-11
 - TX/RX menu, beam1 - beam5 menus... 4-14
 - TX/RX menu, split menu 4-12
 - user interface settings menu 4-17
- T**
- Temp graph 2-12
 - Tests
 - communication port monitor test 6-7
 - LCD test 6-10
 - maintenance information 6-7
 - trackball control unit 6-9
 - Tests menu 4-23, 6-6
 - TLL lines 1-40
 - Trackball Control Unit
 - maintenance 6-2
 - operation 1-1
 - test 6-9
 - Troubleshooting 6-4
 - TVG
 - description 1-42

INDEX

external echo sounder.....	1-43
external fish finder window.....	1-44
FCV-38.....	1-43
TX/RX menu	
external fish finder.....	4-26
FCV-38.....	4-11
TX/RX menu (external echo sounder menu)	
main.....	4-9
TX/RX menu (system menu)	
beam1 - beam5 menus.....	4-14
U	
Undo.....	1-46
User interface settings menu.....	4-17
V	
Vertical target graph.....	2-10
VRM.....	1-32
Z	
Zoom mode	
bottom discrimination.....	1-29
bottom lock.....	1-27
bottom zoom.....	1-28
marker zoom.....	1-28
selecting.....	1-26

The purpose of this guide is to provide the basic operation for this equipment.
All brand and product names are trademarks, registered trademarks or service marks of their respective holders.

Operator's Guide

Display Overview

Header: Click the scrollwheel then spin it to change the setting.

Various Settings Information: Displays the settings for the Interference Rejection, Smoothing, Clutter, Zoom Mode, Bottom Trace, Specific Area, External Fish Finder Gain¹ Setting

Display Mode² SB/B1

Picture Advance ADVANCE ← x1

Gain 2.0

Shift 0

Range 150

Current mode selection AT indication: Auto shift, Auto range active

Mode and Gain

Measurement range for fish graph 50

Instant Access bar™ See next page for description of 1-7.

670 Screenshots taken/Screenshot capacity 150

0/99 93%

2020/01/22 18:14:18

¹ External fish finder mode is disabled (at installation).
² SB: Split mode display
B1 - B5: Beams 1-5
BL: Bottom Lock mode
BZ: Bottom Zoom mode
MZ: Marker Zoom mode
BD: Bottom Discrimination
HE: External HF sounder
LE: External LF sounder

Fish Length Graph

Advance Settings Display button

Display Switch button

Average fish length 34.1 [cm]

DATA 143

Total no. of measurements

Distributed graph scale

First Peak³

Graph Scale

How to show the Fish Size Graph

The are four methods of measurement:

- Entire Area
- Specific Range
- Bottom Trace
- Specific Area

³ Estimated fish length which occupies the highest percentage in the measurement area.

Target Graphs

Vertical target graph

Scale button

Own ship icon

No. of times target center. Bottom: No. of times target is in the direction of rotation from bow.

Graph scale (degrees)

Circles denote echoes received in last three scans. Circle size indicates received order, largest circle=latest echo. Colors indicate strength; red, strongest, green, weakest.

Horizontal target graph

Scale button

Measurement area. The area changes shape according to measuring range.

Circles denote echoes received in last three scans. Circle size indicates received order, largest circle=latest echo. Colors indicate strength, red, strongest, green, weakest.

Graph scale (degrees)

When an external memory is connected: Shows the available space.
When an external memory is not used: Shows "0%".

"Pinned" icon: The footer is always visible when this icon is active. When deactivated, the footer is hidden until the cursor is placed on the footer's location. (The header also has this icon.)

Icons on InstantAccess bar™

The color of an icon changes according to function status.



① [Sounder] menu: Access the sounder-related settings.

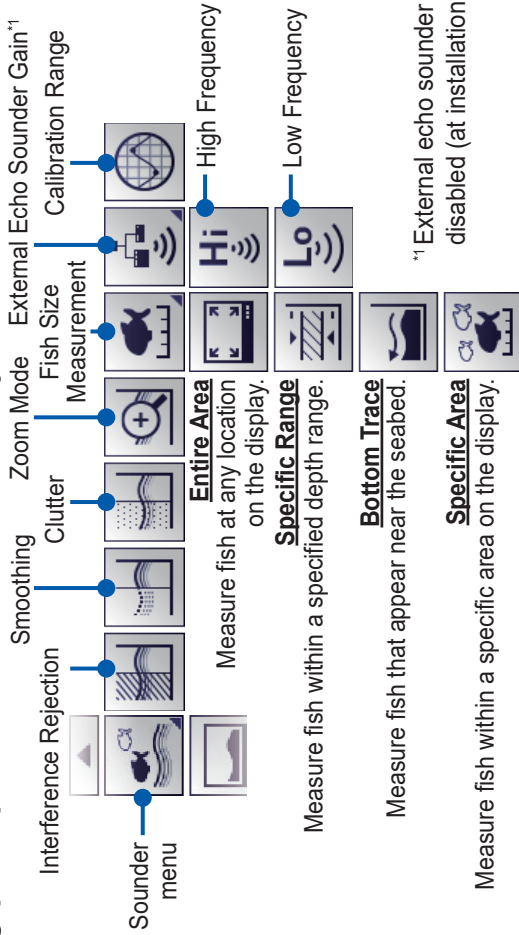

¹ External echo sounder mode is disabled (at installation).

② [Display] menu: Access the display-related settings.

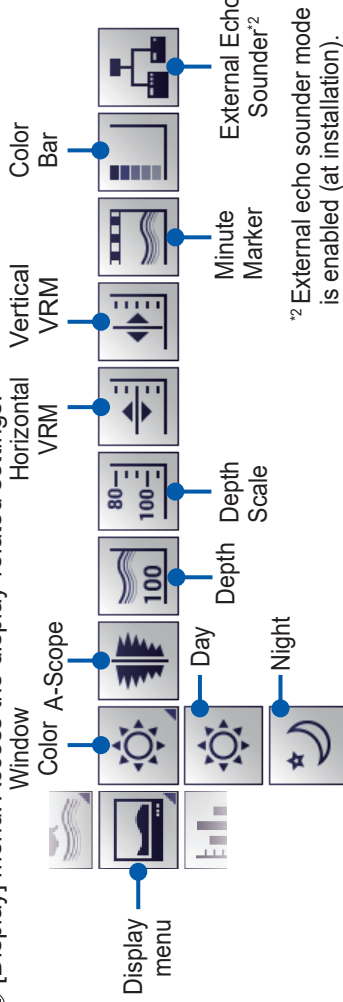

² External echo sounder mode is enabled (at installation).

③ [Graph] menu: Show or hide the graphs.

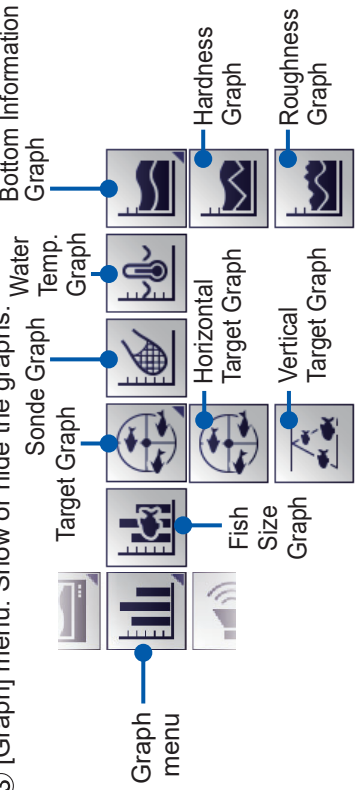

④ [Alarm] menu: Activate/deactivate alarms.

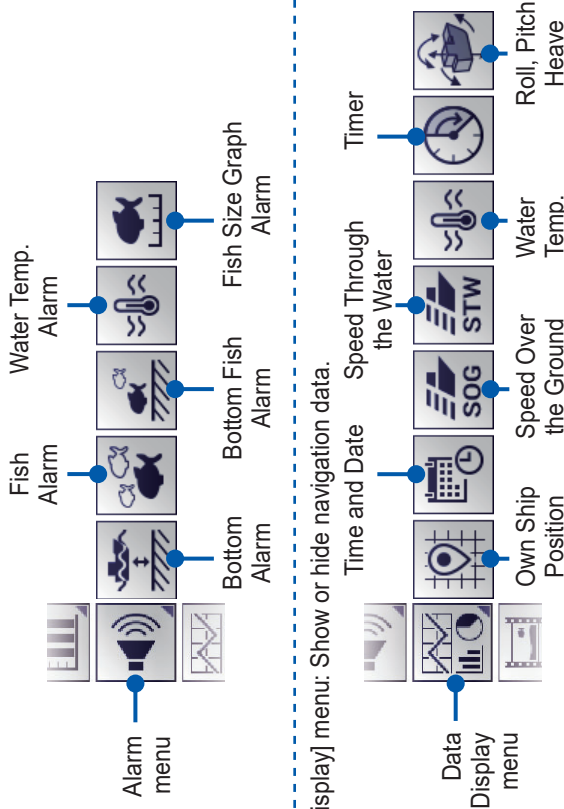

⑤ [Data Display] menu: Show or hide navigation data.

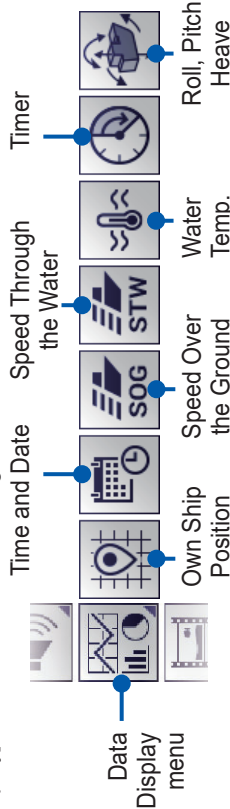

⑥ [Echo Recording] menu: Access the echo recording and image recording functions.

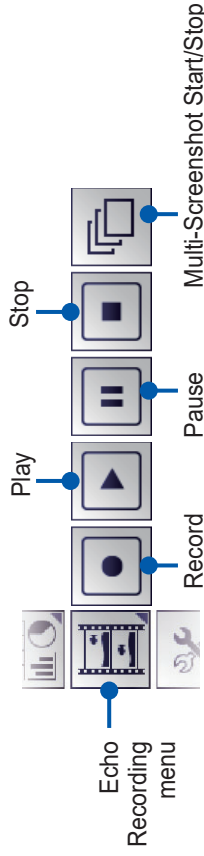

⑦ [Advanced Settings] menu: Access the advanced settings menu, change various settings, and undo/redo actions.

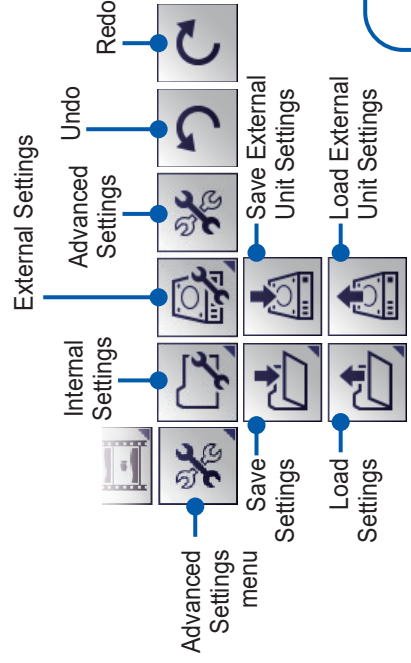



Declaration of Conformity



We **FURUNO ELECTRIC CO., LTD.**

(Manufacturer)

9-52 Ashihara-Cho, Nishinomiya City, 662-8580, Hyogo, Japan

(Address)

declare under our sole responsibility that the product

FISH FINDER FCV-38

(Model name, type number)

to which this declaration relates conforms to the following standard(s) or other normative document(s)

EU

EMC Directive 2014/30/EU

IEC 60945 Ed.4.0: 2002

For assessment, see

- Test report
Labotech International Co., Ltd.
LIC 12-19-162, 24 Oct 2019
LIC 12-19-182, 24 Oct 2019

UK

SI 2016 No.1091 EMC Regulations 2016 as amended

EN 60945: 2002

For assessment, see

- Test report
Labotech International Co., Ltd.
LIC 12-19-162, 24 Oct 2019
LIC 12-19-182, 24 Oct 2019

(title and/or number and date of issue of the standard(s) or other normative document(s))

On behalf of Furuno Electric Co., Ltd.

Nishinomiya City, Japan
26 July 2021

(Place and date of issue)

Akihiko Kanechika
Department General Manager
Quality Assurance Department

(name and signature or equivalent marking of authorized person)