

FURUNO

NAVnet DE



POWERED BY **MAXSEA**

WWW.NAVNET.COM



Adding a New Dimension to 3D

The world of onboard navigation systems has evolved. The desire for faster redraw rates and a more instinctively clear user-interface have been heard and answered. FURUNO's dedication to deliver the best marine electronics has led to the most innovative, powerful solution for onboard navigation ever.

Prepare yourself for a revolution. Introducing NavNet 3D.

POWERED BY **MAXSEA**



FURUNO

742

12.6 RAG
295.3 RYG



Steer To
293.7 °T

XTE
9 m

Distance
1.129 nm

TTG
6m46

COG
293.3 °T

Heading
293.7 °T

Auto

3D

Track

1.5

93.3
0.0

24.84

1.129 WPT
6m46s TTG

GO TO LIST

POINTS ROUTE

CANCEL

DISP

CTRL

SAVE MOB

CURSOR

DATA VOL

MENU

OUT RANGE

IN

SCROLLING SHIP 3D

BRIGHT



FURUNO's NavNet 3D redefines the user interface of onboard navigation systems.

FURUNO's new NavNet 3D is a groundbreaking navigation system that introduces new concepts for a user interface that makes navigating your vessel easier than ever before. Once you start using NavNet 3D, you will be amazed at how a system so powerful can be so simple to use. NavNet 3D comes fully loaded with a variety of groundbreaking, new features that will expand your navigational horizons.



The only acceptable wait time is zero, TimeZero™.

NavNet 3D uses a new cutting-edge technology called "TimeZero™". It facilitates seamless chart redraw, allowing zooming, chart panning, changing chart display modes and other chart handling functions without limited range presets. TimeZero™ brings you a truly seamless navigation environment you have to see to believe. For the ultimate in flexibility and the fastest NavNet 3D redraw, look to the Black Box series (MFDBB), which features a super-charged graphics processor.



True 3D environment for a more instinctive chart presentation.

NavNet 3D incorporates a whole new dimension into chart presentation with full time 3D chart rendering. You can choose a 2D top-down view of the navigation chart for a look and feel that duplicates a traditional chart plotting presentation. Or, you can choose to pan and zoom the chart to any angle at any range scale you choose instantly. There is no "3D mode" to change into and no waiting, because NavNet 3D operates in the true 3D environment full time. Plus it is pre-loaded with full-scale, complete NOAA raster and vector chart libraries for the entire U.S. coastline, including Alaska and Hawaii! To top it off, you can combine them with new Satellite PhotoFusion™ charts. This variety of chart presentations helps to improve your situational awareness by giving you unprecedented control over your charting environment.

NavNet 3D RotoKey™ puts a whole new spin on "User Friendly"

NavNet 3D challenges a conventional menu operating system with a whole new concept, the "RotoKey™" on-screen revolving menu key. By turning a rotary knob on the control panel, RotoKey™ will be activated, giving you full access to NavNet 3D controls.



NavNet 3D Cartography

NavNet 3D's powerful graphic engine has added new chart presentation options to the conventional 2D method of chart plotting. With 3D charts and our new Satellite PhotoFusion™, you can now blend satellite imagery with critical chart data like never before. These new presentation options allow you to visually identify the exact position of your vessel, together with information about the surrounding area on instinctively clear chart orientations that you control.

Navigate in True 3D with NOAA Raster, Vector or optional "C-Map by Jeppesen"*and "Datacore by Navionics" Vector and Bathymetric Charts

NavNet 3D incorporates native 3D chart architecture that allows for a full-time 3-dimensional presentation, as opposed to 2D charts that require special effects to appear 3D. There are no special modes; that limit your ability to navigate the way you want. With NavNet 3D's true 3D environment, you can see all of the information you want with no limitations on what information you wish to view. Plus, it is pre-loaded with full-scale, complete raster and vector chart libraries for the entire U.S. coastline, including Alaska and Hawaii. Overlay a variety of data with a touch of the Rotokey, such as Radar overlay, Sirius Satellite Weather, AIS targets, ARPA targets plus all of your chart symbols and depth soundings. This is the beauty of navigating in NavNet 3D, you have full control over the presentation at all times.



NOAA 3D Raster

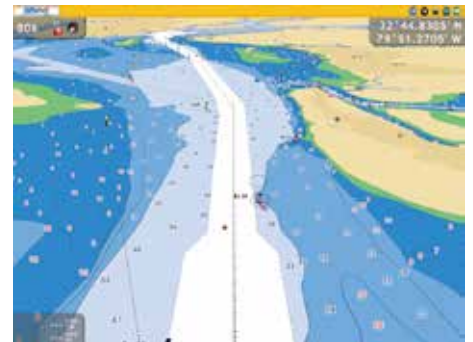

C-Map by Jeppesen 3D Vector*

** For detailed information, please refer to page 17-18.*

Satellite PhotoFusion™

Our high-resolution satellite photography can now be fused with raster or vector chart information. Land areas (zero depth) are completely opaque, so that these areas are displayed as high-resolution satellite photos on the chart. As the depth increases, the satellite photography becomes more transparent so that you will know where the shallows end and the deeper water begins, allowing you to navigate on the raster or vector chart. High-resolution satellite photography aids in seabed classification so that you will be able to easily identify areas of sand, rock, coral or other obstructions.



Satellite & Raster/PhotoFusion™



3D Key

Even though your raster or vector charts are operating in their native 3D environment full-time, one long press of the 3D key will toggle the chart from a familiar 2D top-down perspective, to your favorite 3D angle.



Satellite & 3D chart orientation

The Only Acceptable Wait Time is Zero: TimeZero™ Technology Changes Your Perspective on Chart Redraw

NavNet 3D's new TimeZero™ technology delivers chart processing like you've never seen before – seamless chart handling, zooming and panning without the screen disappearing.

TimeZero™ technology redefines the meaning of stress-free operation by smoothing out your chart handling actions. For the ultimate in chart redraw, step up to the NavNet 3D Black Box.

Chart scaling without limitation

Zoom seamlessly and continuously to whatever chart scale you desire. Instead of limiting you to a small handful of chart scales to choose from like traditional chart plotters, TimeZero™ architecture allows you to seamlessly zoom in or out to the exact magnification level you like without steps or limitations.

NAVnet
3D

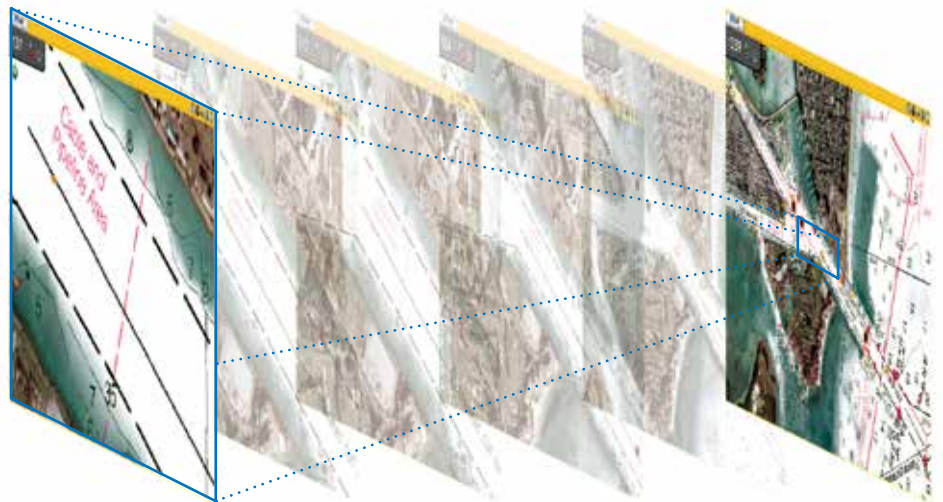

Smooth scaling delivers any range scale you desire.

Conventional Chart Plotter

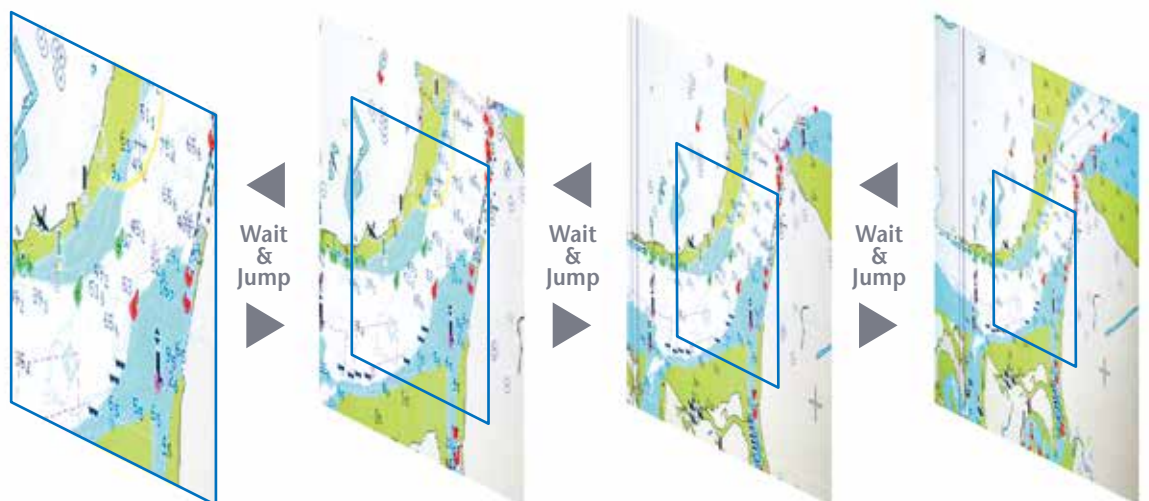

Conventional chart plotters have fixed range scales that you select from.



Easy chart panning gives you freedom to explore

You can pan the chart by simply pressing the scrolling pad. This gives you freedom to explore the chart data, allowing you to focus on a specific area ahead of or around your vessel without losing track of your position on the chart. Explore the chart data at your leisure, and then instantly return to own ship at the touch of a single dedicated ship button. Displaying True and Relative Motion is now more intuitive than ever before. TimeZero™ technology provides a useful utility for focusing on a specific direction such as the area ahead of your vessel.

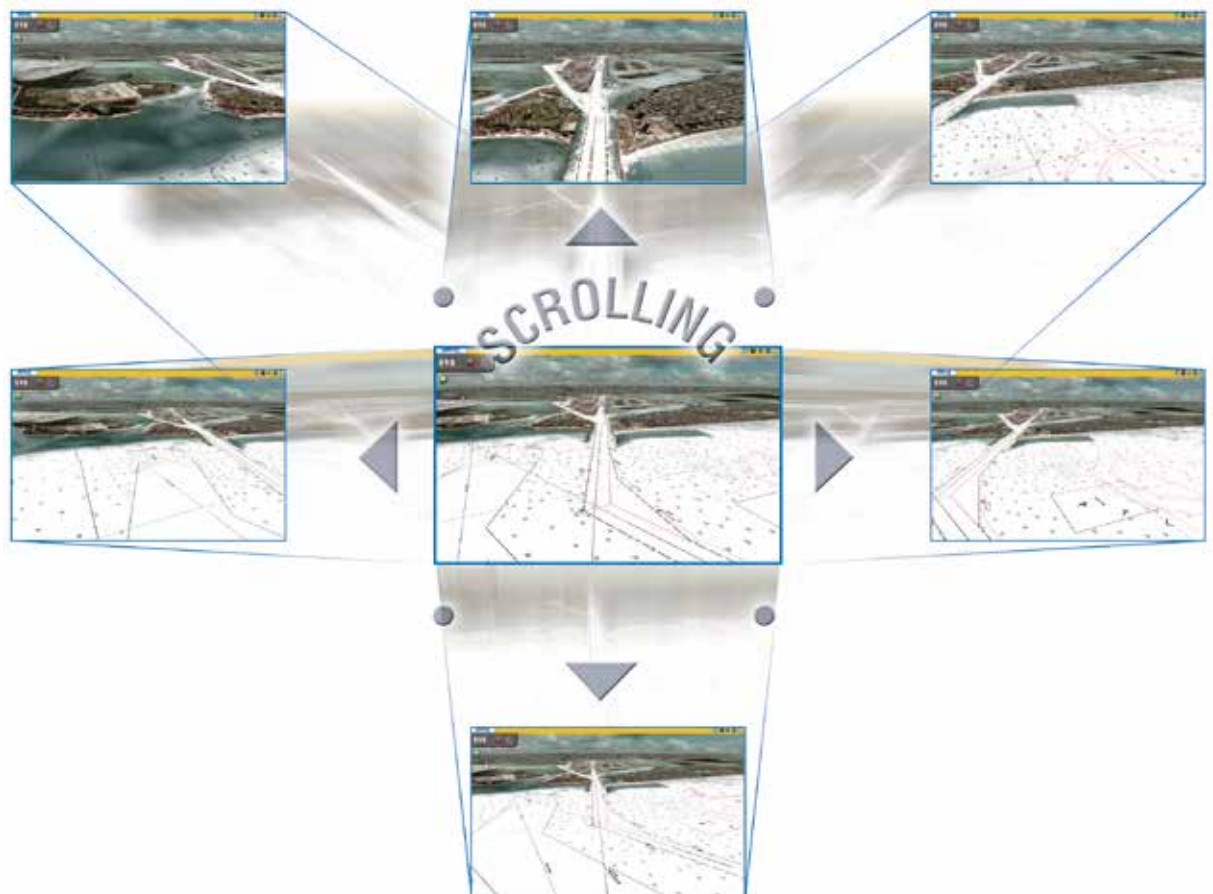

Scalable Operating System

NavNet 3D is designed with a user-friendly, scalable operating environment, accommodating new boaters as well as experienced navigators. It lets you customize your control of the system.

1 Point & Shoot Interface

NavNet 3D allows for a more straightforward user interface with a combination of both RotoKey™ and a familiar point-and-shoot cursor pad control. The power of the point-and-shoot interface allows for incredibly simple operation - click anywhere on the screen for context-sensitive options for that area. Click on any data box to access detailed information for that function. A variety of features can be accessed through a familiar left or right click interface. You can also connect a generic USB mouse to further simplify operation.

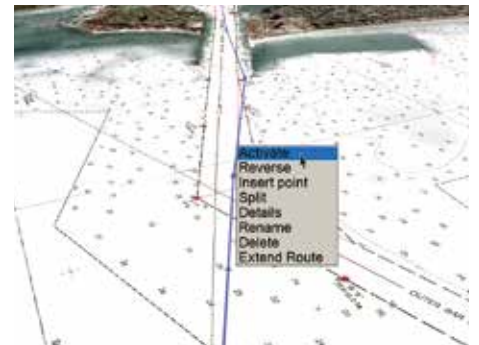

2 Disp Key

One press of the Disp key allows you to easily select the presentation you desire. Five intelligently designed hot-pages are available to you right out of the box, with the ability to save up to ten custom hot-pages. Customize any hot-page with a simple long press of the RotoKey™, which launches the hot-page wizard.

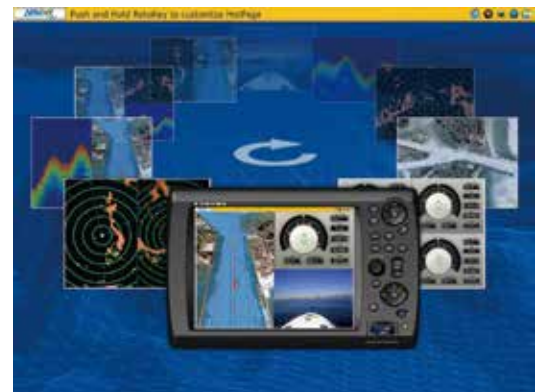



3 RotoKey™

This is NavNet 3D's revolutionary new control that merges the power and versatility of soft keys with an easy-to-use rotary knob! One turn of the RotoKey™ gives you instant access to full control of NavNet 3D. The RotoKey™ is designed as a part of NavNet 3D's scalable operating system; a short press of the RotoKey™ gives you access to a user-selected set of the functions that you select upon installation from Basic, Standard, Full or Custom, while a longer press of the key displays all of the functions available. Never leave your navigation screen to enter a menu again!



4 Range Key

A simple press of the Range key allows you to adjust the chart/radar range scale of your choice with ultra smooth zooming-in/out actions – thanks to TimeZero™ technology.

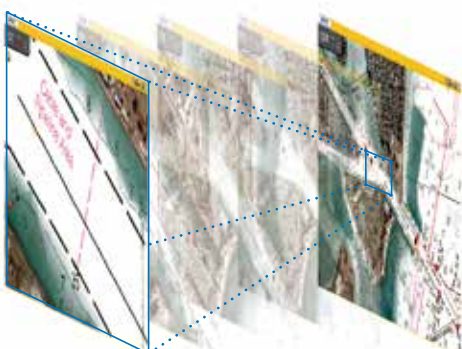

5 Scrolling Pad

The scrolling pad allows independent scrolling and panning capabilities from a dedicated omni-pad. Pan the chart or shift the radar quickly and seamlessly. You can also control Axis IP cameras without accessing complicated menus or changing your current presentation.



6 3D Key

One long press of the 3D key will toggle the chart from 3D to a familiar 2D, top-down perspective. While the chart remains in its native 3D environment, only the perspective shifts. Press the key again and you toggle back to 3D. There is no special mode required to shift back to 3D perspective.



FURUNO's NavNet 3D Digital Solution sets a new Stan

NavNet 3D operates on a fully digitized environment with its highly sensitive digital sensors for radar and fish finder. The operating structure is also digitized, delivering total fusion of hardware and software modules in its operation scheme, utilizing Ethernet, NMEA0183 and CAN bus interface.



ard

New Ultra High Definition (UHD™) Digital Radar

NavNet 3D integrates Ultra High Definition (UHD™) Digital Radar that facilitates fully automatic, high-precision Gain and Sea Clutter and Tuning Control for hands-free operation and ultimate performance. One of the amazing features of FURUNO UHD™ Digital Radar is a fully independent “Real-Time” dual range radar display, which scans and displays two different radar ranges simultaneously with no lag at all. UHD™ Digital Radar is fully integrated into NavNet 3D’s revolutionary TimeZero® technology, facilitating real seamless radar zoom without any display blackout*. Also, the high-resolution radar image can perfectly be overlaid with NavNet 3D’s native 3D chart in both 2D and 3D formats. All of these greatly enhance your situational awareness.

*NavNet 3D BlackBox (MFDBB) only

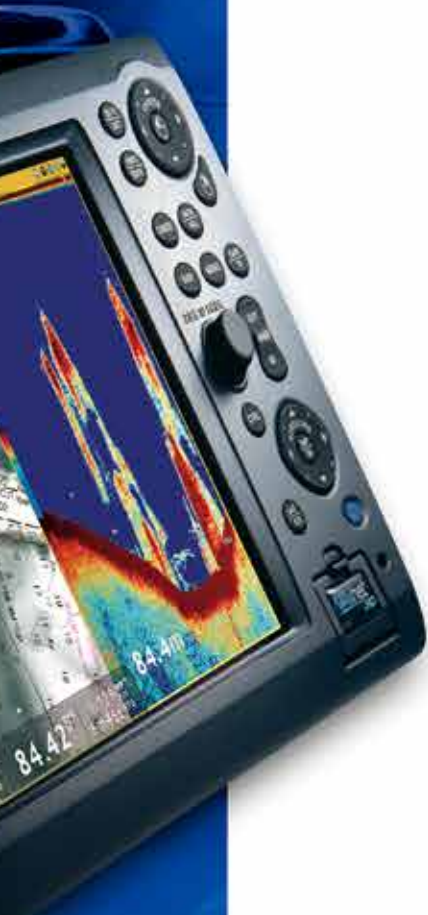
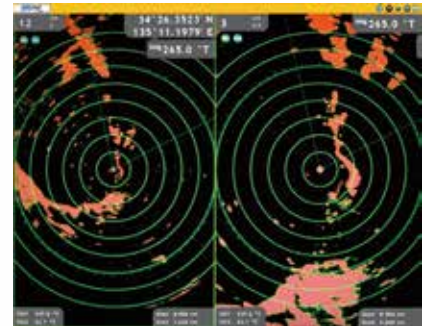

FURUNO Digital Filter (FDF™) Fish Finder

You probably know about digital fish finders, but are not quite sure what the term really means. FURUNO Digital Filter (FDF™) fish finders feature advanced filtering capabilities and digital auto tuning, which eliminates noise, while delivering the ability to spot individual fish with clarity, accuracy and detail. Whether it is used for shallow or deep water, FURUNO FDF™ fish finder gives you what you would expect from a fish finder at all times.



Enhanced shallow water detection by suppressing surface clutter.



DFF1

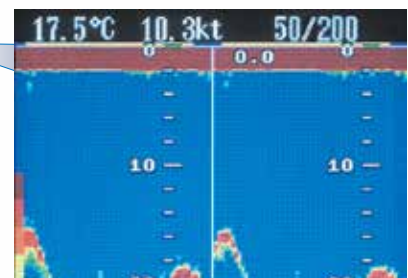

Conventional fish finder

NavNet 3D Digital Sensors

The reliability of NavNet 3D lies in its exceptional sensor performance, which is the result of advanced Digital Signal Processing. NavNet 3D digital Radar and Fish Finder sensors greatly improve target detection and presentation capabilities.

Ultra High Definition (UHD™) Digital Radar

FURUNO has taken its NMEA award-winning radar technology to the next level with Ultra High Definition Digital Radar. UHD™ offers crystal clear, target presentation with automatic real-time digital signal processing. Antenna rotation speed (24/36/48 rpm) is automatically shifted to the appropriate pulse length. Commercial-grade radar performance is now available in the ultimate MFD navigation suite.



NavNet 3D Real-Time Digital Auto Gain/Sea Clutter Controls

NavNet 3D employs revolutionary real-time digital auto Gain/Sea controls to deliver crystal clear radar presentation. With this new technology, NavNet 3D computes and applies an adaptive omni-directional anti-clutter filter with variable intensity depending on bearing.



Auto Gain/Sea Controls On



Auto Gain/Sea Controls Off



Auto Gain/Sea Controls On

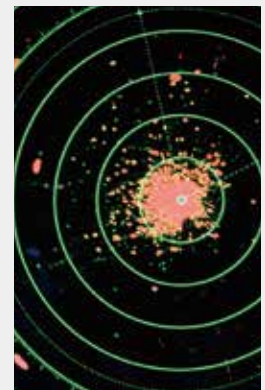

Auto Gain/Sea Controls Off

Real-time Dual Range Radar

NavNet 3D's simultaneous scanning technology drives our powerful dual-range radar, providing unsurpassed target detection. With each sweep of antenna, dual progressive scan transmissions are sent, received and processed to display two separate radar ranges on your NavNet 3D display simultaneously. Each radar presentation acts autonomously, allowing for manipulation of individual gain and clutter controls.

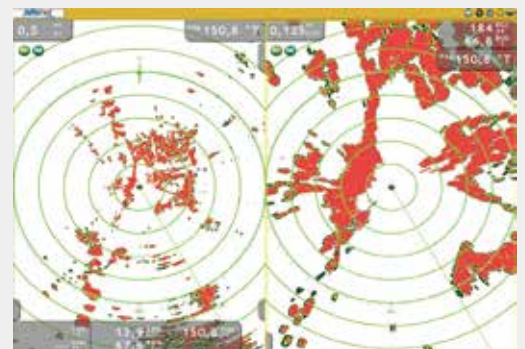



FURUNO Digital Filter (FDF™) Fish Finder

FURUNO's DFF1 and DFF3 and new BBDS1 (available Late 2010) feature the FURUNO Digital Filter (FDF™) technology. These new digital Network Sounders can turn any NavNet display into a powerful, dual frequency digital fish finder.



The main difference between digital and conventional fish finders lies in the filtering capabilities and auto adjustments. Our award winning FDF™ technology helps to optimally adjust gain, STC (Clutter) and output power as well as suppress surface clutter. It also makes the picture clearer and easier to decipher. However, even the best digital filter won't help unless you start with a solid basis, such as FURUNO's renowned fish finder technology. This is why FURUNO has been the best friend of fishermen for generations.

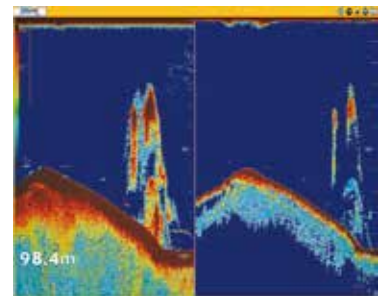

Bottom Discrimination Display (with BBDS1 only)*

NavNet 3D can show the bottom discrimination at the lower end of the fishfinder display, utilizing input from new Network Fish Finder BBDS1 (available Late 2010). Bottom discrimination will be shown in the following four categories; "Rock", "Gravel", "Sand" and "Mud", either in dedicated graphics or colors. This information is helpful in spotting the rich fishing ground where you can boost your catch of the day. There are two bottom discrimination display modes selectable:

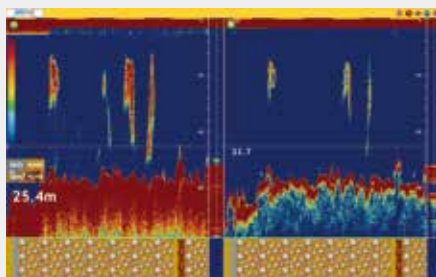

Standard mode:
Only the most prominent bottom category of the spot will be displayed.

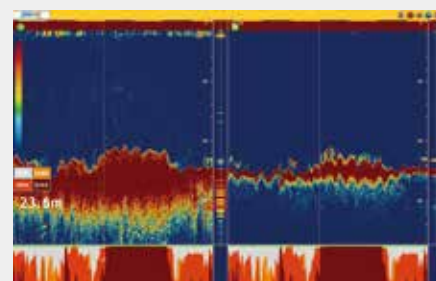

Probability mode:
The proportion of the bottom sediment of the spot is displayed in graph.

* Bottom discrimination display mode can be used in the following conditions:
Water depth: 5 m and deeper**

** The depth discrimination above is the rough idea of depth limit by which the Bottom Discrimination Display function can be used with a Thru-Hull transducer. Also, please note that the Bottom Discrimination function may not work properly when there is excessive noise or bubbles underneath.

NavNet 3D Network: Building Block Solution

NavNet 3D is built on an Ethernet network, allowing you to add as few or as many components as you desire along with up to ten displays to create your perfect navigational suite. Further, you can connect NMEA0183 and CAN bus devices to any display or BB processor and share that information across the Ethernet network automatically. User setting data can also be transferred by using SD cards for synchronization of operation settings amongst networked displays. Power on/off synchronization amongst all of the NavNet 3D display units can be



RADAR



ARPA Radar FAR-2xx7 Series

FURUNO ARPA/RADAR Series FAR-2xx7 can be connected to NavNet 3D through the Ethernet data link.



Radar Sensors

FISH FINDER



Network Fish Finder DFF1/DFF3



Color LCD Sounder FCV-1150

All the NavNet 3D radar sensors incorporate a CAN bus port to which certain CAN bus/NMEA2000 sensors can be directly connected. Power for these networked sensors is supplied directly from the radar itself. This unique feature allows for flexible installation of multiple CAN bus/NMEA2000 sensors without the need to run cables all the way to the main processor unit. CAN bus/NMEA2000 data is converted and distributed throughout the NavNet 3D Ethernet network.

GPS



GPS/WAAS Antenna GP-330B

GPS



GPS Navigator GP-33

GPS



GPS/WAAS Antenna BBWGPS

Contact

External alarm output & point/
MOB alert input













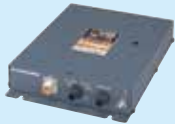



MOB Pendant System Ready

Any NN3D system is compatible with every Wireless MOB Pendant System through the MOB Contact Closure Input.

achieved when the dedicated Ethernet hub HUB101 is used.

The NavNet 3D system is built upon the most advanced chart plotter technology. Add to this UHD™ Radar and FDF™ Fish Finder, along with your choice from a wide variety of sensor options and up to ten displays. In addition, FURUNO's NAVpilot autopilot can also be connected to the system. It is easy to see how the basic chart plotter display becomes the genesis of the most sophisticated navigational suite available.

<p>AIS</p>  <p>AIS Receiver FA-30</p>  <p>Class-B AIS Transponder FA-50</p>	<p>FAX</p>  <p>Network Weather Facsimile Receiver FAX-30</p>	<p>PC</p>  <p>MAXSEA TimeZero Explorer PC Software</p>	<p>CAMERA</p>  <p>IP Camera</p>	<p>SENSORS</p>  <p>Network Satellite Weather Receiver BBWX1</p>
<p>INSTRUMENTS</p>  <p>FI-70</p>	<p>AUTOPILOT</p>  <p>NAVpilot-711C</p>  <p>NAVpilot-700</p>	<p>COMPASS</p>  <p>Integrated Heading Sensor PG-700</p>	<p>DISPLAY</p>  <p>Remote Display RD-33</p>	 <p>Depth/Speed/Temp Sensor DST-800</p>
		 <p>Satellite Compass SC-30</p>  <p>Satellite Compass SC-50/110</p>  <p>Integrated Heading Sensor PG-500R</p>		

***What is CAN bus?**

CAN bus is a communication protocol that shares multiple data and signals through a single backbone cable. You can simply connect any CAN bus devices onto the backbone cable to expand your network onboard. With CAN bus, IDs are assigned to all the devices, and status of each sensor in the network can be detected. All the CAN bus devices can be incorporated into the NMEA2000 network.

CHART PLOTTER

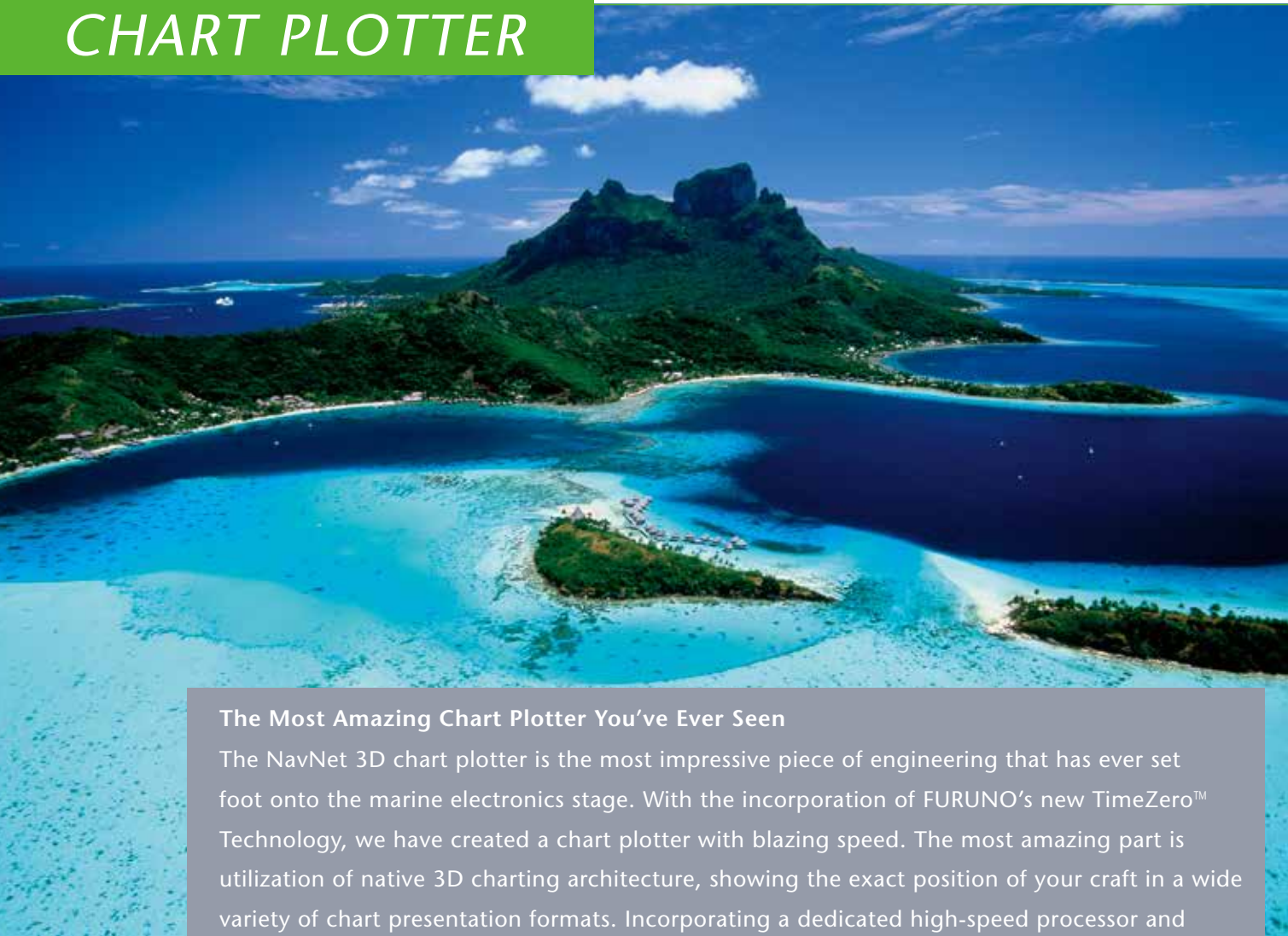

The Most Amazing Chart Plotter You've Ever Seen

The NavNet 3D chart plotter is the most impressive piece of engineering that has ever set foot onto the marine electronics stage. With the incorporation of FURUNO's new TimeZero™ Technology, we have created a chart plotter with blazing speed. The most amazing part is utilization of native 3D charting architecture, showing the exact position of your craft in a wide variety of chart presentation formats. Incorporating a dedicated high-speed processor and powerful graphic engine, NavNet 3D delivers unprecedented levels of performance and utility by seamlessly integrating diverse, essential navigational data.

NavNet 3D further expanded its chart versatile chart plotter with the addition of "C-Map by Jeppesen" charts*

NavNet 3D is the only chart plotter on the market providing users the ability to choose from pre-loaded official NOAA raster and vector charts, or optional "C-Map by Jeppesen"* and "Datacore by Navionics" vector cartography. Fully integrating the cutting-edge data analytic algorithm together with high-resolution image processing technique, Mapmedia delivers digital navigation charts and satellite photography with absolute clarity and details. Mapmedia vector and raster charts are built upon 3D architecture, which is smoothly integrated with NavNet 3D's TimeZero™ technology.



Mapmedia Raster

Raster charts are digitized scans of NOAA paper charts. For the traditionalist who is used to the touch and feel of a paper chart, Mapmedia raster is the option for you. Unlike conventional raster charts, high-resolution scans have been applied to Mapmedia raster so that the chart quality will not deteriorate even when viewed at the smallest of range scales.



Mapmedia Raster



Radar-Chart overlay

Mapmedia Vector

Vector charts contain a huge volume of information in different layers, each of which can be selectively displayed. As you zoom into the chart, increasing levels of detail can be seen without any sacrifice in image resolution.



Mapmedia NOAA Vector



NOAA Vector + Satellite PhotoFusion™

NavNet 3D now offers three different sources of vector chart options with the addition of C-Map by Jeppesen*. Optional "C-Map by Jeppesen" vector cartography* delivers a wealth of important chart detail for navigation, including spot soundings and depth contours.



**A software update (v2.05) will be necessary to use the new "C-Map by Jeppesen" charts, which will be available for download at Furuno's web site (www.FurunoUSA.com).*

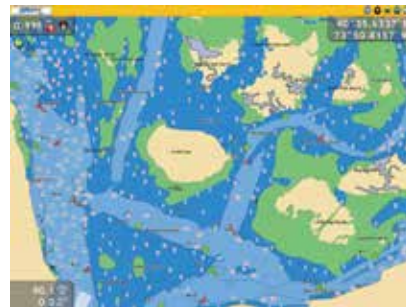

Mapmedia C-Map by Jeppesen 2D Vector



C-Map by Jeppesen 3D Vector + Satellite PhotoFusion™

Satellite PhotoFusion™

You can load any two ultra-wide high-resolution satellite photo areas at your convenience. These satellite photos are at the highest resolution available on the market today and they cover the entire U.S.

Satellite fusion with raster or vector charts is a feature available only with FURUNO's NavNet 3D. Land areas (zero depth) are completely opaque, so that these areas are displayed as high-resolution satellite photos on the chart. As the depth increases, the satellite photography becomes more transparent so that you will know where the shallows end and the deeper water begins, and also allowing the raster or vector chart to be visible.

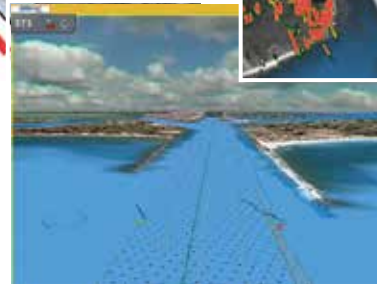

On top of the bundled cartography and satellite photography, you can save the following marks and points in the NavNet 3D internal memory:

- ▶ up to 10,000 ship's track points;
- ▶ up to 2,000 points and
- ▶ 200 planned routes, within which up to 100 waypoints can be placed.

Depth Shading

A depth color scale can be applied on both 2D and 3D vector and raster charts. Transparency levels can be adjusted so that the chart data is visible beneath the color shading. This unique feature allows you to view water depths at-a-glance with vibrant colors. No more searching for depth numbers, when you can simply set depths to your specified colors. Whether you want to see the depth for navigation or fishing purposes, this new feature makes it easier than ever.

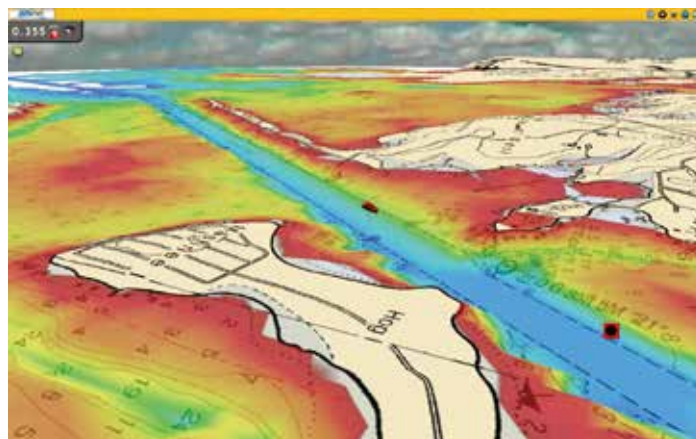
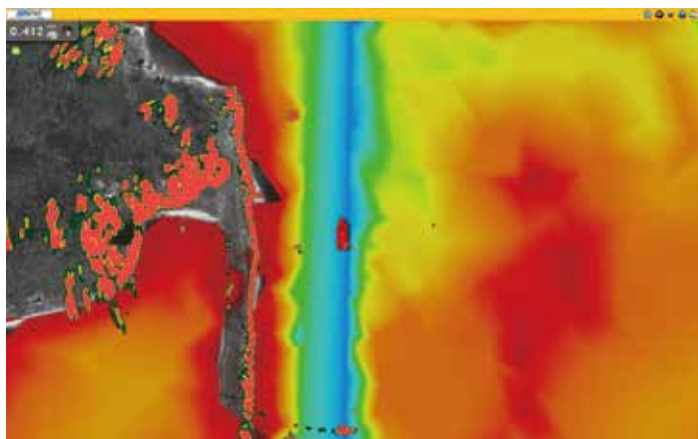

Preloaded Tides and Currents information

NavNet 3D also comes preloaded with global tide and current information, which can be overlaid onto the chart display.

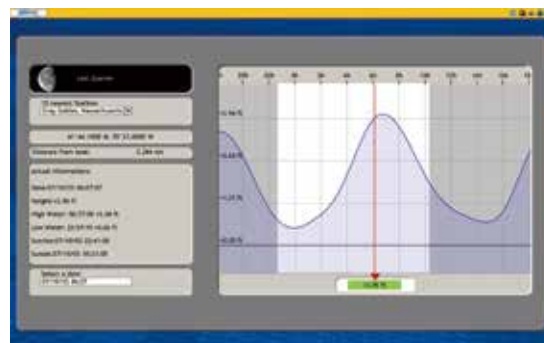

1 Tide Symbol

Tide symbols are located where tidal recording stations are. When you place your cursor over the tide symbol, the symbol is magnified. By selecting a tide symbol, you can view a graph with predictions for minimum/maximum tidal height as well as times for sunset and sunrise.



2 Current Indicator

Arrows indicate current direction, while size and color indicates current speed.



NAV Data Display and Engine Monitoring

NAV Data Display

Selected NAV data can be shown at the edges of the screen in nav data windows.



1 Range Data

Automatically changes range scale settings between long range (mile, nautical mile or kilometer) and short range (foot, meter or yard) according to the current display range.

2 Cursor Data

Shows the latitude and longitude position where the cursor is on the chart.

Information to be displayed

- ▶ Position
- ▶ Range
- ▶ Bearing

3 Ship's Data

These user-specified data boxes allow you to display the information you want to see. Customize the data boxes to show single or multiple pieces of information. Click on the box and it will show you the variety of data you can display. When you select multiple data, it will rotate at a specified time interval.

Information to be displayed

- ▶ Position
- ▶ COG
- ▶ SOG
- ▶ Depth
- ▶ SST
- ▶ STW
- ▶ Heading
- ▶ True Wind Speed
- ▶ True Wind Direction
- ▶ True Wind Angle
- ▶ Apparent Wind Speed
- ▶ Apparent Wind Angle
- ▶ ROT
- ▶ Trip Log
- ▶ Odometer
- ▶ Date and Time

On-screen Navigational Instrument

NavNet 3D delivers various on-screen navigation instrument displays.



1 Compass Rose display

In the Compass Rose display, you can view the heading, bearing to the waypoint and COG information at the same time in order to see if your craft is on the right track.

2 Engine Monitoring

When interfaced with the engine that outputs data in the NMEA 2000 format, NavNet 3D can show an on-screen engine monitoring display. The information to be displayed includes tachometer, boost pressure, engine temperature and oil pressure.

3 Wind Speed and Direction

Either true or apparent wind speed and direction can be shown, when interfaced with a wind sensor.

RADAR

NavNet 3D Radar

NavNet 3D's new Ultra High Definition (UHD™) Digital Radar technology sets a new standard in marine radar. With a highly advanced digital sensor and signal processing technologies, UHD™ Digital Radar greatly enhances situational awareness.



Real-time Dual Range Radar presentation with Dual Progressive Scan

NavNet 3D's simultaneous scanning technology allows dual progressive scan to display and update two radar pictures, both long and short range, at the same time as opposed to alternate update methods of typical conventional dual range radar. Autonomous control over gain and anti-clutter can be performed on each radar presentation. This can be used to have one screen with the gain set to locate birds and buoys, while you use the other radar screen to navigate.

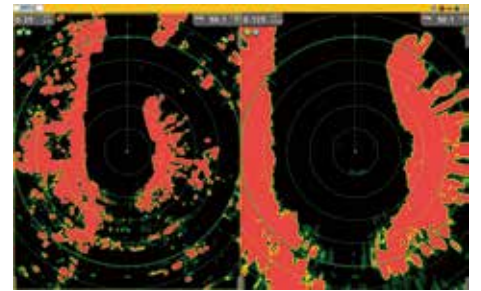

Radar-Chart overlay

Radar image of spot-on accuracy can be overlaid with chart information. Not only is it done with the conventional 2D chart format, but also it can now be projected onto 3D chart presentation! Radar range scales in the radar-chart overlay entirely depend on the range scales in the chart presentation, allowing you to view the radar image on the chart information in whatever magnification level you desire. (An appropriate heading sensor is required.)

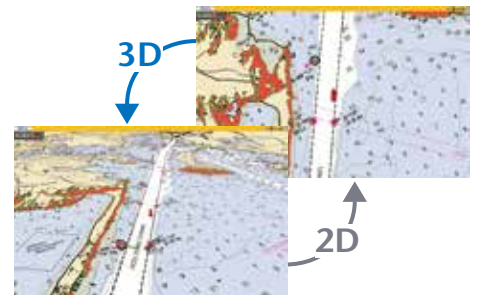

ARPA/AIS target tracking

Automatic radar plotting utility is one of the standard features of the NavNet 3D radar. Up to 30 targets can be simultaneously acquired and tracked for heading and speed. AIS target tracking is accomplished when interfaced with a FA-30/50/150 AIS unit.

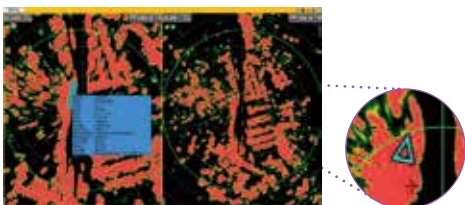

Real-Time Digital Auto Gain/Sea Controls

NavNet 3D employs revolutionary real-time digital auto Gain/Sea controls to deliver a crystal clear radar presentation. With this new technology, NavNet 3D computes and applies an adaptive omni-directional anti-clutter filter with variable intensity depending on bearing.

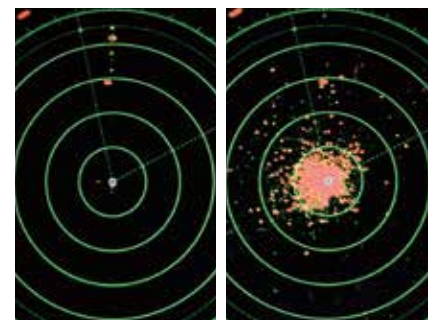

Auto Gain/Sea Controls On

Auto Gain/Sea Controls Off

Auto Gain/Sea Controls On Auto Gain/Sea Controls Off



- ▶ Enhanced detection both in long and short range by Digital Radar Sensor
- ▶ Seamless zoom in/out of radar range scales (MFD8/12)
- ▶ Enhanced auto tuning, auto gain and anti-clutter controls
- ▶ 48 rpm antenna rotation speed for HSC and river applications
- ▶ Adaptive antenna rotation speed according to pulse length
- ▶ Accurate radar overlay on both 2D/3D chart presentation with aid from heading sensors
- ▶ True echo trail shows afterglow of moving radar targets
- ▶ True Color Radar shows density of targets
(32 color levels for the MFD8 and MFD12, 256 color levels for the MFD8/12)
- ▶ Radar Guard Zone and Watchman features alert you to potential danger
- ▶ Dual VRM (Variable Range Marker) and dual EBL (Electric Bearing Line)
- ▶ Off-center display capability allows you to focus on specific direction with a simple press of the cursor pad
- ▶ Automatic IP address assignment for true Plug and Play installation



Radar Sensors

The NavNet 3D radar processor is incorporated into a radome antenna or gearbox. Simply plug in Ethernet and power cable connectors and you will have digital radar sensor within your NavNet 3D network. The IP address is automatically assigned to the radar sensor for true Plug and Play installation.

NavNet 3D Radar Sensor Options

	DRS2D	DRS4D	DRS4A	DRS6A	DRS12A	DRS25A
Output Power	2.2 kW	4 kW	4 kW	6 kW	12 kW	25 kW
Size	19 inch	24 inch	3.5 ft	4 ft	4 ft/6 ft	4 ft/6 ft
Antenna Type	Radome	Radome	Open	Open	Open	Open
Beam Width						
Horizontal	5.2°	3.9°	2.3°	1.9°	1.9°/1.4°	1.9°/1.4°
Vertical	25°	25°	22°	22°	22°/22°	22°/22°
Max. Range	24 nm	36 nm	48 nm	64 nm	72 nm	96 nm
48 rpm Capability	●	●	●	●	●	●

FURUNO CAN bus base network

The NavNet 3D radar sensor incorporates a CAN bus port to which FURUNO's CAN bus sensors such as the WS-200 Weather Station and the SC-30 Satellite Compass can be directly connected. Power for these networked CAN bus sensors is supplied from the CAN bus. This unique feature allows for flexible installation of multiple CAN bus sensors without the need to run cables all the way to the main processor unit. CAN bus data is converted and distributed throughout the NavNet 3D Ethernet network.

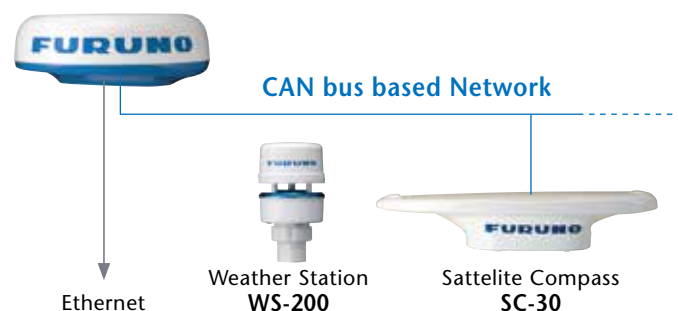

FISH FINDER



NavNet 3D Network Fish Finder

The FURUNO DFF1 and DFF3 can turn any NavNet 3D display into a powerful, dual frequency fish finder. They can be connected directly to a NavNet display or an Ethernet hub with a single Ethernet cable. DFF1 has 600 W or 1 kW output power, while DFF3 has 1/2/3 kW output power. Both supports a variety of transducer options.

- ▶ Enhanced detection of fish targets by FURUNO Digital Filter (FDF™) Fish Finder technology
- ▶ Selectable display modes include High or Low Frequency, Dual Frequency, Zoom, Nav Data, A-Scope, Marker Zoom, Bottom Zoom or Bottom-Lock
- ▶ Audio and visual alarms alert you whenever preset limits are met for water depth, water temperature and fish echoes
- ▶ Two selectable automatic gain control modes: Cruising and Fishing modes to match your boating purposes
- ▶ IP address is automatically assigned for Plug and Play installation

FURUNO Free Synthesizer (FFS) transceiver on the DFF3 allows you to choose any two frequencies from 28 to 200 kHz

FURUNO free Synthesizer (FFS), a mechanism used for the professional fish finder FCV-1200L, is utilized for the DFF3 transceiver. FFS allows you to operate a fish finder in any of the two operating frequencies from 28 to 200 kHz without using a matching box.

This mechanism gives you the freedom to choose your operating frequencies for more productive fishing. Output power of the DFF3 can also be selected among 1, 2 and 3 kW to suit a variety of situations.

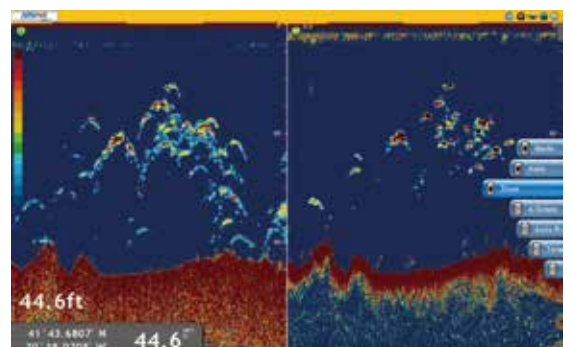
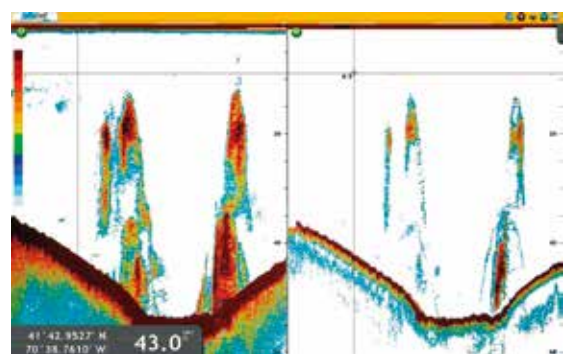



NavNet 3D Display Options

You can select from 8.4" or 12.1" Multi-Function Displays (MFDs) or go with a BlackBox option with custom monitors of screen resolution up to SXGA (1280 x 1024 pixels). You can freely configure your system from the available options to suit your boating style and navigational requirements. All of the NavNet 3D display options come with high brightness, sunlight-readable LCD enhanced by anti-reflective glass coating that allows operation even under the direct sunlight.

8.4" and 12.1" MFDs

Choose from 8.4" or 12.1" NavNet 3D MFDs. Its low profile design fits beautifully right into your helm console. Fog-free structural design has been applied to both the MFD8 and MFD12 so that the presentation will never be disturbed by water condensation, caused by an air gap between the LCD and the front coverplate.

MFD8



MFD12



BlackBox Configuration

The NavNet 3D BlackBox configuration is available for those who wish to choose their own display. You can select either FURUNO's lineup of 15", 19" Marine LCDs or other third party displays.

MU-150HD/MU-190HD Marine LCDs



MFDBB



Keyboard



Processor

Combine FURUNO's Marine LCD MU Series with MFDBB Processor and Keyboard to configure the NavNet 3D BlackBox system

Easy Flush Mount Installation

Flush mounting your display is now easier than ever. All NavNet 3D display options attach to the mounting console with bolts from the front side.



NavNet 3D Display Options

	MFD8	MFD12	MFDBB
Screen Size and Resolution	8.4" LCD VGA (640 x 480) Video Out Resolution: VGA	12.1" LCD SVGA (800 x 600) Video Out Resolution: SVGA	12.1" SVGA (800 x 600) 15" XGA (1024 x 768) 17" SXGA (1280 x 1024)
Brightness	700 cd	1100 cd	
NMEA0183 in/out	3 x in/out ports		
CAN bus/NMEA2000®	1 port		
Ethernet (100 BASE-TX)	1 port	4 port hub included	
USB	1 x USB 1.1	2 x USB 2.0	
Video IN (NTSC/PAL)	2 inputs	4 inputs	
SD Card Slot	2 slots	2 slots in a control unit	
Audio IN/OUT	1 output		

Changing your display presentation is easier than ever before!

NavNet 3D allows you to customize your display from a single screen presentation up to a four-way-split arrangement. NavNet 3D comes standard with five display hot-pages to select, with the ability to increase your options to ten hot-pages. Rearrange the display configuration to suit your style by combination of the DISP key and RotoKey™. You can freely configure the display so that you will have the information you want right where you want it!

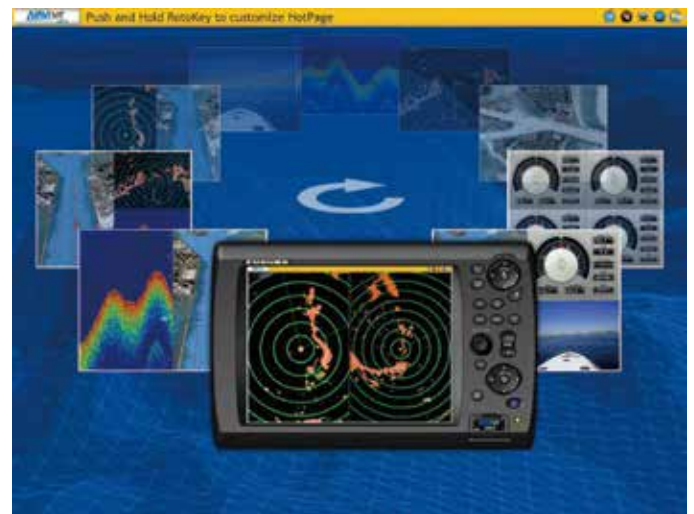

Single Screen Display

In the single screen display mode, you can place the presentation of chart plotter, radar, fish finder and external video camera.



Split-Screen Display

NavNet 3D allows you to split the screen in up to four separate segments. In each segment, you can assign the following information.

- 1 In the half-way split screen, you can place the chart plotter, radar, fish finder and external video camera.
- 2 In the quarter-split-screen, you can place the presentation of chart plotter, radar, fish finder, external video camera and navigation instruments.



Chart plotter



Radar



External video camera



Fish finder



Navigation instrument

Status Bar and Status Icons

The status bar at the top of the display provides you with operating information with text messages and sensor status icons.

Default



Bar color turn to red

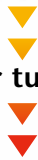

Emergency



Sensor Status Icons

The Sensor Status Icons show whether the sensors are active or inactive. The sensor icons are animated when active, and a red "X" is placed over the icons when the sensor is inactive.



	Sensor working in order	Sensor inactive
Multimedia		
Weather		
Compass		
GPS		
Fish Finder		
Radar		

Text Message

Text messages include operational guide and alarm messages. When set alarm criteria are met or violated, the status bar turns red and the warning status message is shown in the status bar.



IP Camera & External Video Camera Displays

NavNet 3D displays video input from onboard IP cameras and analog video cameras, allowing you to monitor the engine room and surroundings while navigating from the helm or keeping an eye on blind spots while docking. The MFD8 and MFD12 incorporates two video input ports, while the MFD8B has four video input ports, supporting multiple video sources to be displayed at the same time for enhanced navigation monitoring. Up to four IP cameras can be connected to the network. Pan, tilt and zoom features can be controlled from the NavNet 3D scrolling pad when utilizing Axis IP cameras with these capabilities.

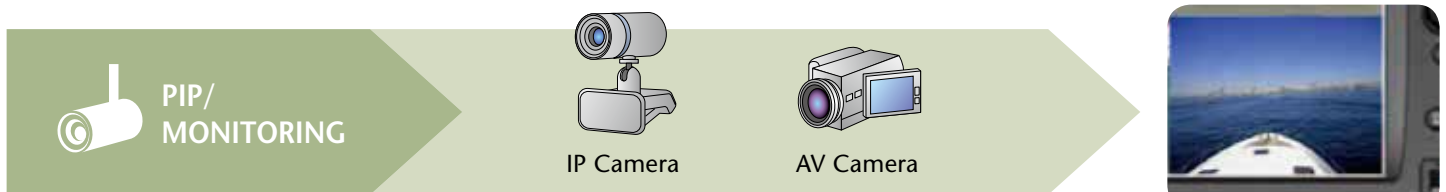

Onboard Monitoring



Engine Room Monitoring



SYSTEM EXPANDABILITY



Enhanced Monitoring of Surrounding Areas

Once interfaced with the Satellite Compass and AIS receiver/transponder, NavNet 3D enables enhanced monitoring of vessel traffic around your craft for a safer boating experience.

Enhanced Radar/Chart Overlay, ARPA Target Tracking and Echo Trail

When interfaced with the highly accurate heading data from the SC-30/50/110 Satellite Compass, NavNet 3D Radar/Chart overlay, ARPA Target Tracking and Echo Trail functions can be greatly enhanced.

Even when performing quick turning maneuvers or running into rough seas, NavNet 3D with the SC-30/50/110 presents clear and stable radar echo trails, constant ARPA tracking and spot-on Radar/Chart Plotter Overlay.



Radar-Chart overlay

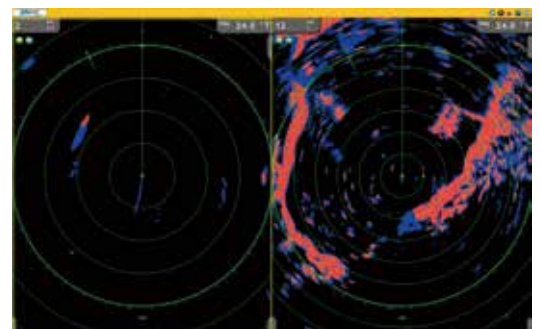

Radar echo trail

AIS Target Tracking

When the FURUNO AIS FA-30/50/150 is interfaced with NavNet 3D, the AIS information is integrated into the NavNet 3D network to facilitate enhanced monitoring of the surrounding area from any station. Up to 100 AIS targets can be tracked and displayed with five different symbols to indicate their status. Detailed information about a specific target can be viewed in a pop-up AIS data window.

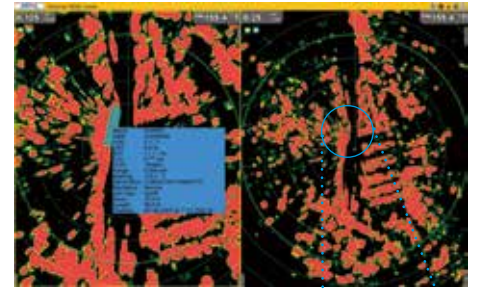

What is AIS?

The Automatic Identification System (AIS) improves the safety level of boating by exchanging information about the status of own ship with other nearby AIS-equipped craft. The system utilizes VHF broadcasts to share information about the surrounding area, such as other craft and buoys and other aids to navigation.

AIS data includes position, course and speed over ground, allowing you to foresee the course changes of specific targets. AIS targets are constantly visible even when they are shrouded in fog or darkness, or hidden behind capes, river bends and other obstructions.

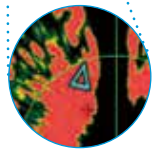
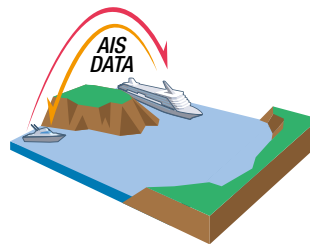

Information to be Exchanged

Dynamic Data

- ▶ Ship's Position
- ▶ Coordinated Universal Time (UTC)
- ▶ Course over Ground (COG)
- ▶ Speed over Ground (SOG)
- ▶ Rate of Turn (ROT)
- ▶ Heading
- ▶ Navigation Status

Static Data

- ▶ MMSI (Maritime Mobile Service Identity)
- ▶ IMO Number

- ▶ Ship's Name
- ▶ Type of Ship
- ▶ Call Sign
- ▶ Length and Beam
- ▶ Location of Position-Fixing Antenna on the Ship

Voyage-Related Data

- ▶ Ship's Draft
- ▶ Hazardous Cargo
- ▶ Destination and Estimated Time of Arrival (ETA)

Safety-Related Messages



Heaving Compensation with Satellite Compass SC-30/50/110

An unstable fish finder presentation caused by vessel's heaving motion will no longer be an issue. FURUNO's Satellite Compass SC-30, SC-50 and SC-110 detect your vessel's heaving motion and transfer the data to the networked fish finder. It then corrects the echo distortion and delivers stable underwater presentation to your network.



Heaving compensation ON

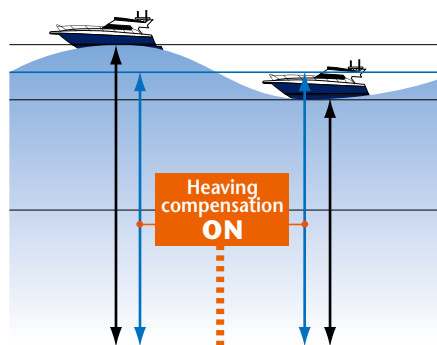

Heaving compensation OFF

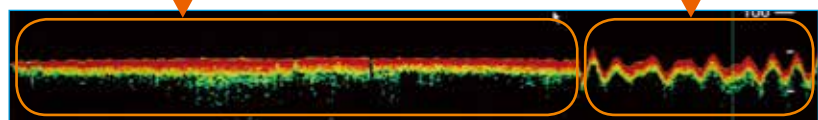
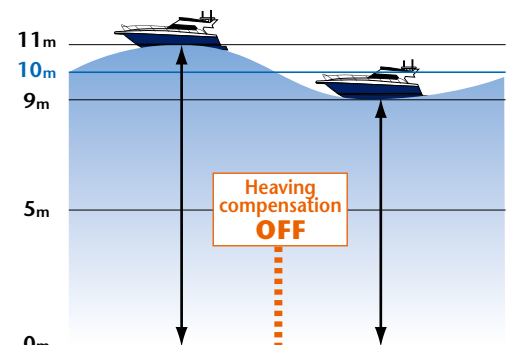

Weather Data Integration Sirius Satellite Marine Weather

Keeping track of weather is easier than ever with FURUNO's Sirius Satellite Weather Receiver BBWX1 for NavNet 3D. FURUNO and Sirius have teamed up to bring you live, up-to-the-minute weather information and forecasting to give you peace of mind, no matter when or how you are boating. The weather information is obtained from the weather industry's leading experts and is delivered via digital receiver through Sirius Marine Weather services.

You have the ability to receive high-quality and comprehensive weather information and forecasting that you can overlay with your NavNet 3D charts. You will be provided with premium weather contents, such as current weather reports, NOWRad® nationwide high resolution weather radar imagery and Sea Surface Temperature images that can help fishermen locate hot spots.

Available only in the U.S., Sirius Marine Weather service coverage includes the 48 contiguous states, most of Canada, Mexico, and waters extending hundreds of miles into the Atlantic and Pacific oceans, the Gulf of Mexico, and Caribbean. A monthly Sirius Marine Weather subscription (sold separately) is required. An added benefit is the ability to now control Sirius Radio audio on NavNet 3D when connected to an external speaker.

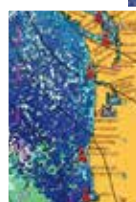

Sea Surface Temperature

Visual reading on varying surface water temperature can be acquired: with red showing the warmest and blue showing the coolest areas.

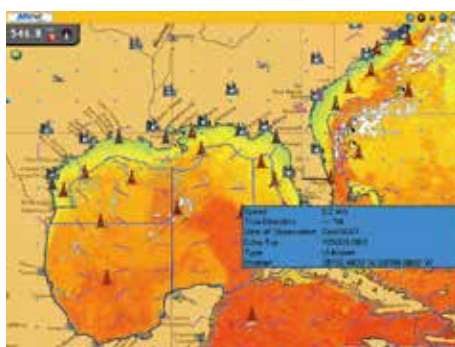

FAX-30

Turn your NavNet 3D display into Weather fax/NAVTEX receiver by connecting the FAX-30 Weather Receiver.

- ▶ Up to 12 satellite photos can be stored in memory
- ▶ Programmed with all currently available facsimile stations: up to 320 channels available
- ▶ Presentation in monotone, 16-gradation gray scale or color (three patterns of color presentation are available)
- ▶ Built-in NAVTEX receiver (490 kHz and 518 kHz) can store up to 130 messages



WWW.NAVNET.COM



Whenever you require any information about NavNet 3D, just visit our web site, solely dedicated to the current and would-be users of NavNet 3D, www.NavNet.com. At NavNet.com, you can access the contents with in-depth product information from various angles, including a NavNet 3D demonstration film, introduction to the product, product specifications, online tutorial, training video, system suggestions and user interviews and much more! Also, you can find answers to questions you may have in our solution database (FAQs) on the web site.



Your benefits from "My NavNet" through NavNet 3D online user-registration

For your convenience, you can register your NavNet 3D products online at NavNet.com. When you register online, you will automatically gain access to your "My NavNet" page where you will gain access to various premium benefits, including: online software updates, online chart update and personalized news services. The site is updated constantly to deliver the most up-to-date information about the product.





SPECIFICATIONS

Multi Function Display	MFD8 MFD12 MFD8B
Network Fish Finder	DFF1 DFF3
GPS/WAAS Receiver Antenna	BBWGPS GP-330B
Network Weather Facsimile Receiver	FAX-30
Network Satellite Weather Receiver	BBWX1
LCD Display	MU-150HD MU-190HD
NavNet 3D Radar Sensor	DRS2D DRS4D DRS4A DRS6A DRS12A DRS25A



Multi Function Display		MFD8	MFD12
DISPLAY UNIT			
Type		8.4" Color TFT LCD	12.1" Color TFT LCD
Screen Size		8.4", 170.4 x 127.8 mm	12.1", 246.0 x 184.5 mm
Screen Resolution		VGA 640 x 480 pixels	SVGA 800 x 600 pixels
Screen Brightness		700 cd (typical)	1100 cd (typical)
Display Colors		Chart Plotter/Menu: 65,536 colors Fish Finder: 64 colors Radar: 32 Colors	
Language		English (US & UK), French, Spanish, German, Italian, Portuguese, Swedish, Danish, Norwegian, Finnish, Dutch, Japanese	
PLOTTER CHARACTERISTICS			
Memory Capacity		Up to 10,000 points for ship's tracks, 2000 user points, 200 planned routes (100 points per route)	
Display Modes		Course plot, NAV data, Navigational instrument display, Engine monitoring display	
Latitude Limit		Between 85°N and 85°S	
Alarms		Anchor Watch, XTE, Proximity, Depth, Temperature, Speed, Trip Log, Countdown, Timer, Alarm Clock	
RADAR CHARACTERISTICS			
Display Modes		Head-up, Course-up*, North-up*, Relative Motion, True Motion** (*Heading input required **Heading and speed inputs required)	
Echo Trail		Interval: 15 s, 30 s, 1 min, 3 mins, 6 mins, 15 mins, 30 mins and continuous	
INTERFACE			
LAN		1 Port, 100 BASE-TX	
NMEA0183		3 Ports for Input/Output	
Interface (NMEA0183)	Input:	DBK, DBS, DBT, DPT, DTM, GGA, GLL, GNS, HDG, HDM, HDT, MDA, MTW, MWV, RMA, RMC, ROT, VDM, VHW, VTG, VWR, VWT, ZDA, FURUNO Proprietary Sentences are used for pitch, roll and heave data input from FURUNO Satellite Compass SC series.	
	Output:	AAM, APB, BOD, BWC, BWR, DBT, DPT, DTM, GGA, GLL, GNS, GTD, HDG, HDT, MTW, MWV, RMA, RMB, RMC, ROT, VHW, VTG, WPL, XTE, ZDA, ZTG, FURUNO Proprietary Sentence is used for true heading, pitch and roll data output.	
CAN bus/NMEA2000®		1 Port	
Interface (CAN bus/NMEA2000®)	Input:	059392, 059904, 060928, 126208, 126992, 126996, 127245, 127250, 127251, 127257, 127258, 127488, 127489, 128259, 128267, 129025, 129026, 129029, 129033, 129044, 129538, 129540, 129808, 130306, 130310, 130311, 130577	
	Output:	059392, 059904, 060928, 126208, 126464, 126992, 126996, 127245, 127250, 127251, 127257, 127258, 128275, 128259, 128267, 129025, 129026, 129029, 129033, 129283, 129284, 130306, 130310, 130311	
USB Port		1 Port (USB 1.1)	
Video Output		1 Port (DVI-D VGA)	1 Port (DVI-D SVGA)
Video Input		2 Ports (NTSC/PAL)	
Line Out		1 Port	
SD Card Slot		2 Slots	
Variable Line Level Stereo Output		N/A	
ENVIRONMENT			
Temperature (IEC60945)	Display Unit	-15°C to +55°C	
	Processor Unit		
	Control Unit		
Waterproofing	Display Unit	IP56 (IEC60529)	
	Processor Unit		
	Control Unit		
POWER SUPPLY			
		12-24 VDC	
		29 W/73 W (with DRS2D)/77 W (DRS4D)/104 W (with DRS4A)/131 W (with DRS6A)/143 W (with DRS12A)/174 W (with DRS25A)	41 W/86 W (with DRS2D)/91 W (DRS4D)/132 W (with DRS4A)/144 W (with DRS6A)/159 W (with DRS12A)/186 W (with DRS25A)
		100/110/220/230 VAC with optional rectifier RU-1746B-2/PR-62/RU-3423	

* With regard to the NMEA 2000 PGN specifications, please refer to P.37.

Multi Function Display (Table-top Mount) MFD8

4.7 kg 10.4 lb

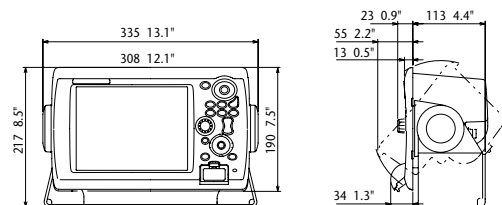

Multi Function Display (Flush Mount) MFD8

3.9 kg 8.6 lb

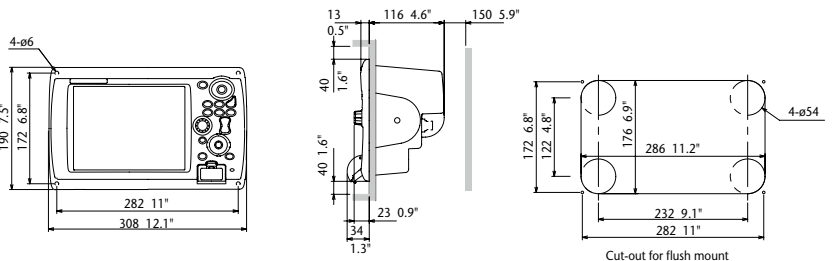

Multi Function Display (Table-top Mount) MFD12

6.8 kg 15.0 lb

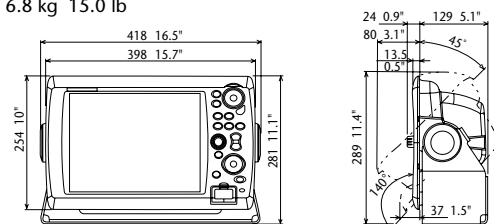

Multi Function Display (Flush Mount) MFD12

5.4 kg 11.9 lb

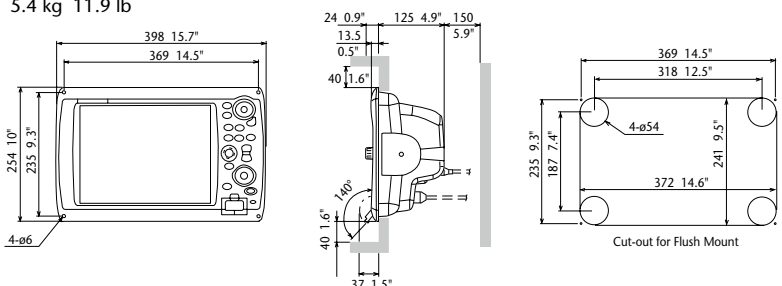



Multi Function Display		MFDBB
DISPLAY UNIT		
Type	Custom monitor of your choice	
Screen Size	Please refer to the specifications of MU-120C/155C/170C	
Screen Resolution	SVGA 800 x 600 pixels, XGA 1024 x 768 pixels or SXGA 1280 x 1024 pixels	
Screen Brightness	Please refer to the specifications of MU-120C/155C/170C	
Display Colors	Chart Plotter/Menu: 262,144 colors Fish Finder: 64 colors Radar: 256 colors	
Language	English (US & UK), French, Spanish, German, Italian, Portuguese, Swedish, Danish, Norwegian, Finnish, Dutch, Japanese	
PLOTTER CHARACTERISTICS		
Memory Capacity	Up to 10,000 points for ship's tracks, 2000 user points, 200 planned routes (100 points per route)	
Display Modes	Course plot, NAV data, Navigational instrument display, Engine monitoring display	
Latitude Limit	Between 85°N and 85°S	
Alarms	Anchor Watch, XTE, Proximity, Depth, Temperature, Speed, Trip Log, Countdown, Timer, Alarm Clock	
RADAR CHARACTERISTICS		
Display Modes	Head-up, Course-up*, North-up*, Relative Motion, True Motion** (*Heading input required **Heading and speed inputs required)	
Echo Trail	Interval: 15 s, 30 s, 1 min, 3 mins, 6 mins, 15 mins, 30 mins and continuous	
INTERFACE		
LAN	4-Port Hub is included, 100 BASE-TX	
NMEA0183	3 Ports for Input/Output	
Interface (NMEA0183)	Input:	DBK, DBS, DBT, DPT, DTM, GGA, GLL, GNS, HDG, HDM, HDT, MDA, MTW, MWV, RMA, RMC, ROT, VDM, VHW, VTC, VWR, VWT, ZDA, FURUNO Proprietary Sentences are used for pitch, roll and heave data input from FURUNO Satellite Compass SC series.
	Output:	AAM, APB, BOD, BWC, BWR, DBT, DPT, DTM, GGA, GLL, GNS, GTD, HDG, HDT, MTW, MWV, RMA, RMB, RMC, ROT, VHW, VTC, WPL, XTE, ZDA, ZTG, FURUNO Proprietary Sentence is used for true heading, pitch and roll data output.
CAN bus/NMEA2000®	1 Port	
Interface (CAN bus/NMEA2000®*)	Input:	059392, 059904, 060928, 126208, 126992, 126996, 127245, 127250, 127251, 127257, 127258, 127488, 127489, 128259, 128267, 129025, 129026, 129029, 129033, 129044, 129538, 129540, 129808, 130306, 130310, 130311, 130577
	Output:	059392, 059904, 060928, 126208, 126464, 126992, 126996, 127245, 127250, 127251, 127257, 127258, 128275, 128259, 128267, 129025, 129026, 129029, 129033, 129283, 129284, 130306, 130310, 130311
USB Port	2 Ports (USB 2.0)	
Video Output	2 Ports (DVI-D)	
Video Input	4 Ports (NTSC/PAL)	
Line Out	1 Port	
SD Card Slot	2 Slots	
Variable Line Level Stereo Output	1 Port	
ENVIRONMENT		
Temperature (IEC60945)	Display Unit	-15°C to +55°C (DCU12)
	Processor Unit	0°C to +45°C
	Control Unit	-15°C to +55°C
Waterproofing	Display Unit	IP56 (DCU12 when flush mounted) IEC60529
	Processor Unit	IP20
	Control Unit	IP56 (MCU-001 when flush mounted) IEC60529
POWER SUPPLY		
12-24 VDC		
104 W/149 W (with DRS2D)/154 W (DRS4D)/195 W (with DRS4A)/		
207 W (with DRS6A)/222 W (with DRS12A)/249 W (with DRS25A)		
100/110/220/230 VAC with optional rectifier RU-1746B-2		

* With regard to the NMEA 2000 PGN specifications, please refer to P.37.

Multi Function Display MFDBB BlackBox Processor Unit MPU-001

15.0 kg 33.1 lb

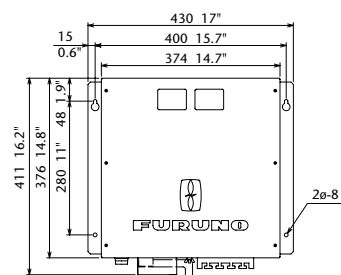

BlackBox Control Unit MCU-001

1.0 kg 2.2 lb

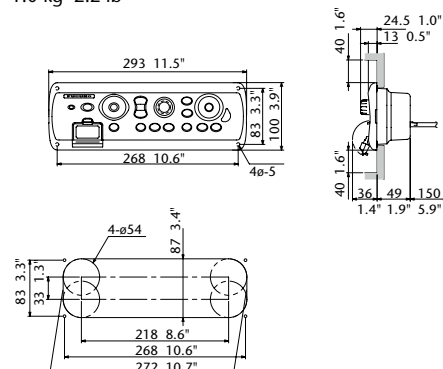



Network Fish Finder		DFF1	DFF3
TRANSCEIVER & DISPLAY			
Display Modes	Single (50 or 200 kHz), Dual (50 and 200 kHz), Bottom-lock, Bottom-Zoom, Bottom Discrimination, Marker Zoom, A-Scope	Single (High or Low frequency), Dual (Both High and Low frequencies), Bottom-lock, Bottom-Zoom, Bottom Discrimination, Marker Zoom, A-Scope	The synthesized transducer works with dual frequencies between 28 and 200 kHz
Frequency	Dual frequency 50 kHz and 200 kHz		
Output Power	600 W/1 kW		1, 2 or 3 kW
Range Scale	Any range customized between 2 and 1,200 m		
Range Phasing	Up to 2,400 m (8,000 ft, 1,300 fa)		Up to 2,400 m (8,000 ft, 1,300 fa)
ENVIRONMENT			
Temperature	-15°C to +55°C		
Water Proofing	IEC 60529 IP20		
POWER SUPPLY			
	12 W	12-24 VDC	30 W
TRANSDUCERS (Specify when ordering)			
	600 W 50/200 kHz: 520-5PSD (Plastic, thru-hull), 520-5MSD (Bronze, thru-hull), 520-5PWD (Plastic, transom), 525ST-MSD (Bronze, thru-hull with speed/temp sensor), 525ST-PWD (Plastic, transom, with speed/temp sensor) 1kW (Optional Matching box, MB-1100 may be required) 50 kHz: 50B-6, 50B-6B, 50B-9B 200 kHz: 200B-5S, 50/200 kHz: 50/200-1T, 50/200-12M	28 kHz 38 kHz 50 kHz 68 kHz 82 kHz 88 kHz 107 kHz 150 kHz 200 kHz 50/200 kHz	28F-8, 28F-18, 28BL-6HR, 28F-24H, 28BL-12HR 38BL-9HR, 38BL-15HR 50B-6/6B, 50B-9B, 50B-12, 50BL-12HR, 50F-24H, 50BL-24HR 68F-8H, 68F-30H 82B-35R 88B-8, 88B-10, 88F-126H 100B-10R 150B-12H 200B-5S, 200B-8/8B, 200B-12H 50/200-1ST, 50/200-1T, 50/200-12M



(for the US market only)

GPS/WAAS Receiver Antenna		
	BBWGPS	GP-330B
RECEIVER CHARACTERISTICS		
Receiver Type	Twelve discrete channels, C/A code, all-in-view, WAAS	
Receiving Frequency	L1 (1575.42 MHz)	
Time to First Fix	12 s (warm start)	90 s (cold start)
Tracking Velocity	999 kt	
Geodetic Systems	WGS-84, NAD-27 and others	
Accuracy	10 m (GPS) 3 m (WAAS)	
ENVIRONMENT (IEC 60945 test method)		
Temperature	-25°C to +70°C	-25°C to +55°C
Waterproofing	IEC 60529 IPX6	IEC 60529 IP56
POWER SUPPLY		
	12-24 VDC	12 VDC
	1.3 W	1.8 W

Network Weather Facsimile Receiver	
	FAX-30
TRANSCEIVER CHARACTERISTICS	
Frequency Range	80 kHz to 160 kHz, 2 MHz to 25 MHz, 490 kHz, 518 kHz (NAVTEX)
Class of Emmission	F3C, J3C, F1B (NAVTEX)
Receiving System	Double superheterodyne
Storage	Fax: 12 pictures NAVTEX: 130 messages
ENVIRONMENT (IEC 60945 test method)	
Temperature	-15°C to +55°C
Waterproofing	IEC 60529 IPX2
POWER SUPPLY	
	12-24 VDC
	12 W

Network Satellite Weather Receiver	
	BBWX1
TRANSCEIVER CHARACTERISTICS	
Receiver Type	Sirius Satellite Radio Weather Receiver
Mounting	Bulkhead
Interface	Ethernet
ENVIRONMENT	
Temperature	0°C to +55°C (Operating) -35°C to +85°C (Storage)
Waterproofing	IEC 60529 IPX5
POWER SUPPLY	
	12-24 VDC
	10 W

Network Fish Finder DFF1

1.3 kg 2.9 lb

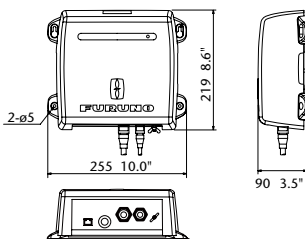

Network Fish Finder DFF3

3.8 kg 8.4 lb

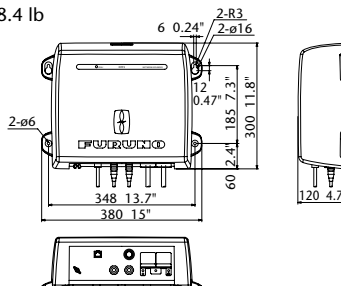

GPS/WAAS Receiver Antenna BBWGPS

0.8 kg 1.8 lb

10 m cable attached

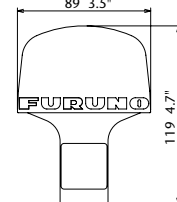

GPS/WAAS Receiver Antenna GP-330B

0.22 kg 0.49 lb

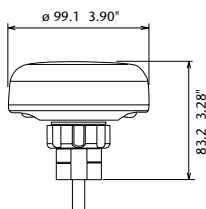

Network Weather Facsimile Receiver FAX-30

2.0 kg 4.4 lb

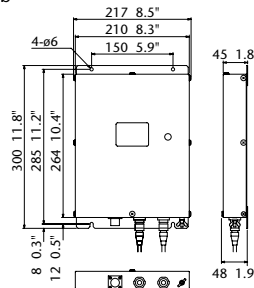

Network Satellite Weather Receiver BBWX1

1.9 kg 4.2 lb

(for the US market only)

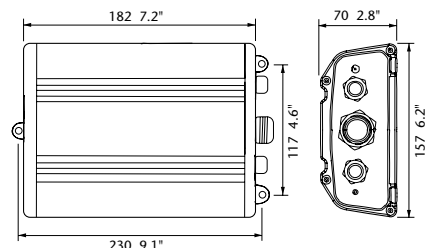



LCD Display DISPLAY UNIT		MU-150HD	MU-190HD
Screen Size		15 inches, 304.1 x 228.1 mm	17 inches, 338.0 x 270.0 mm
Resolution		XGA 1024 x 768 pixels	SXGA 1280 x 1024 pixels
Contrast Ratio		600: 1	900: 1
Viewing Angle	Vertical	up 80° to down 80° or more left 80° to right 80° or more	
	Horizontal		
Brightness		Max. 1000 cd/m ² , Min. 0.2 cd/m ² or under	
INTERFACE			
Analog RGB		1 port, D-SUB/15 pins	
DVI		2 ports, DVI-D	
Composite (RCA) input		3 ports, NTSC/PAL	
ENVIRONMENT (IEC 60945 test method)			
Temperature		-15°C to +55°C	
Waterproofing		IP56 (CFR46 Front Panel), IP22 (Back Panel)	
POWER SUPPLY			
		12-24 VDC, 4.5 - 2.2 A	12-24 VDC, 8.4 - 3.9 A

MU-150HD Table-top Mount (option)

7.4 kg 16.3 lb

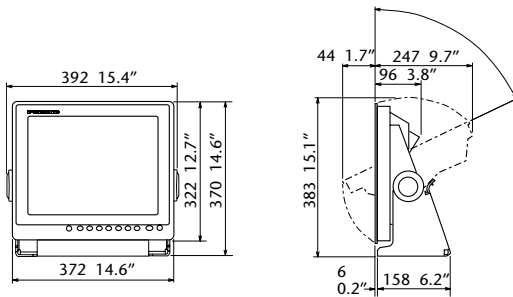

MU-150HD Flush Mount

5.4 kg 11.9 lb

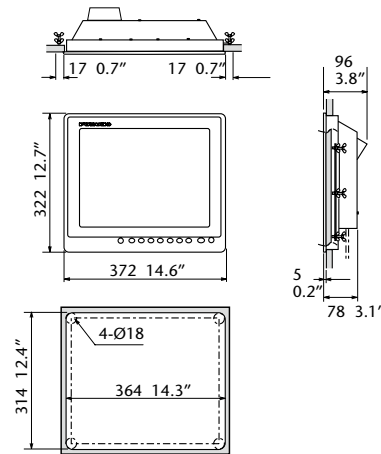

MU-190HD Table-top Mount (option)

11 kg 24.3 lb

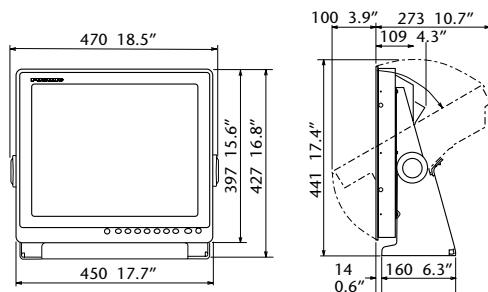

MU-190HD Flush Mount

8.2 kg 18.1 lb

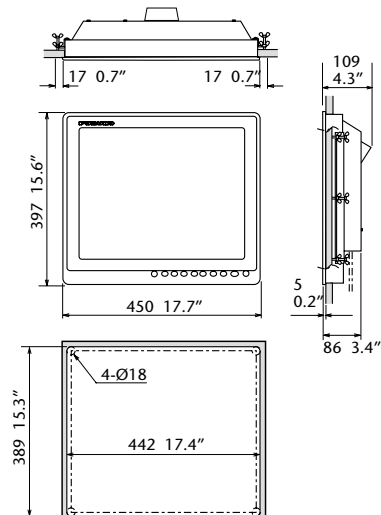



NavNet 3D Radar Sensor		DRS2D	DRS4D	DRS4A
ANTENNA				
Peak Output Power		2.2 kW	4 kW	4 kW
Type		19" Radome	24" Radome	3.5' Open
RF TRANSCEIVER				
Frequency		9410 ± 30 MHz		
Pulselength & PRR		0.08 μs/3000 Hz (0.0625 to 0.75 nm) 0.15 μs/3000 Hz (1 to 1.5 nm) 0.3 μs/1500 Hz (2 nm) 0.5 μs/1000 Hz (3 to 4 nm) 0.7 μs/600 Hz (6 to 8 nm) 0.8 μs/600 Hz (12 to 24 nm)	0.08 μs/3000 Hz (0.0625 to 0.75 nm) 0.15 μs/3000 Hz (1 to 1.5 nm) 0.3 μs/1500 Hz (2 nm) 0.5 μs/1000 Hz (3 to 4 nm) 0.7 μs/600 Hz (6 to 8 nm) 0.8 μs/600 Hz (12 to 36 nm)	0.08 μs/3000 Hz (0.0625 to 0.75 nm) 0.15 μs/3000 Hz (1 to 1.5 nm) 0.3 μs/1500 Hz (2 nm) 0.5 μs/1000 Hz (3 to 4 nm) 0.7 μs/600 Hz (6 to 8 nm) 0.8 μs/600 Hz (12 to 48 nm)
Beam Width	Horizontal	5.2°	4.0°	2.3°
	Vertical	25°	25°	22°
Range Scales		0.0625 to 24 nm	0.0625 to 36 nm	0.0625 to 48 nm
Antenna Rotation Speed		24/36/48 rpm		
Wind Load		Relative Wind 70 kt		
ENVIRONMENT				
Temperature		-30°C to + 55°C		
Waterproofing		IP26		
Power Amp Unit	MFD8	Not required (Power Provided by the Display Unit)		PSU-012 (75 W)
	MFD12	Not required (Power Provided by the Display Unit)		
	MFD8B	Not Required (Power Provided by the BB Processor)		

19" Radome Radar Sensor DRS2D

6.5 kg 14.3 lb

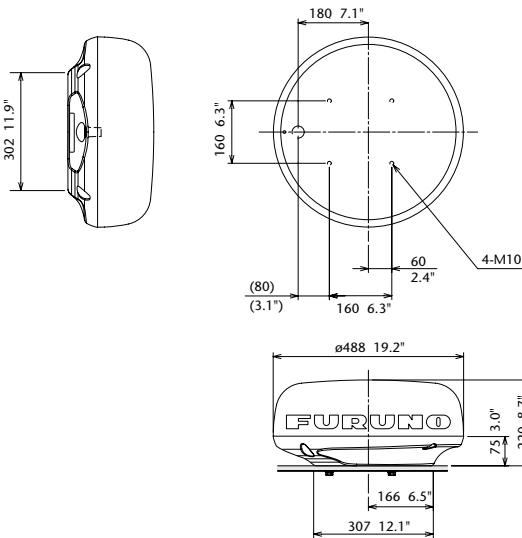

3.5' Open Radar Sensor DRS4A

25 kg 55.1 lb

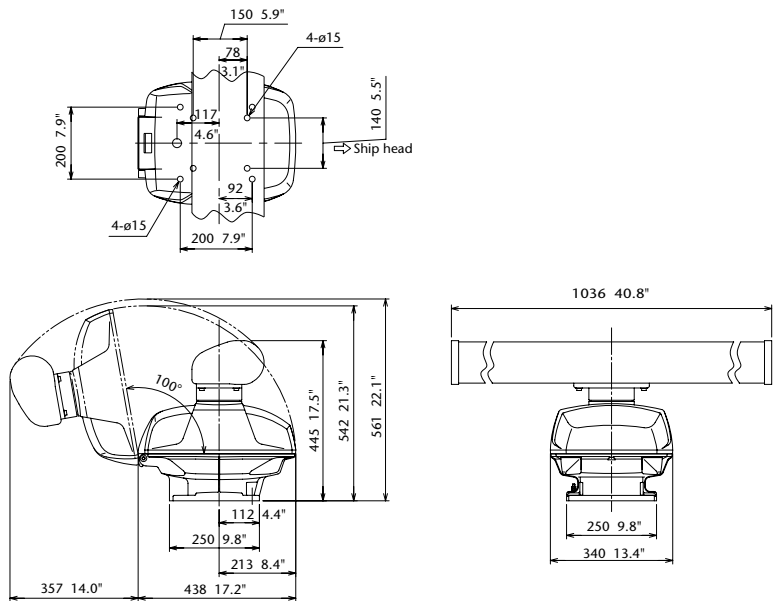

24" Radome Radar Sensor DRS4D

7.5 kg 16.5 lb

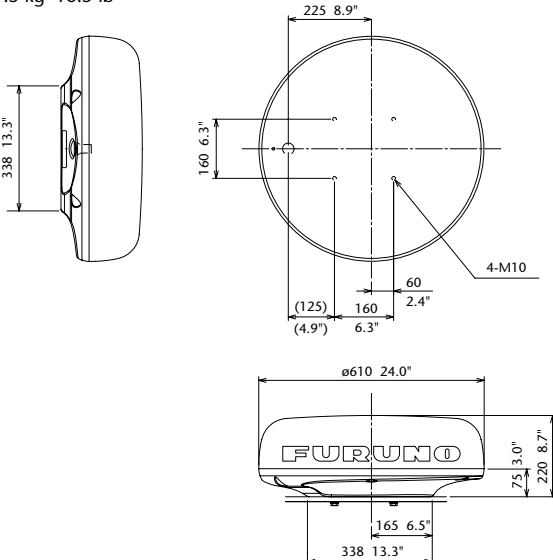



NavNet 3D Radar Sensor		DRS6A	DRS12A	DRS25A
ANTENNA				
Peak Output Power		6 kW	12 kW	25 kW
Type		4' Open	4'/6' Open	4'/6' Open
RF TRANSCEIVER				
Frequency		9410 ± 30 MHz		
Pulselength & PRR		0.08 μs/3000 Hz (0.0625 to 0.75 nm) 0.15 μs/3000 Hz (1 to 1.5 nm) 0.3 μs/1500 Hz (2 nm) 0.5 μs/1000 Hz (3 to 4 nm) 0.7 μs/600 Hz (6 to 8 nm) 0.8 μs/600 Hz (12 to 64 nm)	0.08 μs/3000 Hz (0.0625 to 0.75 nm) 0.15 μs/3000 Hz (1 to 1.5 nm) 0.3 μs/1500 Hz (2 nm) 0.5 μs/1000 Hz (3 to 4 nm) 0.7 μs/600 Hz (6 to 8 nm) 0.8 μs/600 Hz (12 to 64 nm) 0.8 μs/550 Hz (72 nm)	0.08 μs/3000 Hz (0.0625 to 0.75 nm) 0.15 μs/3000 Hz (1 to 1.5 nm) 0.3 μs/1500 Hz (2 nm) 0.5 μs/1000 Hz (3 to 4 nm) 0.7 μs/600 Hz (6 to 8 nm) 0.8 μs/600 Hz (12 to 64 nm) 0.8 μs/550 Hz (72 to 96 nm)
Beam Width	Horizontal	1.9°	1.9°/1.4°	1.9°/1.4°
	Vertical	22°	22°/22°	22°/22°
Range Scales		0.0625 to 64 nm	0.0625 to 72 nm	0.0625 to 96 nm
Antenna Rotation Speed		24/36/48 rpm		
Wind Load		Relative Wind 70 kt		
ENVIRONMENT				
Temperature		-30°C to + 55°C		
Waterproofing		IP26		
Power Amp Unit	MFD8	PSU-012 (102 W)	PSU-012 (118 W)	PSU-013 (145 W)
	MFD12	Not required (Power Provided by the Display Unit)	PSU-012 (118 W)	PSU-013 (145 W)
	MFD8B	Not Required (Power Provided by the BB Processor)		PSU-013 (145 W)

4' Open Radar Sensor DRS6A/12A/25A

25 kg 55.1 lb

6' Open Radar Sensor DRS12A

26 kg 57.3 lb

6' Open Radar Sensor DRS25A

28 kg 61.7 lb

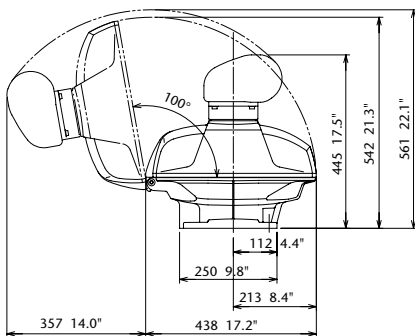
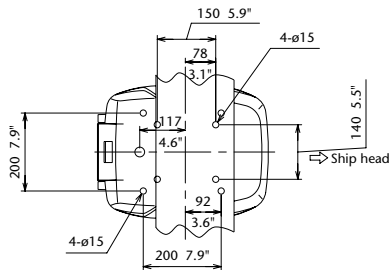

DRS6A/12A/25A (XN12A): 1255 49.4"
DRS12A/25A (XN13A): 1795 70.7"

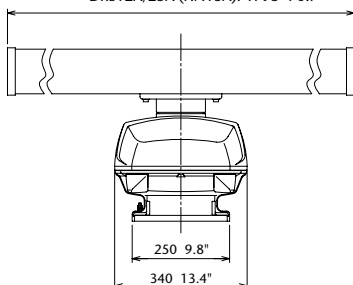

NMEA 2000 Input

PGN	Details
059392	ISO Acknowledgement
059904	ISO Request
060928	ISO Address Claim
126208	NMEA - Request group function NMEA - Command group function NMEA - Acknowledge group function
126992	System Time
126996	Product Information
127245	Rudder
127250	Vessel Heading
127251	Rate of Turn
127257	Attitude
127258	Magnetic Variation
127488	Engine parameters, Rapid Update
127489	Engine Parameters, Dynamic
128259	Speed
128267	Water Depth
129025	Position, Rapid Update
129026	COG & SOG, Rapid Update
129029	GNSS Position Data
129033	Time & Date
129044	Datum
129538	GNSS Control Status
129540	GNSS Satellites in View
129808	DSC Call Information
130306	Wind Data
130310	Environmental Parameters
130311	Environmental Parameters
130577	Direction Data

Output

PGN	Details
059392	ISO Acknowledgement
059904	ISO Request
060928	ISO Address Claim
126208	NMEA - Request group function NMEA - Command group function NMEA - Acknowledge group function
126464	PGN List
126992	System Time
126996	Product Information
127245	Rudder
127250	Vessel Heading
127251	Rate of Turn
127257	Attitude
127258	Magnetic Variation
128275	Distance Log
128259	Speed
128267	Water Depth
129025	Position, Rapid Update
129026	COG & SOG, Rapid Update
129029	GNSS Position Data
129033	Time & Date
129283	Cross Track Error
129284	Navigation Data
130306	Wind Data
130310	Environmental Parameters
130311	Environmental Parameters

NOTE



www.furuno.com

All brand and product names are registered trademarks,
trademarks or service marks of their respective holders.
Alpha blending technology is used for transparency effects.
SPECIFICATIONS SUBJECT TO CHANGE WITHOUT NOTICE

FURUNO ELECTRIC CO., LTD.
Nishinomiya, Hyogo, Japan
www.furuno.com

FURUNO U.S.A., INC.
Camas, Washington, U.S.A.
www.furunousa.com

FURUNO (UK) LIMITED
Havant, Hampshire, U.K.
www.furuno.co.uk

FURUNO FRANCE S.A.S.
Bordeaux-Mérignac, France
www.furuno.fr

FURUNO ITALIA S.R.L.
Gatteo Mare, Italy
www.furuno.it

FURUNO ESPAÑA S.A.
Madrid, Spain
www.furuno.es

FURUNO DANMARK A/S
Hvidovre, Denmark
www.furuno.dk

FURUNO NORGE A/S
Ålesund, Norway
www.furuno.no

FURUNO SVERIGE AB
Västra Frölunda, Sweden
www.furuno.se

FURUNO FINLAND OY
Espoo, Finland
www.furuno.fi

FURUNO POLSKA Sp. z o.o.
Gdynia, Poland
www.furuno.pl

FURUNO EURUS LLC
St. Petersburg, Russian Federation
www.furuno.ru

FURUNO SINGAPORE PTE LTD
Singapore
www.furuno.sg

FURUNO DEUTSCHLAND GmbH
Rellingen, Germany
www.furuno.de

FURUNO HELLAS S.A.
Piraeus, Greece
www.furuno.gr

FURUNO (CYPRUS) LTD
Limassol, Cyprus
www.furuno.com.cy

FURUNO CHINA CO., LTD.
Shanghai, China
www.furuno.com/cn

FURUNO SHANGHAI CO., LTD.
Shanghai, China
www.furuno.com/cn