

FURUNO

FULL-CIRCLE COLOR SCANNING SONAR

Model

CSH-5L MARK-2

- ▶ Full-circle scanning sonar detects and instantaneously displays fish schools and underwater conditions
- ▶ Vivid 16-color display assists in recognition of bottom structure, concentration and distribution of fish schools
- ▶ Various fishing and navigation data* keeps operator abreast of fishing and navigation conditions
*Requires appropriate sensors
- ▶ Four user-programmable function keys for quick set up according to fishing conditions or specific functions
- ▶ High power transmitter ensures reliable operation under any conditions
- ▶ Transducer frequency: 55 or 68 kHz



Photo: Control unit with optional monitor MU-150HD

www.furuno.com

High power transmitter for long range fish detection and determining changing seabed conditions

The CSH-5L MARK-2 is the full-circle scanning sonar that rapidly detects and displays individual fish, schools of fish and changing underwater conditions. Fish distribution and seabed conditions are shown in 16 colors, 360 degrees around your vessel.

The CSH-5L MARK-2 is a middle frequency sonar (55/68 kHz), which makes it ideal for searching for distant fish schools all around vessel. With automatic tilt scanning as a standard feature, the CSH-5L MARK-2 is suitable for both midwater trawlers and purse seiners.

The CSH-5L MARK-2 is provided in a BlackBox configuration for space saving and flexible installation. It consists of a compact hull unit, transceiver unit and processor unit. A variety of monitors are available to suit your installation and operational requirements. FURUNO's MU-series displays are specially designed to meet the requirements of marine professionals around the world. For a remote station, a second display and remote control can be simply plugged into the processor unit.

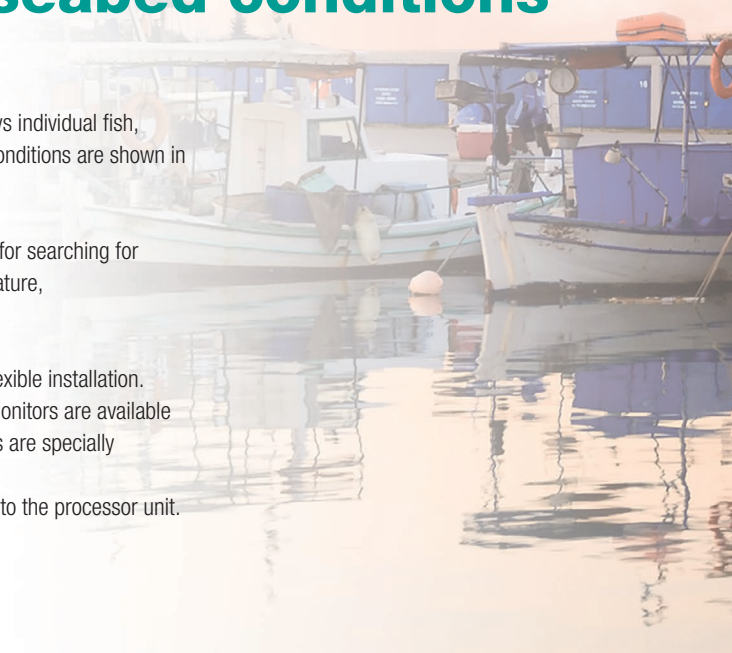

What is Scanning Sonar?

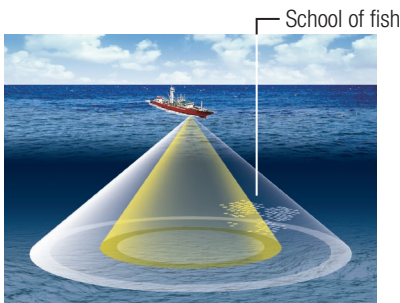

Detection image of scanning sonar

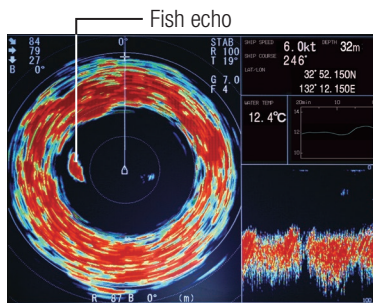

Fish echo displayed on CSH-5L MARK-2

The transducer of a scanning sonar consists of many elements to transmit the echo in all directions simultaneously without rotating the transducer. The echo is redrawn on the display instantaneously according to the latest feedback from the transducer. Because this sonar scans quickly, it greatly improves the fishing operation, especially when searching for/following fast swimming fish.

► Extremely Quick Scanning Speed

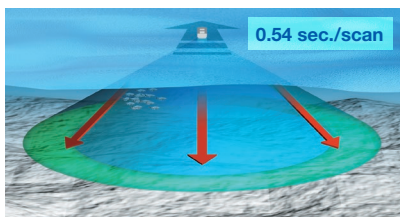

The CSH-5L MARK-2 completes a scan within 0.54 seconds/scan while the conventional PPI sonar^{*1} takes 32 seconds to train full circle under the same range/conditions^{*2}. About 60 times more information is provided compared to a PPI sonar. Fast scanning lessens the chance of missing a small change in underwater conditions. This is especially helpful when range and tilt require frequent adjustment while fishing, offering no frustration on redrawing time.

*1 CH-250 PPI sonar, training at 6° steps.
*2 Based on 400 m range in combination display mode.

► No Blind Area

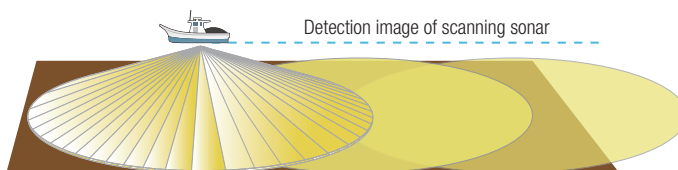

Scanning Sonar shows the actual situation 360 degrees around the vessel, and gives all the necessary information as needed. No more blind areas to consider, allowing the operator to concentrate on the tilt, range, fishing area, etc.

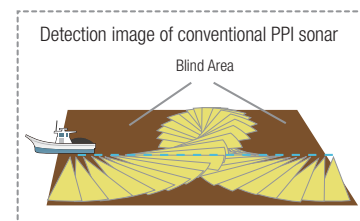



With the CSH-5L MARK-2 you can confidently fish in shallow areas and increase your catch.

Steep shoal

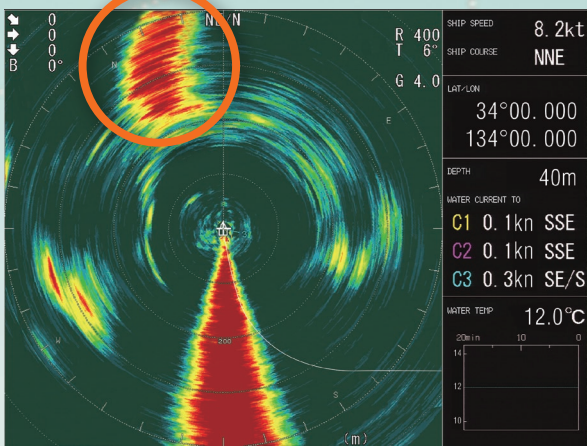

To the top left a steep shoal is visible. The vessel follows its structure in order to find fish close by.

Schools of round herring

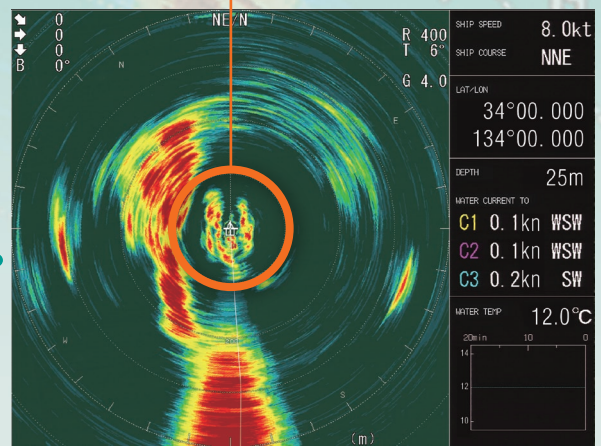

Schools of round herring close to the shoal can be seen here. The vessel has turned on its lights to attract the fish.

Easy-to-Use Controls

The control unit of CSH-5L MARK-2 combines ergonomics and functions in a user-friendly manner. All controls quickly respond to the operator's command and the associated reaction can be seen on the screen immediately. Four user-defined functions can be assigned to Function keys (F1 to F4), providing for rapid setup and operation.

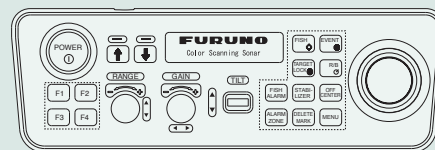

The optional remote controller provides armchair control of the tilt, range and gain.

Model **CSH-5L MARK-2**

SPECIFICATIONS

1.PROCESSOR UNIT

Display Mode Single scan, Echo sounder combination* (single scan and echo sounder), Audio combination (single scan and audio pictures)
*Echo sounder/Fish finder required

Colors Scan/echo: 16 colors, mark: 1 color

Mark Own ship's track, Heading line, Direction/distance, Fish school, Event, Target lock

Menu Language English, Japanese, Spanish, Danish, Dutch, French, Italian, Norwegian, Thai, Vietnamese, Burmese, Indonesian

2.TRANSCEIVER UNIT

Sonar Frequency 55 or 68 kHz

Range Scales 50, 85, 100, 150, 200, 250, 300, 350, 400, 450, 500, 600, 800, 1000, 1200, 1600 m

Pulselength 0.5 to 20 ms (depending on range scales)

Ship Speed 18 kn max (raise/lower operation up to 16 kn)

Tilt Manual control: 0° to 55° in 1° steps
Automatic tilt scan: 4° to 52°

Audio Search Sector: 20°, 40°, 80° and 120° selectable
Audio Output: 2 W, Frequency: 800 Hz

3.INTERFACE

Input Data NMEA 0183 Ver2.0/2.2
RMC, VHW, VTG, HDG, HDM, HDT, DPT, DBT, DBS, CUR, VDR, GLC, GTD, MTW, RMA

Log, E/S, KP Speed log pulse (contact signal): 200/400 pulse/NM
Sonde, E/S signal: VI-1100 A applicable
External KP: Current loop, 0 to 12 V

Output Data NMEA 0183 Ver1.5/2.0/2.2
TLL

Video Signal Output
Method RGB analog, separated synchronization, XGA (VESA)
Resolution 1024 x 768, 65.0 MHz clock

4.POWER SUPPLY

100/115/200/220/240 VAC, (Standard supply)
50-60 Hz, 0.4 kVA (Raise 1 kVA)
24 VDC (with optional DC-AC inverter)

EQUIPMENT LIST

Standard

1. Processor Unit CSH-5210-A
2. Control Unit CSH-5211-A
3. Transceiver Unit CSH-5130-A-5L
4. Preamplifier CSH-5020-A
5. Hull Unit 400 mm or 600 mm travel
6. Installation Materials, Accessories and Spare Parts

NOTE: Display Unit is not supplied as standard.

Option

1. DC-AC Inverter TR-2451
2. E/S Interface Unit VI-1100A
3. Aluminum Tank OP10-5 *1.0M*
4. External Loudspeaker
5. Transducer Cable Extension Kit
6. Motion Sensor MS-100
7. Remote Controller CSH-7040

Interconnection Diagram

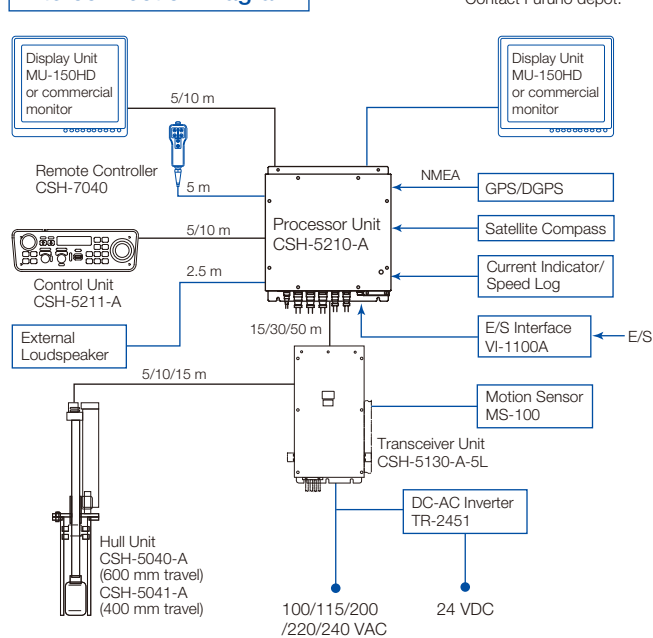

Transceiver Unit

CSH-5130-A-5L
20 kg 44.1 lb

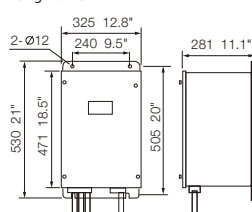

Hull Unit

CSH-5040-A (600 mm travel)
75 kg 165 lb

CSH-5041-A (400 mm travel)
70 kg 154 lb

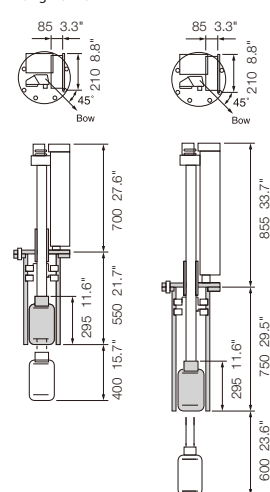

Control Unit

CSH-5211-A
3.5 kg 7.7 lb

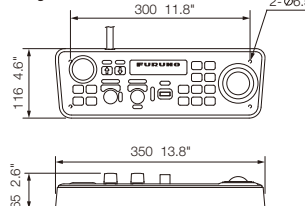

Preamplifier

CSH-5020-A
6.5 kg 14.3 lb

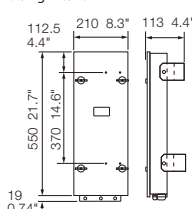

Processor Unit

CSH-5210-A
3.4 kg 7.5 lb

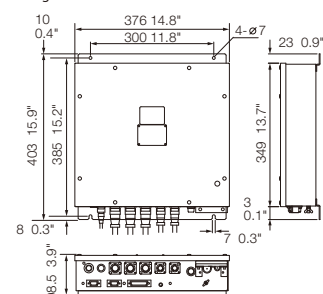

Beware of similar products

All brand and product names are registered trademarks, trademarks or service marks of their respective holders.

SPECIFICATIONS SUBJECT TO CHANGE WITHOUT NOTICE

FURUNO ELECTRIC CO., LTD.
Nishinomiya, Hyogo, Japan
www.furuno.com

FURUNO U.S.A., INC.
Camas, Washington, U.S.A.
www.furunousa.com

FURUNO (UK) LIMITED
Havant, Hampshire, U.K.
www.furuno.co.uk

FURUNO FRANCE S.A.S.
Bordeaux-Mérignac, France
www.furuno.fr

FURUNO ITALIA S.R.L.
Gatteo Mare, Italy
www.furuno.it

FURUNO ESPAÑA S.A.
Madrid, Spain
www.furuno.es

FURUNO DANMARK A/S
Hvidovre, Denmark
www.furuno.dk

FURUNO NORGE A/S
Ålesund, Norway
www.furuno.no

FURUNO SVERIGE AB
Västra Frölunda, Sweden
www.furuno.se

FURUNO FINLAND OY
Espoo, Finland
www.furuno.fi

FURUNO POLSKA Sp. Z o.o.
Gdynia, Poland
www.furuno.pl

FURUNO EURUS LLC
St. Petersburg, Russian Federation
www.furuno.com.ru

FURUNO SINGAPORE
Singapore
www.rico.com.sg

FURUNO DEUTSCHLAND GmbH
Rellingen, Germany
www.furuno.de

FURUNO HELLAS S.A.
Piraeus, Greece
www.furuno.gr

FURUNO (CYPRUS) LTD
Limassol, Cyprus
www.furuno.com.cy

FURUNO SHANGHAI CO., LTD.
Shanghai, China
www.furuno.com/cn

15053SK Printed in Japan
Catalogue No. E-419