

FURUNO

OPERATOR'S MANUAL

FACSIMILE RECEIVER

MODEL **FAX-408**

ECF

(Elemental Chlorine Free)

The paper used in this manual
is elemental chlorine free.

FURUNO ELECTRIC CO., LTD.

9-52 Ashihara-cho,
Nishinomiya, 662-8580, JAPAN

Telephone : +81-(0)798-65-2111

Fax : +81-(0)798-65-4200

• FURUNO Authorized Distributor/Dealer

All rights reserved. Printed in Japan

Pub. No. OME-62620-B

(AKMU) FAX-408

A : SEP . 2006

B : JUN . 15, 2009



* 0 0 0 1 6 1 6 0 8 1 1 *

IMPORTANT NOTICES

General

- The operator of this equipment must read and follow the descriptions in this manual. Wrong operation or maintenance can cancel the warranty or cause injury.
- Do not copy any part of this manual without written permission from FURUNO.
- If this manual is lost or worn, contact your dealer about replacement.
- The contents of this manual and equipment specifications can change without notice.
- The example screens (or illustrations) shown in this manual can be different from the screens you see on your display. The screens you see depend on your system configuration and equipment settings.
- Save this manual for future reference.
- Any modification of the equipment (including software) by persons not authorized by FURUNO will cancel the warranty.
- All brand and product names are trademarks, registered trademarks or service marks of their respective holders.

How to discard this product

Discard this product according to local regulations for the disposal of industrial waste. For disposal in the USA, see the homepage of the Electronics Industries Alliance (<http://www.eiae.org/>) for the correct method of disposal.

How to discard a used battery

Some FURUNO products have a battery(ies). To see if your product has a battery(ies), see the chapter on Maintenance. Follow the instructions below if a battery(ies) is used.

In the European Union

The crossed-out trash can symbol indicates that all types of batteries must not be discarded in standard trash, or at a trash site. Take the used batteries to a battery collection site according to your national legislation and the Batteries Directive 2006/66/EU.

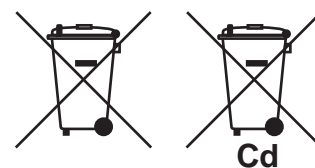

In the USA

The Mobius loop symbol (three chasing arrows) indicates that Ni-Cd and lead-acid rechargeable batteries must be recycled. Take the used batteries to a battery collection site according to local laws.

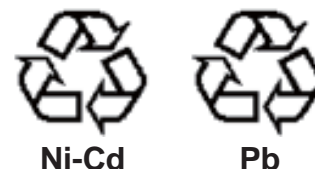

In the other countries

There are no international standards for the battery recycle symbol. The number of symbols can increase when the other countries make their own recycle symbols in the future.



SAFETY INSTRUCTIONS

The user and installer must read the appropriate safety instructions before attempting to install or operate the equipment.



WARNING

Indicates a potentially hazardous situation which, if not avoided, could result in death or serious injury.



CAUTION

Indicates a potentially hazardous situation which, if not avoided, may result in minor or moderate injury.



Warning, Caution



Prohibitive Action



Mandatory Action

Safety Instructions for the Operator



WARNING



Do not open the equipment except to replace paper.

Only qualified personnel should work inside the equipment.



Immediately turn off the power at the switchboard if water leaks into the equipment or something is dropped into the equipment.

Continued use of the equipment can cause fire or electrical shock. Contact a FURUNO agent for service.



Do not disassemble or modify the equipment.

Fire, electrical shock or serious injury can result.



Do not place liquid-filled containers on the top of the equipment.

Fire or electrical shock can result if a liquid spills into the equipment.



Immediately turn off the power at the switchboard if the equipment is emitting smoke or fire.

Continued use of the equipment can cause fire or electrical shock. Contact a FURUNO agent for service.



WARNING



Make sure no rain or water splash leaks into the equipment.

Fire or electrical shock can result if water leaks in the equipment.



Use the proper fuse.

Use of a wrong fuse can result in damage to the equipment or cause fire.





Handle the LCD with great care. Strong shock may break it.

If the LCD breaks, LCD liquid may leak out. Do not swallow or touch the liquid - it is toxic if swallowed. If it is swallowed or contacts eyes, rinse the contacted area thoroughly with water and contact a physician immediately.



The power supply shall conform to the recommended rating.

Fire or electrical shock may result if an improper power supply is used.

 CAUTION	
	Do not use commercial cleaners to clean the main unit.
	Commercial cleaners may remove paint and markings. Remove dust from the main unit with a soft cloth. For stubborn dirt, use water-diluted mild detergent and a soft cloth.

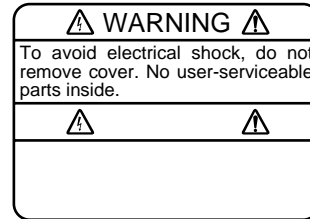

WARNING LABEL

A warning label is attached to the main unit. Do not remove the label. If the label is missing or damaged, contact a FURUNO agent or dealer about replacement.



Name: Warning Label 1
 Type: 86-003-1011-2
 Code No.: 100-236-232-10

Safety Instructions for the Installer

 WARNING	
	Turn off the power at the switchboard before beginning the installation.
	Fire or electrical shock can result if the power is left on.



 CAUTION		
	Observe the following compass safe distances to prevent interference to a compass:	
	Standard compass	Steering compass
Facsimile Receiver	0.7 m	0.5 m
	Observe the following cautions when choosing a mounting location:	
	<ul style="list-style-type: none"> - Locate away from area subject to rain or water splash. - Provide adequate ventilation. - Locate out of direct sunlight. - Choose location where shock and vibration are minimal. 	

TABLE OF CONTENTS

FOREWORD	vi
EQUIPMENT LIST	vii
SYSTEM CONFIGURATION	viii
1. OPERATION	1
1.1 Control Description	1
1.2 Turning the Power On/Off.....	3
1.3 Adjusting LCD Contrast	3
1.4 Adjusting LCD Brilliance and LED Brightness	3
1.5 Channel and Frequency Displays.....	3
1.5.1 Channel setting.....	3
1.5.2 Selection of desired frequency, fine adjustment of frequency	4
1.6 Automatic Receiving	4
1.7 Manual Receiving	5
1.8 Timer Receiving.....	5
1.8.1 Registering timer programs	5
1.8.2 Choosing timer programs for timer reception	6
1.8.3 Disabling timer operation when awaiting reception	7
1.8.4 Unlocking the keyboard during timer reception	7
1.8.5 Confirming timer programs	7
1.9 Processing Facsimile Images.....	8
1.9.1 Speed and IOC.....	8
1.9.2 Manual phasing	9
1.9.3 Synchronization	9
1.9.4 Reverse mode	9
1.10 Sleep Timer	10
1.10.1 Activating the sleep timer	10
1.10.2 Unlocking the keyboard.....	10
1.10.3 Disabling the sleep timer	10
1.11 Setting the Date and Time.....	11
1.12 Adding Facsimile Channels	11
1.13 ISB Function	13
1.13.1 Enabling, disabling ISB function	13
1.13.2 Setting ISB shift width.....	13
1.14 Operation with an External Receiver	14
1.14.1 Enabling, disabling external receiver use	14
1.14.2 Operation.....	14
2. MAINTENANCE	15
2.1 Cleaning	15
2.2 Replacement of Recording Paper	15
2.3 Replacement of Fuse	16
2.4 Backup Battery	19
2.5 Clearing the RAM	19

3. INSTALLATION.....	21
3.1 Main Unit.....	21
3.2 Antenna.....	22
3.2.1 General antenna connection	22
3.2.2 Whip or wire antenna	23
3.2.3 Installation of optional preamp unit (FAX-5).....	23
3.3 Wiring.....	24
3.3.1 Power, ground.....	24
3.3.2 External equipment	24
3.3.3 Whip or wire antenna	25
3.3.4 Setting of SW S1 on RCV board (when preamp unit is used).....	26
3.4 Changing Display Language	27
 FACSIMILE STATION TABLES	 29
 SPECIFICATIONS.....	 SP-1
 PACKING LIST.....	 A-1
 OUTLINE DRAWINGS	 D-1
 INTERCONNECTION DIAGRAM.....	 S-1

FOREWORD

A Word to the Owner of the FAX-408

FURUNO Electric Company thanks you for purchasing the FURUNO FAX-408 Facsimile Receiver. We are confident you will discover why the FURUNO name has become synonymous with quality and reliability.

For over 60 years FURUNO Electric Company has enjoyed an enviable reputation for quality and reliability throughout the world. This dedication to excellence is furthered by our extensive global network of agents and dealers.

Your equipment is designed and constructed to meet the rigorous demands of the marine environment. However, no machine can perform its intended function unless properly installed and maintained. Please carefully read and follow the operation, installation and maintenance procedures set forth in this manual.

We would appreciate feedback from you, the end-user, about whether we are achieving our purposes.

Thank you for considering and purchasing FURUNO.

Features

The FAX-408 uses an Individual scanning recording thermal head to produce high quality facsimile images.

- Electronic scanning with thermal head recording system provides clear image, quiet operation.
- Programmed with all existing facsimile stations and frequencies. User may also program channels and edit existing channels.
- Fully automatic facsimile operation with built-in schedule timer. Storage for 16 timer programs.
- Fully automatic selection of speed, IOC, phase alignment and frequency. Manual selection also available.
- 9-tone gradation recording provides clear and detailed weather images.
- ISB shift function tracks frequency of SSB multiplex broadcasts whose frequencies typically shift 1-2 kHz.
- Signal from external receiver may also be recorded.
- Automatic start/stop circuit provided in accordance with WMO standard.

EQUIPMENT LIST

Standard supply

Name	Type	Code No.	Qty	Remarks
Facsimile Receiver	FAX-408	—	1	
Installation Materials	CP08-02101	000-163-087	1 set	See the Packing Lists at the end of this manual.
Accessories	FP08-01000	000-163-088	1 set	
Spare Parts	SP08-02301	000-163-082	1 set	

Optional supply

Name	Type	Code No.	Remarks
Preamp Unit	FAX-5	000-075-016	w/15 m cable
	FAX-5	000-075-049	w/1 m cable
Whip Antenna	04S4176	000-153-122	2.6 m, for use with FAX-5
	FAW-6R2	000-572-108	6 m
	FAW-6R2A	000-107-921	6 m, w/mounting bracket
Hose Clamp	OP08-11	005-946-960	For mounting preamp unit
Matching Box	ARD-1	005-502-230	
Antenna Cable Extension Kit	OP04-2 *10M*	000-041-174	10 m, 3D-2V, w/MP3 connector at both ends
	OP04-2 *20M*	000-041-175	20 m, 3D-2V, w/MP3 connector at both ends
	OP04-2 *30M*	000-041-176	30 m, 3D-2V, w/MP3 connector at both ends
	OP04-2 *40M*	000-041-177	40 m, 3D-2V, w/MP3 connector at both ends
	OP04-2 *50M*	000-041-178	50 m, 3D-2V, w/MP3 connector at both ends
Coaxial Plug	FM-MP-7	000-108-859	
Adapter	MP-M3A	000-108-860	
	MP-M5A	000-108-861	
Rectifier	PR-62	000-013-484	100 VAC
		000-013-485	110 VAC
		000-013-486	220 VAC
		000-013-487	230 VAC
Connector (M)	FMA-1	000-152-964-00	

SYSTEM CONFIGURATION

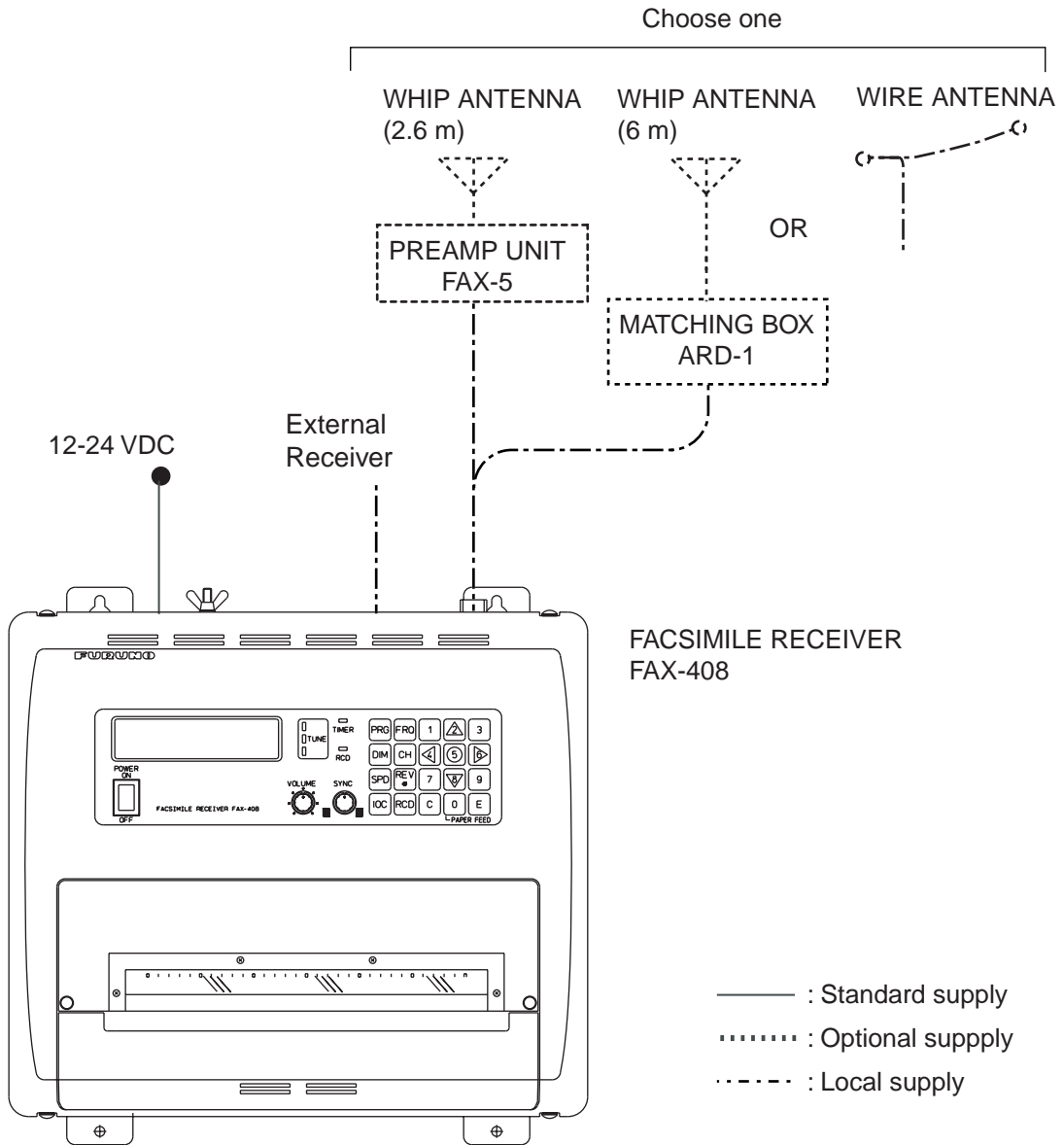

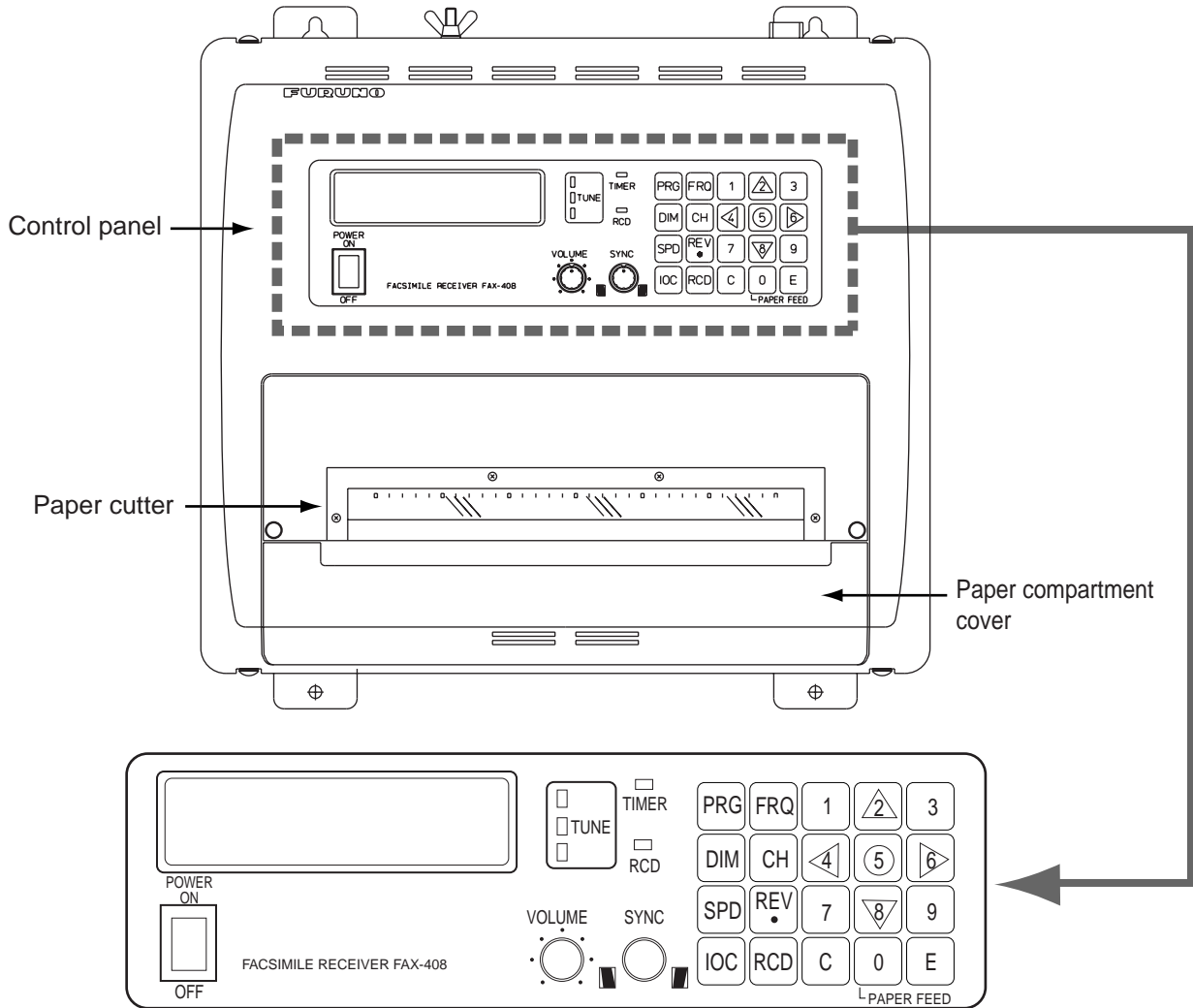

1. OPERATION

1.1 Control Description





















Control description

Control, indicator	Description
	Turns power on and off.
	Adjusts volume of Rx signal and key beep.
	Fine tunes the phasing signal.

1. OPERATION

Control description (con't from previous page)

Control, indicator	Description
	<ul style="list-style-type: none"> Enables a setting mode (in combination with numeric key). Press the key followed by appropriate numeric key to choose setting mode. <ol style="list-style-type: none"> Chooses internal or external receiver. Sets timer reception functions. Sets sleep timer. Adds or edit channels. Sets date and time. Sets ISB shift. Adjusts LCD contrast. Clears RAM. Returns to top page in setting mode.
	<ul style="list-style-type: none"> Changes from channel mode to frequency mode. Sets frequency in frequency mode.
	Adjust LCD brilliance and LED brightness, in five levels.
	<ul style="list-style-type: none"> Changes from frequency mode to channel mode. Sets channel in channel mode.
	Chooses recording speed.
	<ul style="list-style-type: none"> Reverses recording format (from black on white to white on black and vice versa). Inserts decimal point when entering frequency, asterisk when entering channel. Chooses + or -.
	Chooses IOC (Index of Cooperation).
	Starts and stops recording in manual recording.
	Confirms setting.
	<ul style="list-style-type: none"> Clears data in setting mode. Switches from setting mode to standby mode.
	Raises channel in channel mode, or raises frequency in frequency mode.
	Manual phasing (leftward) in recording. Each press shifts the recording leftward by about 5 mm.
	Displays date and time.
	Manual phasing (rightward) in recording. Each press shifts the recording rightward by about 5 mm.
	Lowers channel in channel mode, or lowers frequency in frequency mode.
	Feeds paper.
	The top, middle or bottom LED lights when the receive frequency is higher, the same or lower than programmed frequency, respectively.
	Lights when the timer mode or sleep mode is active.
	<ul style="list-style-type: none"> Flashes when receiving start signal. Lights when recording is in progress.

1.5.2 Selection of desired frequency, fine adjustment of frequency

Frequency may also be entered manually by pressing the **FRQ** key, and then entering frequency by using the numeric keys and the **REV/.** key (for entering decimal point). The available frequency range is 2000.0 - 24999.9 kHz.

In the frequency display mode, use the **▲** or **▼** key to fine tune a frequency when in the frequency display mode, in resolution of 0.1 kHz. When properly tuned, the center TUNE LED (green) lights. If the upper TUNE LED (red) is lit, use the **▲** key, and if the lower TUNE LED (red) is lit, use the **▼** key.

1.6 Automatic Receiving

Once you choose the facsimile station from which to receive, the system goes into standby to await the start signal from the facsimile station. Recording starts when the start signal is received.

1. Press the **CH** key to show the channel display.

C00*	JMH	3622.5
S120	I576	

* Asterisk indicates automatic frequency selection.

2. Press the **▲** or **▼** key to choose channel desired.

Note: Alternatively, you may enter the frequency of the broadcasting station by pressing the **FRQ** key and entering frequency with the numeric keys and the **REV/.** key (for decimal point).

When the start signal is received, the message "AUTO START SEARCHING FRAME" appears and the RCD LED (orange) flashes. Speed and IOC are automatically adjusted when recording starts. The RCD LED lights during recording.

Note: The TUNE LED goes off when the RX level goes below a certain level or the equipment is not receiving. Even if the TUNE LED goes off, the equipment records the fax signal as long as the S/N ratio is suitable. Therefore, this is not a sign of TUNE LED trouble or equipment malfunction.

Stopping recording

Recording stops automatically when the stop signal is received. You may also stop the recording manually by pressing the **RCD** key. The RCD LED goes off when recording is stopped.

1.7 Manual Receiving

This section shows you to manually receive a facsimile broadcast. For example, you may want to receive a facsimile broadcast already in progress or receive from a facsimile station that does not use start and stop signals.

1. Press the **CH** key to show the channel display.

C000	JMH	3622.5
S120	I576	

2. Press the **▲** or **▼** key to choose channel desired.

Note: Alternatively, you may enter the frequency of the broadcasting station by pressing the **FRQ** key and entering frequency with the numeric keys and the **REV/•** key (for decimal point).

3. Press the **RCD** key to start receiving.

MANUAL START SEARCHING FRAME appears on the display and the RCD LED (orange) flashes.

4. If recording does not start after a while, press the **RCD** key again. The RCD LED stops flashing and lights when recording starts.
5. If necessary, use the **SPD** key and **IOC** keys to choose rotation speed and IOC, respectively, referring to paragraph 1.9.1.

Stopping recording

Recording stops automatically when the stop signal is received. To stop recording manually, press the **RCD** key. The RCD LED goes off when recording is stopped.

1.8 Timer Receiving

Most facsimile stations transmit facsimile images in accordance with a schedule issued by relative meteorological observatory. (You can find facsimile schedules in the publication "Meteorological Facsimile Broadcasts," available through meteorological observatory bodies.) If you wish to receive a certain facsimile broadcast on a regular basis, therefore, the timer mode will virtually allow you "hands-off" automatic operation. 16 timer programs may be set.

1.8.1 Registering timer programs

1. Press the **PRG** key to display the setting mode.

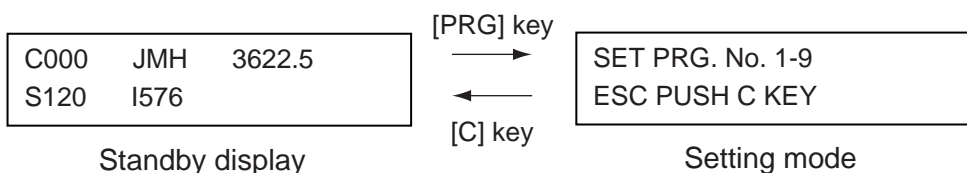

2. Press the **2** key to show the timer reception setting mode.

TIMER	RCV : 1-OFF
2-ON	3-RCL 4-STR

1. OPERATION

3. Press the **4** key to choose STR (Store).

```
STORE TIMER REG
SET REG No. 0-F
```

4. Use the **▲** or **▼** key to choose timer program number and press the **E** key. For example, choose "1" and the display then looks something like the one below.

```
R1 SET CHANNEL
No. in 3 FIGURES
```

5. Enter a channel number and press the **E** key.

```
R1 C000 SET DAY
of THE WEEK by ▲▼
```

6. Set the day of the week which to receive the program, using the **▲** or **▼** key. Choose the asterisk (*) to get a broadcast daily at the same time.

7. Press the **E** key.

```
R1 C000 MON
SET START/STOP
```

8. Set start and stop times, in 24-hour notation, using the numeric keys. (When registering programs which follow one another consecutively, the time between programs should be set at least one minute apart. For example, you have two programs to register, the first at 12:00-12:30 and the second at 12:30-13:00. In this case, set the time for the second program to 12:31-13:00.)

9. Press the **E** key.

10. Press the **C** key.

1.8.2 Choosing timer programs for timer reception

Choose timer programs to use in timer reception as follows:

1. Press the **PRG** key and the **2** key to show the timer reception setting mode.

```
TIMER RCV : 1-OFF
2-ON 3-RCL 4-STR
```

2. Press the **2** key to choose ON.

```
SET REG No. 0-F
PUSH ▲/▼&▶& E KEY
```

3. Use the **▲** or **▼** key to choose timer program number to activate, and press the **▶** key.

```
TIMER RCV No.: 4
4
```

4. Repeat step 3 as necessary to choose other programs.
5. After choosing all programs necessary, press the **E** key.

The start and stop times of the earliest program are displayed. The TIMER LED (orange) lights when timer recording is enabled. Note that all keys except the **PRG** key are locked.

1.8.3 Disabling timer operation when awaiting reception

Timer programs may be deleted from the timer reception schedule as follows.

1. Press the **PRG** key, and the message shown below appears.

TIMER RCV : OFF?
PUSH E KEY

2. Press the **E** key.

1.8.4 Unlocking the keyboard during timer reception

All keys except the **PRG** key are locked during recording to prevent accidental adjustment of the equipment. If you need to operate the keyboard when timer reception is active, do the following:

1. Press the **PRG** key, and the following screen appears.

KEY LOCK : OFF?
PUSH E KEY

2. Press the **E** key to unlock the keyboard.

1.8.5 Confirming timer programs

Do the following to confirm timer programs that you have entered.

1. Press the **PRG** key and the **2** key to show the timer reception setting mode.
2. Press the **3** key to choose RCL (Recall).

RECALL TIMER REG
SET REG No. 0-F

3. Use the **▲** or **▼** key to choose timer program number, and the contents of the timer program selected are displayed.
4. Press the **C** key several times to return to the standby display.

1.9 Processing Facsimile Images

Speed, IOC, phasing, synchronization and image format may be adjusted during recording.

1.9.1 Speed and IOC

Choose the correct speed and IOC, otherwise the image will be received as shown in the illustration below.

Wrong Speed or IOC and Image

Wrong speed: "60" chosen instead of "120"

Two images are displayed.

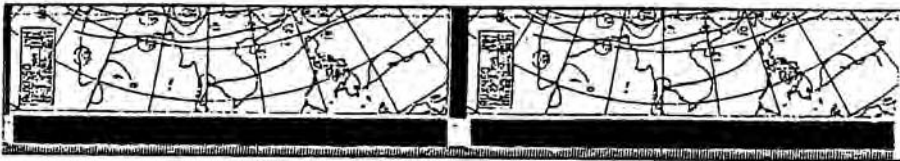

Wrong speed: "120" chosen instead of "60"

Overlapped image appears.



Wrong IOC

The image will be extended (or foreshortened) when "288" (or 576) is selected for transmission with the IOC of "576 (or 288)."



Speed

Speed is the rotation speed of the drum (on which the original image is fitted) at the facsimile transmitter: 60, 90 or 120 rpm. To choose speed, do the following:

1. Press the **SPD** key to show the speed display.

SPEED: 120 1-120 2-90 3-60

2. Press the **1**, **2** or **3** key as appropriate to choose correct speed.

IOC

IOC is an acronym meaning Index of Cooperation, and it is the line density standard assigned by WMO: IOC 576, high density, IOC 288, low density. To choose IOC, do the following:

1. Press the **IOC** key to show the IOC display.

```

IOC: 576
1-576  2-288
  
```

2. Press the **1** or **2** key to choose appropriate IOC.

1.9.2 Manual phasing

When the FAX-408 starts recording a broadcast already in progress, or noise prevents detection of the phasing signal, a dead sector (black or white stripe) may appear on the recording. This phenomenon is due to phase mismatching. When this occurs, adjust recording position as shown below.

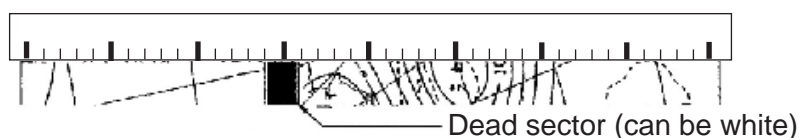

To adjust phasing, use the ◀ or ▶ key. Press ◀ to shift leftward; ▶ to shift rightward. Each press shifts the recording leftward (rightward) by about 5.0 mm.

1.9.3 Synchronization

If the dead sector is plotted at an angle even when the phase is properly selected, adjust the synchronization to display the dead sector straightly, using the **SYNC** control. Rotate the control counterclockwise if the picture is skewed leftward, or rotate it clockwise if the picture is skewed rightward.

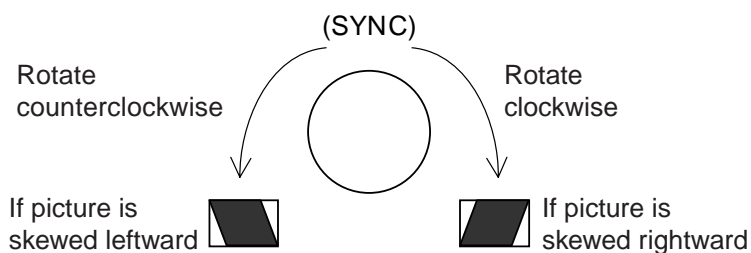

1.9.4 Reverse mode

Most facsimile stations transmit facsimile images with black text on a white background. Some stations, however, print reversely of that format. If you want to record a facsimile in a format different from how it is being received, do the following:

1. Press the **REV/•** key to display the screen shown below.

```

REVERSE: OFF
1-OFF  2-ON
  
```

2. Press the **1** key to turn OFF reverse or the **2** key to turn ON reverse.

1.10 Sleep Timer

The sleep timer feature sleeps the set after reception has passed. Fax signal will not be received when the sleep timer is active.

1.10.1 Activating the sleep timer

1. Press the **PRG** key.
2. Press the **3** key to show the sleep mode setting mode.

```
SLEEP MODE : OFF
1-OFF  2-ON
```

3. Press the **1** key to disable the sleep timer or the **2** key to enable it.
4. If the **1** key was pressed at step 3, press the **E** key to turn off the sleep mode. If the **2** key was pressed, the display shown below appears. Go to step 5.

```
SLEEP TIME:
SET SLEEP TIME
```

5. Using the numeric keys, set the amount of time (within 23h59m) to sleep the set. To sleep the set 30 minutes later, for example, enter [0], [0], [3], [0].
6. Press the **E** key.

The TIMER LED (orange) lights. IN SLEEP!! is displayed when the sleep function becomes active.

1.10.2 Unlocking the keyboard

All keys except the **PRG** key are locked when the sleep timer function is in standby (before specified time passes). To unlock the keyboard in this case, do the following:

1. Press the **PRG** key to show the following menu.

```
KEY LOCK : OFF?
PUSH E KEY
```

2. Press the **E** key to unlock the keyboard and enable all operations.

1.10.3 Disabling the sleep timer

To disable the sleep timer, do the following:

1. Press the **PRG** key to show the following menu.

```
SLEEP MODE : OFF
PUSH E KEY
```

2. Press the **E** key.

1.11 Setting the Date and Time

1. Press the **PRG** key.
2. Press the **5** key to display the screen shown below.

```

SET MONTH
by ▲/▼ KEY

```

3. Use the **▲** or **▼** key to set month, and press the **E** key.

```

FEB
SET DATE in 2FIG

```

4. Use the numeric keys to set date in two digits, and press the **E** key.

```

FEB 22 SET DAY
of THE WEEK by ▲▼

```

5. Use the **▲** or **▼** key to set day of the week, and press the **E** key.

```

FEB 22 WED '
SET YEAR in 2FIG

```

6. Use the numeric keys to set year in two digits, and press the **E** key.

```

:
SET TIME in 4FIG

```

7. Using 24-hour notation, enter time in four digits, and press the **E** key. The date and time appear momentarily.
8. Press the **C** key to return to the standby display.

1.12 Adding Facsimile Channels

The FAX-408 provides a free memory for the user to store newly added channels (164 max.). The procedure below shows how to add facsimile channels, using CH711 as an example.

1. Press the **PRG** key followed by the **4** key.

```

CHANNEL PROGRAM
SET CH in 3 FIGS

```

2. Enter channel number with the numeric keys, and press the **E** key. For example, enter 711.

```

C711 SET CALL S-
IGN by ▲▼•◀▶ KEY

```

3. Press any arrow key to go the call sign entry screen.

```

          Cursor (flashing)
          |
CALL SIGN: ■MH
          PUSH E KEY

```

1. OPERATION

4. Enter call sign (3 characters), using the arrow keys, and press the **E** key. (Use the ◀ or ▶ key to choose location (with the cursor); use the ▲ or ▼ key to change character.) For example, enter JMH, and the display should look something like the one below.

```
C711 JMH 0.0
SET FREQUENCY
```

5. Enter frequency, using the numeric keys and the **REV/•** key (for decimal point), and press the **E** key.

```
SET SPEED 120-60
1-120 2-90 3-60
```

6. Press the **1**, **2** or **3** key as appropriate to choose speed, and press the **E** key.

```
SET IOC 576/288
1-576 2-288
```

7. Press the **1** or **2** key as appropriate to choose IOC, and press the **E** key.

```
SET REVERSE
1-OFF 2-ON
```

8. Press the **1** key to print facsimile in the format it is received, or the **2** key for format reversal.
9. Press the **E** key. The data for the channel is momentarily displayed and then the setting mode display appears.
10. Press the **C** key to return to the standby display.

Existing channels may be edited similarly. Choose existing channel at step 2 and follow the remaining steps.

1.13 ISB Function

The frequency of certain SSB multiplex broadcasts (fax and teletype) randomly shifts 1-2 kHz. To receive these broadcasts steadily, enable the ISB* function to track frequency.

* ISB is a single sideband mode which is used with some SSB transmissions. Normally each sideband carries identical information, but ISB modulates two different input signals - one on the upper sideband, the other on the lower sideband.

1.13.1 Enabling, disabling ISB function

1. Press the **PRG** key followed by the **6** key.

ISB +0.0kHz : OFF
1-OFF 2-ON 3-QTY

2. Press the **1** or **2** key to disable or enable the ISB shift function, respectively.
3. Press the **E** key.
4. Press the **C** key.

When the ISB function is enabled, the ISB shift width set in the procedure below is applied to the frequency shown on the frequency display. Further, the frequency shift is applied to ALL channels.

1.13.2 Set ISB shift width

Set the ISB shift width (from nominal frequency) to use as follows:

1. Press the **PRG** key followed by the **6** key.
2. Press the **3** key to choose QTY.

SET ISB in 2FIGS
+/- by ● KEY

3. Press the **REV/•** key to display the + or – sign as appropriate.
4. Enter ISB shift width in two digits, using the numeric keys.
5. Press the **E** key.
6. Press the **C** key to return to the standby display.

1.14 Operation with an External Receiver

When the receive signal is particularly weak or the internal receiver is producing only blurred recordings, you may wish to receive facsimile broadcasts with an external receiver.

1.14.1 Enabling, disabling external receiver use

1. Press the **PRG** key followed by the **1** key.

AF IN : INT
1-INT 2-EXT

2. Press the **1** key to use the internal receiver, or press the **2** key to use an external receiver.
3. Press the **E** key.

1.14.2 Operation

Beat adjustment

When using an external receiver whose beat frequency is adjustable within a range of ± 2 kHz or more by means of a beat knob, set the frequency dial so the deflection of the receiver's S-meter is maximum, and adjust the beat knob so that the center LED of the tuning indicator of this unit is lit. When a signal from a station with ISB communication (U.S. Naval Station Guam, Pearl Harbor, San Francisco, etc.) is received, sometimes an adjustment of the frequency is necessary, with a variable condenser, because the frequency may shift from the nominal frequency of the station by ± 2 kHz.

Bandwidth

Increase bandwidth when noise is few, and lower bandwidth by about 1 kHz when noise is great.

Recording

Set up for recording referring to paragraph 1.6 (automatic) or paragraph 1.7 (manual). For reverse reception, set the mode on the external receiver to BFO (Beat Frequency Oscillator), or switch between LSB (Lower Sideband) and USB (Upper Sideband).

2. MAINTENANCE



WARNING

Do not open the equipment except to replace paper.

Only qualified personnel should work inside the equipment.

NOTICE

Do not apply paint, anti-corrosive sealant or contact spray to coating or plastic parts of the equipment.

Those items contain organic solvents that can damage coating and plastic parts, especially plastic connectors.

2.1 Cleaning

Dust and dirt may be removed from the main unit with a soft cloth. For stubborn dirt, water diluted mild detergent may be used. *DO NOT* use chemical-based cleaners to clean the cabinet or control panel, as they can remove paint and markings.

Random lines or dots appear on the recording when the thermal head is dirty. Clean the thermal head as shown in the procedure below, using the head cleaning sheet (#2000, supplied) and paper sensor jig, an ordinary white piece of paper cut and folded to the dimensions shown below.

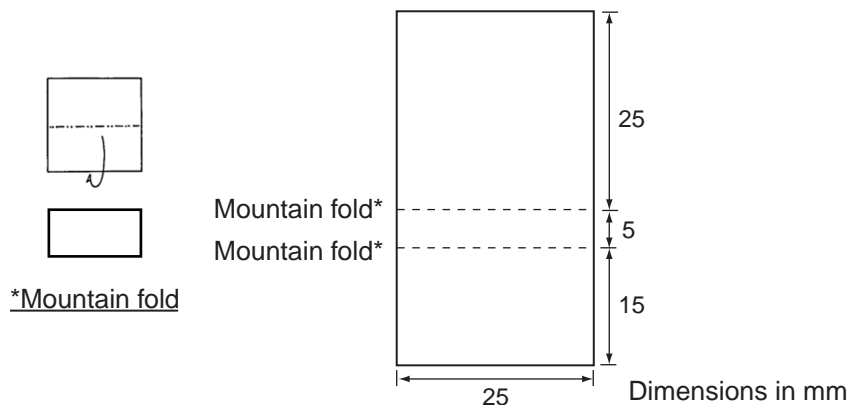

1. Turn off the power.
2. Unfasten two screws from the top of the unit and then remove paper compartment cover and paper cutter.
3. Push the paper release lever downward and detach roll paper.
4. With the longer end of the paper sensor jig up, set it to the paper feed slot as shown in the illustration on the next page. Confirm that the paper sensor jig is touching the paper stopper.
5. With the shiny side of the head cleaning sheet up, insert it above the paper sensor jig and continue inserting it until it comes out. Straighten the sheet if necessary.
6. Set the paper release lever upward.

2. MAINTENANCE

7. Turn on the power.
8. Press the **0** key until the sheet feeds out 5-15 cm.
9. Set the paper release lever downward and remove the head cleaning sheet and paper sensor jig.
10. Re-set the roll paper, paper compartment cover and paper cutter.

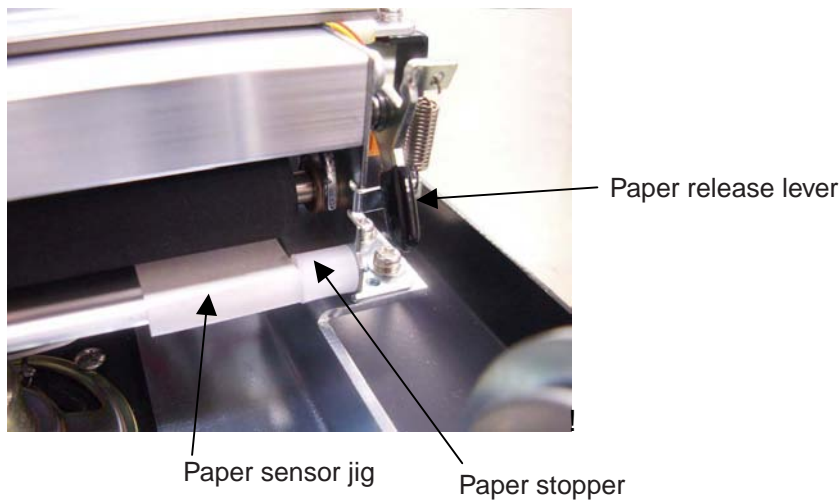

Note: Do not use the head cleaning sheet more than once per cleaning session and do not use a sheet whose grade is coarser than #2000. A coarser grade will damage the thermal head.

If the recording is still dirty

Turn off the power. Moisten a cotton swab with ethyl alcohol and insert between the thermal head and rubber roller, until about 4 mm of the swab is inserted. Move the swab to clean. **USE ONLY ethyl alcohol to clean.**

Use only a slight amount of ethyl alcohol. Excessive amount may dissolve corrosive components in printing chaff, which can damage the thermal head. Further, be sure the alcohol has dried completely before turning on the power.

2.2 Replacement of Recording Paper

Use only the recording paper specified by FURUNO. Use of other recording paper may degrade performance, damage the thermal head and prevent detection of "paper out".

When the paper is nearly out, the message PAPER OUT!! appears on the display and recording is automatically stopped. When about 3 m of paper remains, a red line of 2-3 mm in width begins to appear on the paper. When this happens, replace the paper as shown in the procedure on the next page.

Part name	Type	Code No.
Recording paper	TP-0820B	000-157-755-10

1. Open the paper cutter by loosening its two screws. Detach it together with the paper compartment cover. Put the paper feed lever in the downward position. See Figure 1.

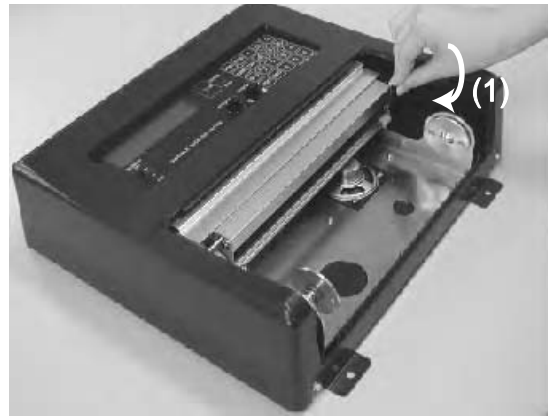

Figure 1

2. While pushing the paper guide (2) in the direction indicated, remove the remaining roll paper. See Figure 2.

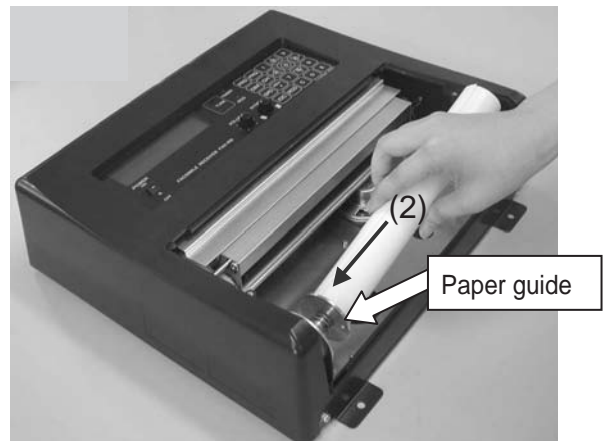

Figure 2

3. Pass the recording paper between the paper-end detector lever and rubber roller. Hold the edge of the paper which is above the roller and pull upward. See Figure 3.



Figure 3

2. MAINTENANCE

4. Pull the paper feed lever upward. Draw out the paper so that it will be a little past the front of the unit. See Figure 4.

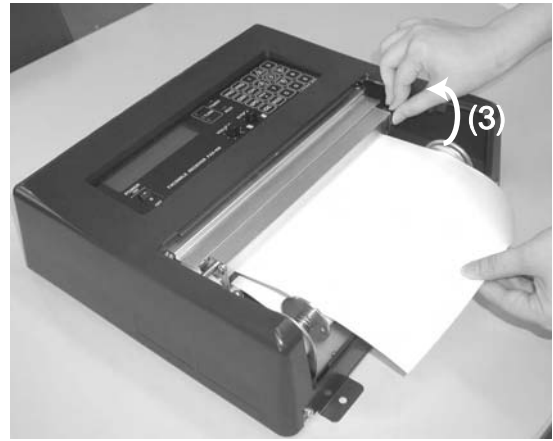

Figure 4

5. Attach the paper compartment cover. See Figure 5.



Figure 5

6. Attach the paper cutter and tighten its two screws. The recording paper should be protruding past the paper cutter. See Figure 6.
Note: The thermal head is weak against humidity and moisture. For this reason do not allow water or moisture near the recording paper, to prevent paper jam due to wet recording paper.



Figure 6

2.3 Replacement of Fuse

A fuse at the rear of the main unit protects the equipment from overcurrent and equipment fault. If the power cannot be turned on, the fuse may have blown.

 WARNING
<p>Use the proper fuse.</p> <p>Use of a wrong fuse can result in damage to the equipment or cause fire.</p>

Parts name	Type	Code No.
Fuse	FGBO 125V 7A PBF	000-155-831-10

2.4 Backup Battery

The manganese lithium battery inside the main unit is used to keep the clock running, and its life is about five years. When the battery voltage is low the time is "slow." Have a qualified technician replace the battery when this occurs.

Parts name	Type	Code No.
Battery	U130002 (CR-2032)	000-159-813

2.5 Clearing the RAM

The RAM stores frequency data of fax transmitting stations throughout the world. If part of the RAM was deleted in error, the data for fax transmitting stations can be retrieved from the ROM. In this case it is necessary to clear the RAM. Be sure that it is all right to clear the RAM as all data (frequency, etc.) stored there will be deleted.

1. Press the **PRG** key followed by the **9** key.

<p>RAM CLEAR !! PUSH E KEY</p>

2. Press the **E** key to clear the RAM.
3. Press the **C** key to return to the standby display.

Note: Do not confuse RAM error with keyboard lockup. The keyboard may lock if some abnormal operation is detected. If this occurs, turn the power off and on again.

2. MAINTENANCE

This page intentionally left blank.

3. INSTALLATION

3.1 Main Unit

The main unit may be mounted on a tabletop or a bulkhead, using 5×25 self-tapping screws (supplied).

When choosing a mounting location, consider the following points:

- It is essential that the mounting surface is flat, otherwise blurred recordings may result, as in the example below. If it is necessary to level the unit, insert flat washer (supplied) between unit and mounting surface at appropriate location(s).

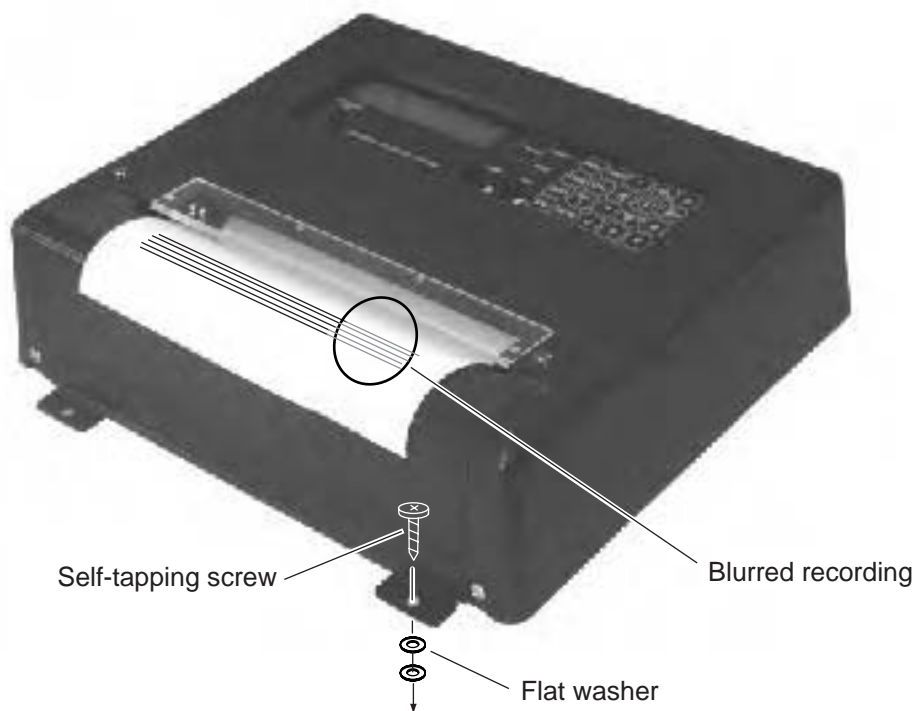

- Locate the unit out of direct sunlight because of heat that can build up inside the cabinet.
- For bulkhead mounting, be sure the mounting location is strong enough to support the unit under the vibration normally encountered on board the vessel.
- Choose a location where vibration and shock are minimal.
- Choose a location where the control panel can be easily operated.
- Leave sufficient space around the unit for servicing and maintenance. Refer to the outline drawing for recommended maintenance space.
- Locate the unit away from areas subject to water splash and rain.
- A magnetic compass will be disturbed if the unit is placed too close to it. Separate the unit from a magnetic compass by the distance noted on page iii to prevent interference to the compass.

3.2 Antenna

The performance of the facsimile receiver is directly related to the antenna installation. In general, the antenna should be installed as high as possible on the vessel, free from the influence of nearby antennas, rigging and masts. Be sure to locate the antenna well away from TX antennas and noise generating equipment. Pay particular attention to the antennas of MF and HF radio equipment - they can damage the facsimile receiver through induction. (For better protection against induction, use the preamp unit.)

The FAX-408 can use the following antennas:

- Preamp unit FAX-5 (optional supply) + 2.6 m whip antenna (optional supply)
- Whip antenna (6 m, optional supply)
- Wire antenna (local supply)

3.2.1 General antenna connection

Connect the antenna to the facsimile receiver as shown below.

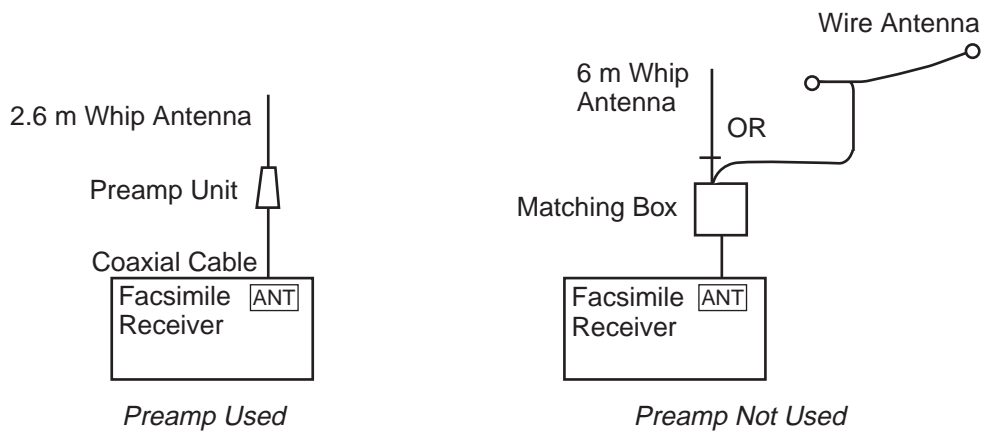

3.2.2 Whip or wire antenna

- Either a long wire or whip antenna may be used. A wire antenna should be 10 meters or longer including the vertical section. A whip antenna should be 6 meters long. Generally a whip antenna is suitable for reception over 6 MHz and wire antenna is suitable for reception under 6 MHz.
- The antenna can be shared with other receivers; use an antenna switch.
- If, when using a wire antenna, sensitivity is low, install the preamp unit (option).

3.2.3 Installation of optional preamp unit (FAX-5)

Small boats may not afford the space to install a long wire antenna. In this case it is recommended to install the preamp unit with 2.6 meter whip antenna. The preamp unit can be installed two ways:

- The base of the preamp unit is designed to accept a threaded extension of one-inch diameter. The pitch of the thread should be 14 threads per inch. The mast itself should be no longer than 1.5 meters to prevent flexing in heavy winds.
- Attach the preamp unit to a mounting post with stainless steel hose clamps (option).

Mounting

1. Fix the preamp unit to the mounting location.
2. Screw the whip antenna onto the preamp unit.
3. If the mast is metallic, run a ground wire (local supply) between the mast and the ground terminal on the preamp unit.
4. Waterproof the junction and other exposed metallic parts with silicone sealant.
5. Connect its coaxial cable directly to the antenna connector on the FAX-408. Note that an extension cable kit (option) is available, in lengths of 10, 20, 30, 40 and 50 m.

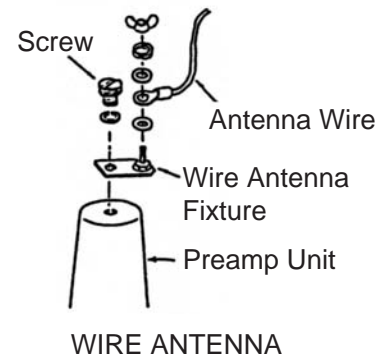
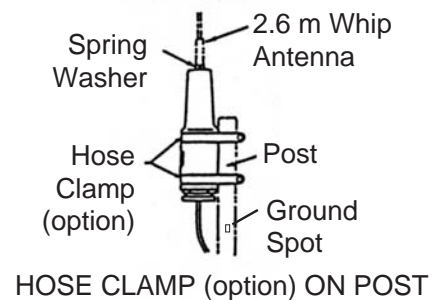
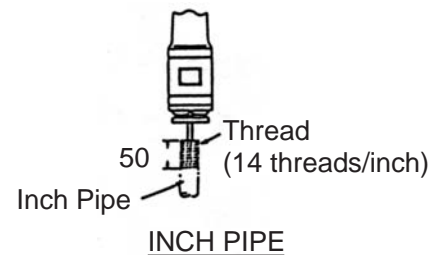

Note 1: A wire antenna several meters in length can be connected instead of the whip antenna. In this case, install the wire antenna fixture (supplied with preamp unit) between the antenna wire and the preamp unit as illustrated above.

Note 2: The preamp unit is powered by the facsimile receiver. To power the preamp unit, turn on the Switch S1 on the RCV board in the main unit. See page 24 for the location of the DIP switch.

3. INSTALLATION

3.3 Wiring

See the diagram on page S-1 for detailed wiring information.

3.3.1 Power, ground

Battery

Connect black wire to “-” (negative) and red wire to “+” (positive).

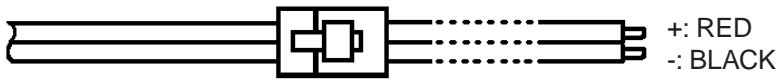

Ground

Run the ground wire (supplied) between the GND terminal at the rear of the main unit and ship's superstructure. Do not share ground with other equipment.

3.3.2 External equipment

External equipment, such as a receiver, are connected to the terminal at the rear of the main unit.

How to connect wiring to terminal

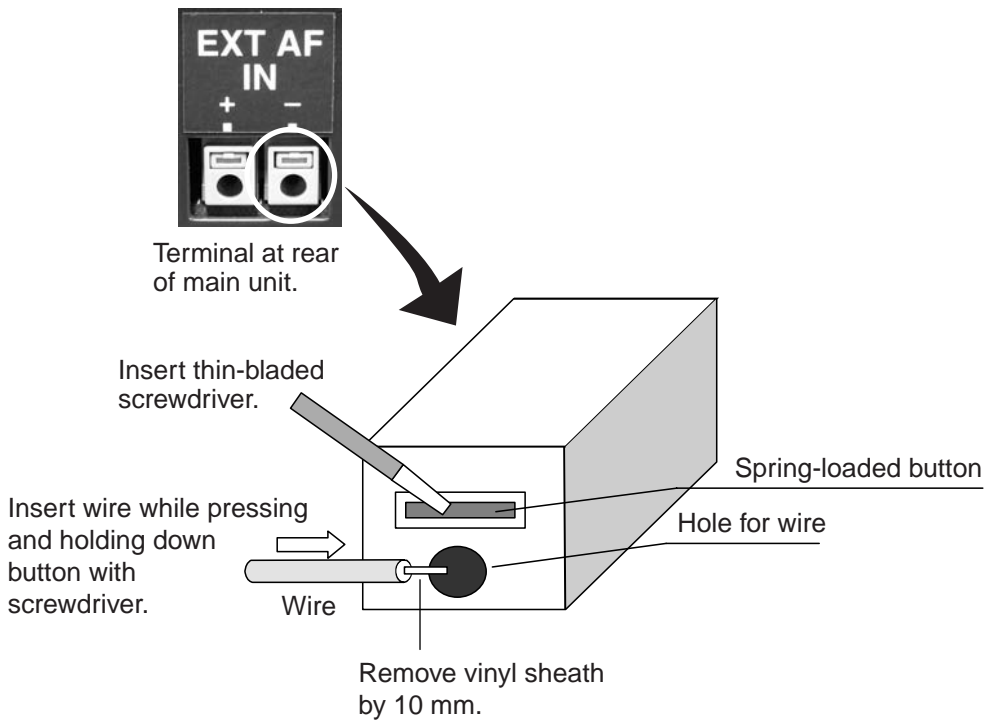

External receiver connection

An external receiver may be used in place of the internal receiver. In this case, the receiver should have a local oscillator with very good frequency stability. Connect the external receiver to the EXT AF IN terminal at the rear of the set. This terminal operates against an input of greater than 50 mV. Excessive input is protected with a protective circuit. However, if direct current is used, input should be passed through a non-polarized capacitor of about 1 μ F.

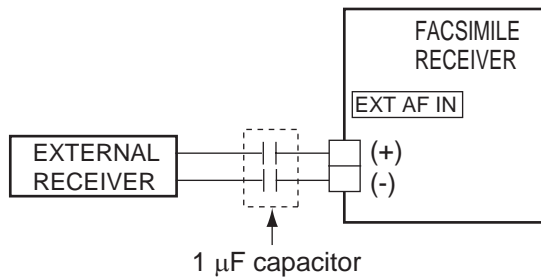

3.3.3 Whip or wire antenna

If the preamp unit is not used, a matching box is required. Connect a feeder line between the antenna and matching box. Attach a connector to the coaxial cable and connect it between the receiver and the antenna. Use coaxial cable RG-10/UY or RG-12/UY.

How to attach M-connector

1. Remove sheath by 30 mm.
2. Make the length of the conductor 23 mm. Expose braided shield by 5 mm.
3. Insert coupling ring onto cable.
4. Insert plug assembly onto cable.
5. Solder braided shield and plug assy. through hole in plug assembly.
6. Tighten coupling ring to plug assembly.

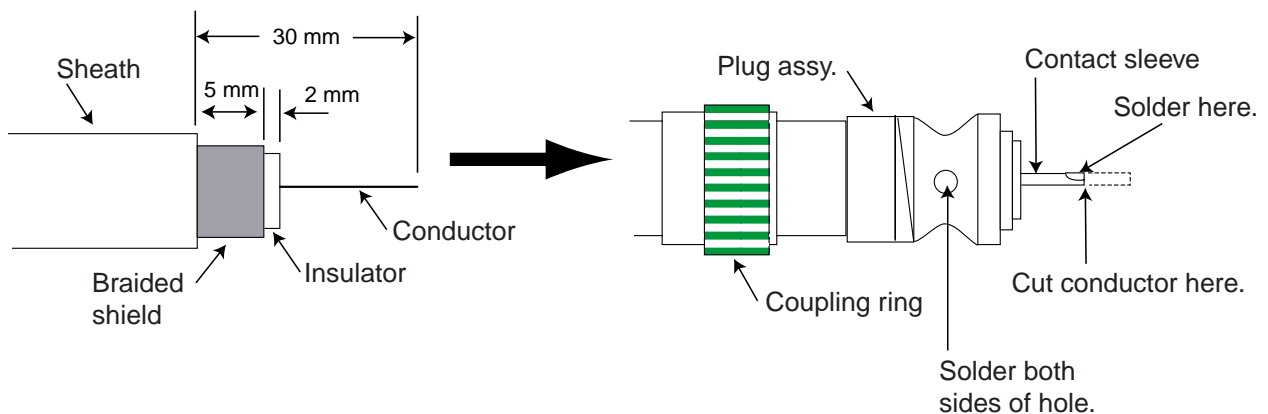

3. INSTALLATION

3.3.4 Setting of SW S1 on RCV board (when preamp unit is used)

If the preamp unit is installed, turn on SW S1 on the RCV board in the facsimile receiver to power the preamp unit.

1. Unfasten two screws marked with arrows in the figure below to detach the paper cutter and the paper compartment cover. Unfasten four screws to remove the main unit cover.

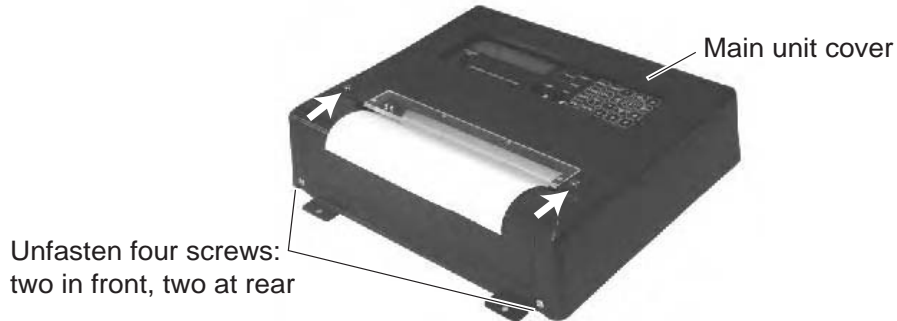

2. Unfasten four screws marked with arrows and pull the LCD assy. forward. Use a plastic-bladed screwdriver to change position of S1 to ON. Reassemble the unit.

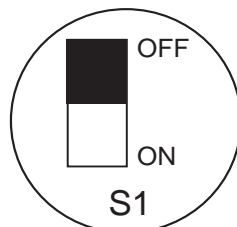

3.4 Changing Display Language

Display language is available in English, Dutch, Finnish, Norwegian, Swedish, Danish, Portuguese, Italian, German, Spanish and French, and the default language is English.

To change the display language, do the following:

1. Turn on the power while pressing and holding down the **PRG** key.

TEST MODE (HR3)
ESC POWER OFF

2. Press the **8** key to show the following display.

LANG: English
PUSH ▲/▼ &E KEY

3. Use the **▲** or **▼** key to choose language desired.
4. Press the **E** key.
5. Turn off the power and turn it on again.

3. INSTALLATION

This page intentionally left blank.

FACSIMILE STATION TABLES

This section shows the location and frequency data of all the existing frequencies of facsimile transmitting stations programmed into this unit's ROM. This data is for reference purposes. Data is subject to change without notice.

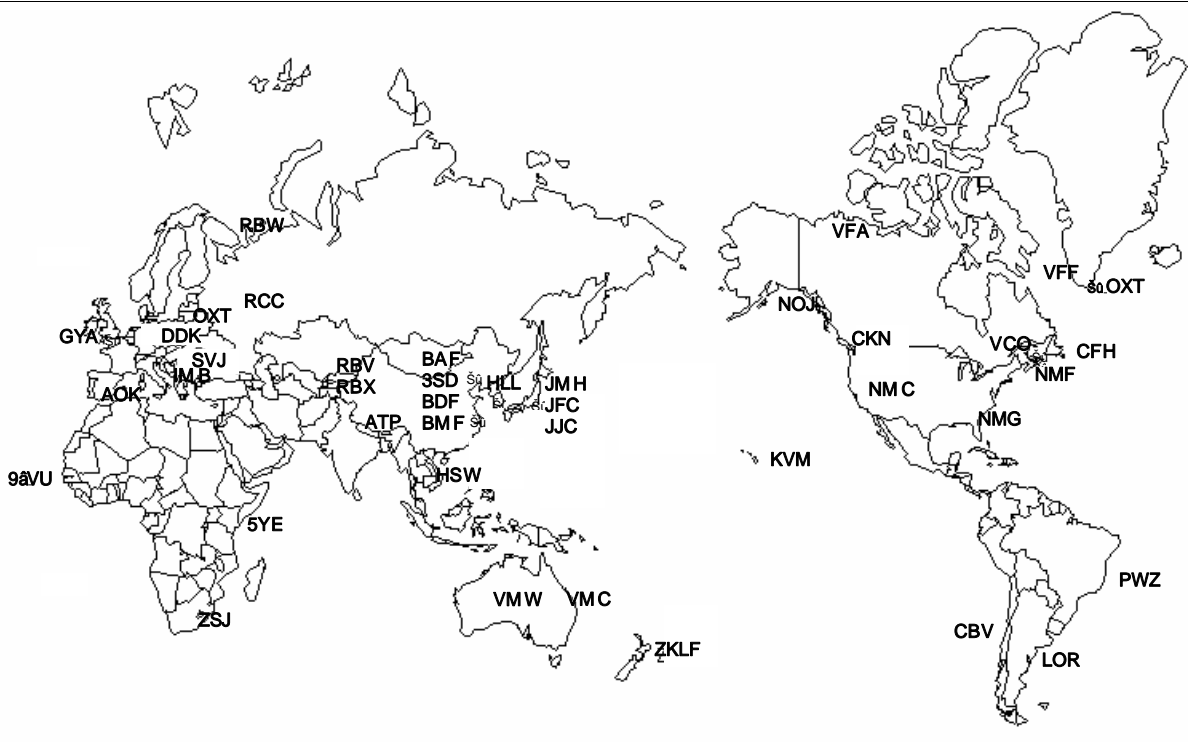

FACSIMILE STATION TABLE

CHANNEL NO.	CALL SIGN	STATION	FREQUENCY [kHz]	CHANNEL NO.	CALL SIGN	STATION	FREQUENCY [kHz]
000	JMH	JAPAN	3622.5	050	3SD	BEIJING	8461.9
001	JMH	JAPAN	7795.0	051	3SD	BEIJING	12831.9
002	JMH	JAPAN	13988.5	052	3SD	BEIJING	16903.9
010	JJC	MALAYSIA	8467.5	060	BDF	SHANGHAI	3241.0
011	JJC	MALAYSIA	12745.5	061	BDF	SHANGHAI	5100.0
012	JJC	MALAYSIA	16971.0	062	BDF	SHANGHAI	7420.0
013	JJC	MALAYSIA	17069.6	063	BDF	SHANGHAI	11420.0
014	JJC	MALAYSIA	22542.0	064	BDF	SHANGHAI	18940.0
015	JJC	MALAYSIA	17430.0				
020	JFC	JAPAN	4274.0	070	BMF	TAIPAI	4616.0
021	JFC	JAPAN	6414.5	071	BMF	TAIPAI	5250.0
022	JFC	JAPAN	8658.0	072	BMF	TAIPAI	8140.0
023	JFC	JAPAN	13074.0	073	BMF	TAIPAI	13900.0
024	JFC	JAPAN	16907.5	074	BMF	TAIPAI	18560.0
030	HLL	SEOUL	5385.0	080	ZKLF	AUCKLAND	3247.4
031	HLL	SEOUL	5857.5	081	ZKLF	AUCKLAND	5807.0
032	HLL	SEOUL	7433.5	082	ZKLF	AUCKLAND	9459.0
033	HLL	SEOUL	9165.0	083	ZKLF	AUCKLAND	13550.5
034	HLL	SEOUL	13570.0	084	ZKLF	AUCKLAND	16340.1
040	BAF	BEIJING	5526.9	090	VMC	CHARLEVILLE	2628.0
041	BAF	BEIJING	8121.9	091	VMC	CHARLEVILLE	5100.0
042	BAF	BEIJING	10116.9	092	VMC	CHARLEVILLE	11030.0
043	BAF	BEIJING	14366.9	093	VMC	CHARLEVILLE	13920.0
044	BAF	BEIJING	16025.9	094	VMC	CHARLEVILLE	20469.0
045	BAF	BEIJING	18236.9				

CHANNEL NO.	CALL SIGN	STATION	FREQUENCY [kHz]	CHANNEL NO.	CALL SIGN	STATION	FREQUENCY [kHz]
100	VMW	WILUNA	5755.0	180	6VU	DAKAR	4790.5
101	VMW	WILUNA	7535.0	181	6VU	DAKAR	13667.5
102	VMW	WILUNA	10555.0	182	6VU	DAKAR	19750.0
103	VMW	WILUNA	15615.0				
104	VMW	WILUNA	18060.0	190	LOR	PUERTO BELGRANO	5705.0
110	VLM	CASEY	7470.0	191	LOR	PUERTO BELGRANO	12672.0
120	KVM	HONOLULU	9982.5	200	PWZ	RIO DE-JANEIRO	12665.0
121	KVM	HONOLULU	11090.0	201	PWZ	RIO DE-JANEIRO	16978.0
122	KVM	HONOLULU	16135.0	210	CBV	VALPARAISO	4228.0
123	KVM	HONOLULU	23331.5	211	CBV	VALPARAISO	8677.0
130	HSW	BANGKOK	7396.8	212	CBV	VALPARAISO	17146.4
131	HSW	BANGKOK	17520.0	220	NMG	NEW ORLEANS	4317.9
140	ATP	NEW DELHI	7404.9	221	NMG	NEW ORLEANS	8503.9
141	ATP	NEW DELHI	14842.0	222	NMG	NEW ORLEANS	12789.9
150	GYA	PERSIAN GULF	3289.5	223	NMG	NEW ORLEANS	17146.4
151	GYA	PERSIAN GULF	6834.0	230	NMF	BOSTON	4235.0
152	GYA	PERSIAN GULF	14436.0	231	NMF	BOSTON	6340.5
153	GYA	PERSIAN GULF	18261.0	232	NMF	BOSTON	9110.0
160	5YE	NAIROBI	9044.9	233	NMF	BOSTON	12750.0
161	5YE	NAIROBI	17447.5	240	CFH	HALIFAX	4271.0
170	ZSJ	CAPE NAVAL	4014.0	241	CFH	HALIFAX	6496.4
171	ZSJ	CAPE NAVAL	7508.0	242	CFH	HALIFAX	10536.0
172	ZSJ	CAPE NAVAL	13538.0	243	CFH	HALIFAX	13510.0
173	ZSJ	CAPE NAVAL	18238.0				

FACSIMILE STATION TABLES

CHANNEL NO.	CALL SIGN	STATION	FREQUENCY [kHz]	CHANNEL NO.	CALL SIGN	STATION	FREQUENCY [kHz]
250	VFF	IQUALUT & RESOLUTE	3253.0	340	RBV	TASHKENT	3690.0
251	VFF	IQUALUT & RESOLUTE	7710.0	341	RPJ	TASHKENT	4365.0
260	VCO	SYDNEY,NOVA SCOTIA	4416.0	342	RBV	TASHKENT	5890.0
261	VCO	SYDNEY,NOVA SCOTIA	6915.0	343	RBX	TASHKENT	7570.0
270	VFA	INUVIK	8457.8	344	RCH	TASHKENT	9340.0
280	XL17	AIRBORNE ICE T.	4616.0	345	RBV	TASHKENT	14982.5
281	XL17	AIRBORNE ICE T.	6915.1	350	RBX	TASHKENT2	3280.0
282	XL17	AIRBORNE ICE T.	7708.1	351	RBX	TASHKENT2	5285.0
290		COST GUARD ICE B.	14770.0	352	RLJ	TASHKENT2	8083.0
300	NOJ	KODIAK	2054.0	353	RCH	TASHKENT2	9190.0
301	NOJ	KODIAK	4298.0	354	ROM	TASHKENT2	13947.0
302	NOJ	KODIAK	8459.0	360	RBW	MURMANSK	5336.0
303	NOJ	KODIAK	12412.5	361	RBW	MURMANSK	6445.5
310	NMC	PT.REYES	4346.0	362	RBW	MURMANSK	7908.8
311	NMC	PT.REYES	8682.0	363	RBW	MURMANSK	10130.0
312	NMC	PT.REYES	12786.0	370	GYA	NORTHWOOD	2618.5
313	NMC	PT.REYES	17151.2	371	GYA	NORTHWOOD	4610.0
314	NMC	PT.REYES	22527.0	372	GYA	NORTHWOOD	8040.0
320	IMB	ROMA	4777.5	373	GYA	NORTHWOOD	11086.5
321	IMB	ROMA	8146.6	380	DDH	HAMBURG	3855.0
322	IMB	ROMA	13597.4	381	DDK	HAMBURG	7880.0
330	SVJ	ATHENS	4481.0	382	DDK	HAMBURG	13882.5
331	SVJ	ATHENS	8105.0	390	OXT	SKAMLEBAEK	5850.0
				391	OXT	SKAMLEBAEK	9360.0
				392	OXT	SKAMLEBAEK	13855.0
				393	OXT	SKAMLEBAEK	17510.0

**SPECIFICATIONS OF FACSIMILE RECEIVER
FAX-408****1 RECEIVER**

1.1	Reception	Synthesized double superheterodyne
1.2	Frequency range	MF/HF 2.0000 – 24.99999 MHz
1.3	Mode	F3C
1.4	Selectivity	2.0 kHz at -6 dB
1.5	Number of channels	314 channels (150 pre-set channels, 164 user channels)
1.6	Sensitivity	MF/HF 2 μ V at 20 dB SINAD
1.7	Channel selection	Automatic or manual, with numeric keys
1.8	Tuning indicator	3 LEDs
1.9	Display	LCD, 32 characters in 2 lines
1.10	External signal input	1500 Hz (black) and 2300 Hz (white), FSK or FM signal

2 RECORDER

2.1	Recording system	Electronic scanning w/thermal head
2.2	IOC	Index of Cooperation, 576 and 288
2.3	Recording speed	60, 90, 120 scans per minute
2.4	Gradation	9 tones (white, 7 gray levels and black)
2.5	Recording paper	Thermal paper (216 mm \times 20 m)
2.6	Line density	8 dots/mm (total number of dots: 1696)

3 AUTOMATIC RECORDING CONTROL

3.1	Start/stop	Automatic start or stop by timer program and/or WMO Standard, remote control signal (or manual)
3.2	Recording rate	Automatic selection of recording rate (or manual)
3.3	IOC	Automatic selection of IOC by WMO start signal (or manual)
3.4	Phase	Automatic selection of phase matching by passing signal (or manual)

4 POWER

4.1	Power source	12-24 VDC: 2.3 – 1.15 A
-----	--------------	-------------------------

5 ENVIRONMENTAL CONDITIONS

5.1	Temperature	-10°C to +50°C
5.2	Humidity	95% relative humidity (35°C)
5.3	Waterproofing (IEC60529)	IPX0
5.4	Vibration	3 mm/480 rpm - 0.2 mm/3000 rpm

6 COATING COLOR

6.1 Main unit N2.5

7 PREAMP UNIT FAX-5 (option)

7.1 Frequency range 80 kHz – 30 MHz

7.2 Antenna Wire antenna or 2.6 m whip antenna

7.3 Input protection Withstand a 30 Vrms antenna input for 15 minutes



7.4 Output impedance 50 ohms

7.5 Power 9 VDC, fed from facsimile receiver via coaxial cable

PACKING LIST FAX-408-J/E

08AY-X-9851-1

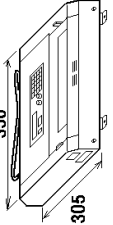
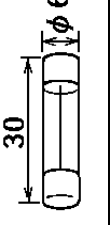
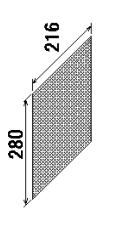
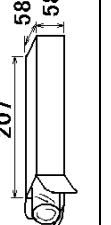
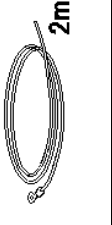
1/1

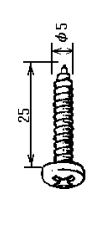
NAME	OUTLINE	DESCRIPTION/CODE	Q'TY
ユニット			
ファクシミリ受画装置 FACSIMILE RECEIVER		FAX-408* 000-010-130-00 ****	1
予備品			
SPARE PARTS			
ヒューズ FUSE		FGBO 125V 7A PBF 000-155-831-10	2
付属品			
ACCESSORIES			
ヘッドクリーニングシート HEAD CLEANING SHEET		F081267 (#2000) 000-164-342-10	1
サマシ紙 THERMAL PAPER		TP-0820B 000-157-755-10	1
工事材料			
INSTALLATION MATERIALS			
アース線 (DC) GROUNDING WIRE (DC)		343200602 000-161-860-00	1
コネクタ (M) CONNECTOR		M-P-7 FMP-1C 000-500-512-00	1
+self タッピングネジ SELF-TAPPING SCREW		5X25 SUS304 1ｼｼ 000-867-553-00	4

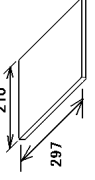
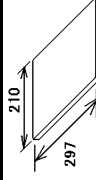
NAME	OUTLINE	DESCRIPTION/CODE	Q'TY
小型丸平座金 FLAT WASHER		M6 SUS304 000-864-029-00	5
図書			
DOCUMENT			
取扱説明書 OPERATOR'S MANUAL		OM*-62620-*	1
操作要領書 (多言語) OPERATOR'S GUIDE (MLG)		000-161-607-0* ** MLG-62620-*	1

コード番号末尾の[*]**は、選択品の代表コードを表します。

CODE NUMBER ENDING WITH "****" INDICATES THE CODE NUMBER OF REPRESENTATIVE MATERIAL.

(略図の寸法は、参考値です。DIMENSIONS IN DRAWING FOR REFERENCE ONLY.)

型式/コード番号が2段の場合、下段より上段に代わる過渡期品であり、どちらが入っています。なお、品質は変わりません。

TWO TYPES AND CODES MAY BE LISTED FOR AN ITEM. THE LOWER PRODUCT MAY BE SHIPPED IN PLACE OF THE UPPER PRODUCT. QUALITY IS THE SAME.

A-1

08AY-X-9851

表1 TABLE 1

寸法区分(mm) DIMENSIONS	公差(mm) TOLERANCE
$0 < L \leq 50$	± 1.5
$50 < L \leq 100$	± 2.5
$100 < L \leq 500$	± 3

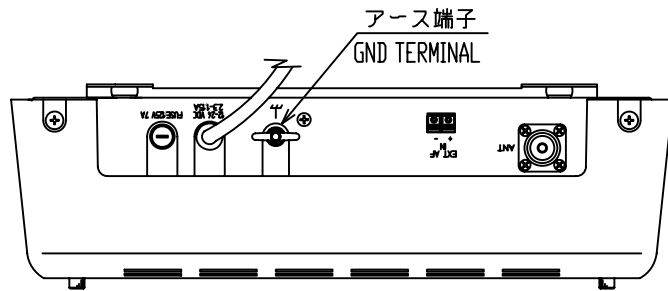

A

B

 警告ラベル
WARNING LABEL

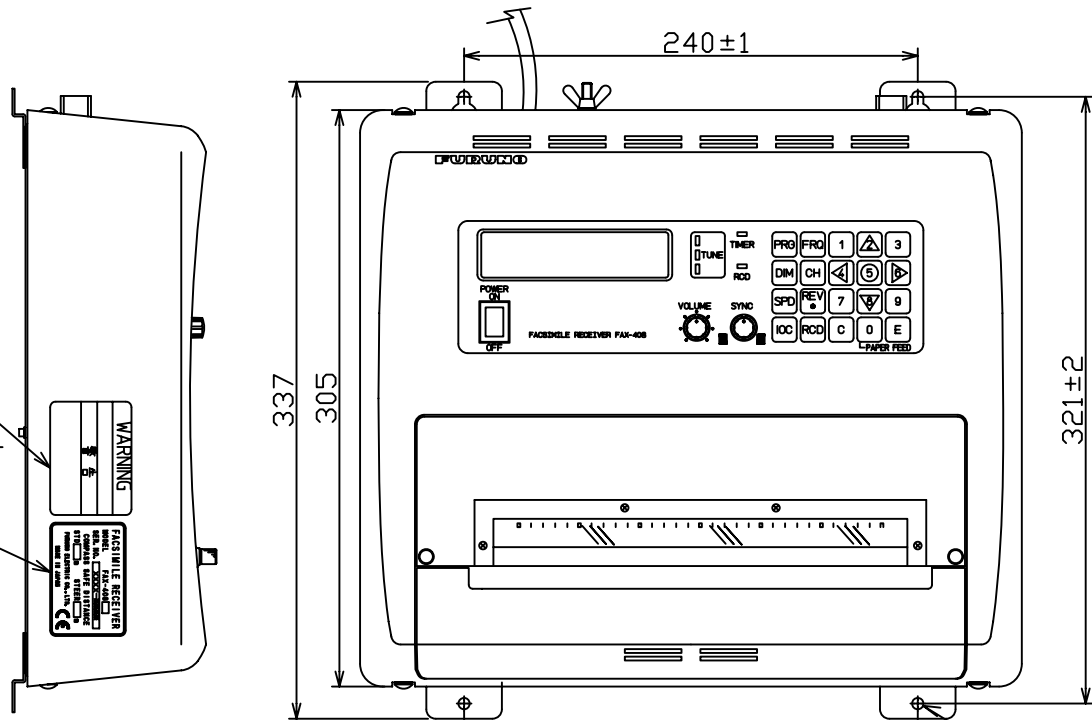
 銘板
NAMEPLATE

C

D

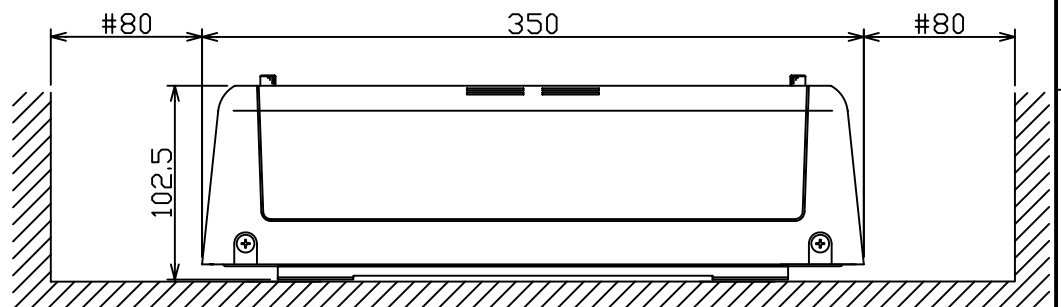

注記

- 1) 指定なき寸法公差は表1による。
- 2) #印寸法は最小サービス空間寸法とする。

NOTE

1. TABLE 1 INDICATES TOLERANCE OF DIMENSIONS WHICH IS NOT SPECIFIED.
2. #: MINIMUM SERVICE CLEARANCE.

DRAWN	Nov. 24, '06 E. MIYOSHI	TITLE	FAX-408
CHECKED	TAKAHASHI, T	名称	ファクシミリ受画装置
APPROVED	Y.Hatai		外寸図
SCALE	1/4	質量	5.6 ±10% kg
DWG.No.	C6262-G01-B	質量は記録紙を含まない。 MASS DOES NOT INCLUDE RECORDING PAPER.	NAME
	REF.No.	031373	FACSIMILE RECEIVER
			OUTLINE DRAWING

表 1 TABLE 1

寸法範囲 (mm) DIMENSIONS	公差(mm) TOLERANCE
$L \leq 50$	± 1.5
$50 < L \leq 100$	± 2.5
$100 < L \leq 500$	± 3

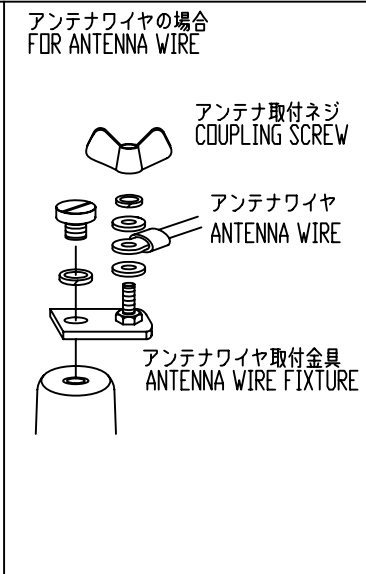
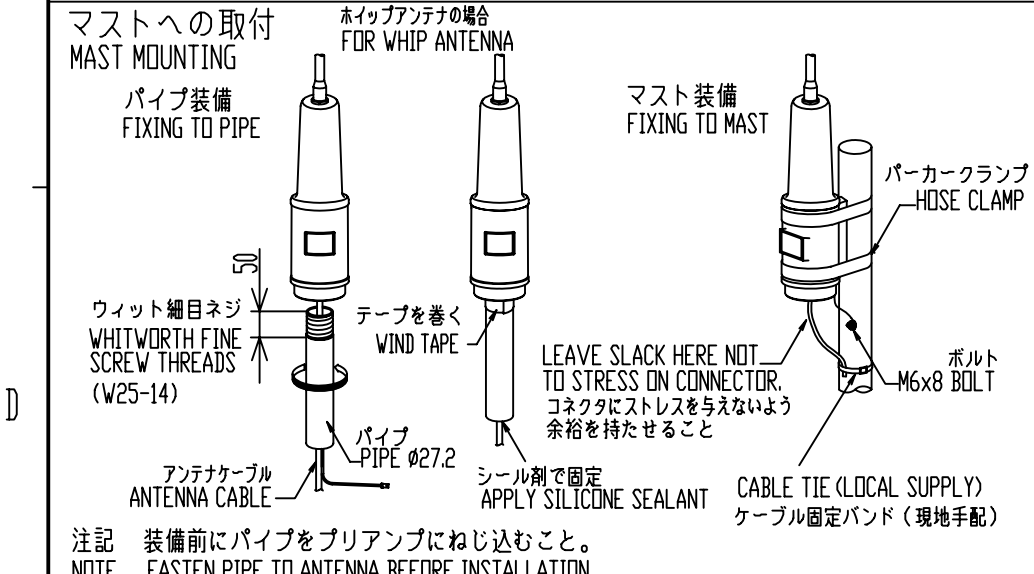
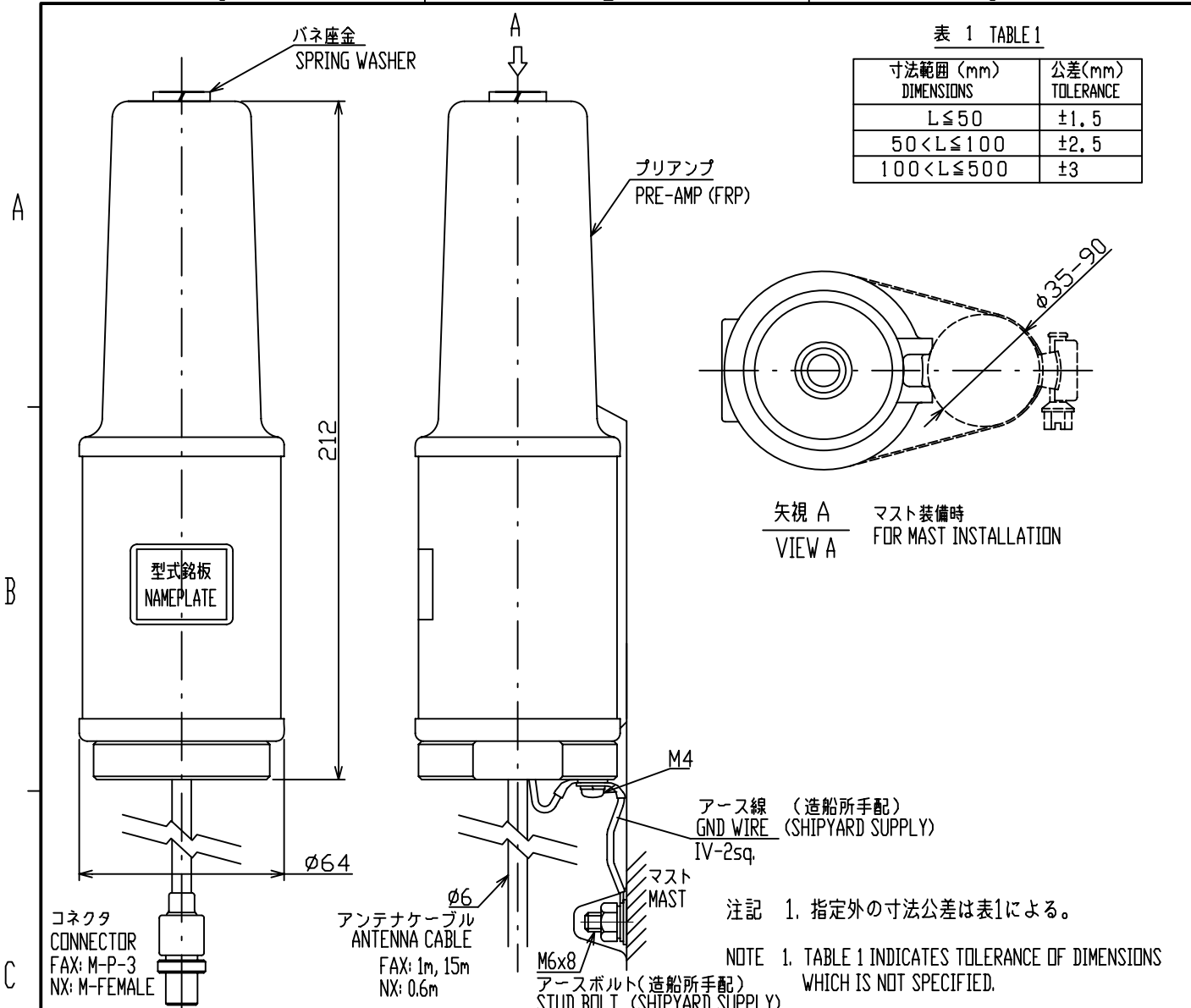

DRAWN Nov. 20, '06 E. MIYOSHI	TITLE FAX-5, NX-5/6
CHECKED TAKAHASHI, T	名称 プリアンプ
APPROVED Y. Hatai	外寸図
SCALE 1/2 MASS 0.6 ±10% kg	NAME PRE-AMP UNIT
DWG.No. C6244-003-N	OUTLINE DRAWING

質量はケーブルを含まず。質量 W/D CABLE.

REF.No.

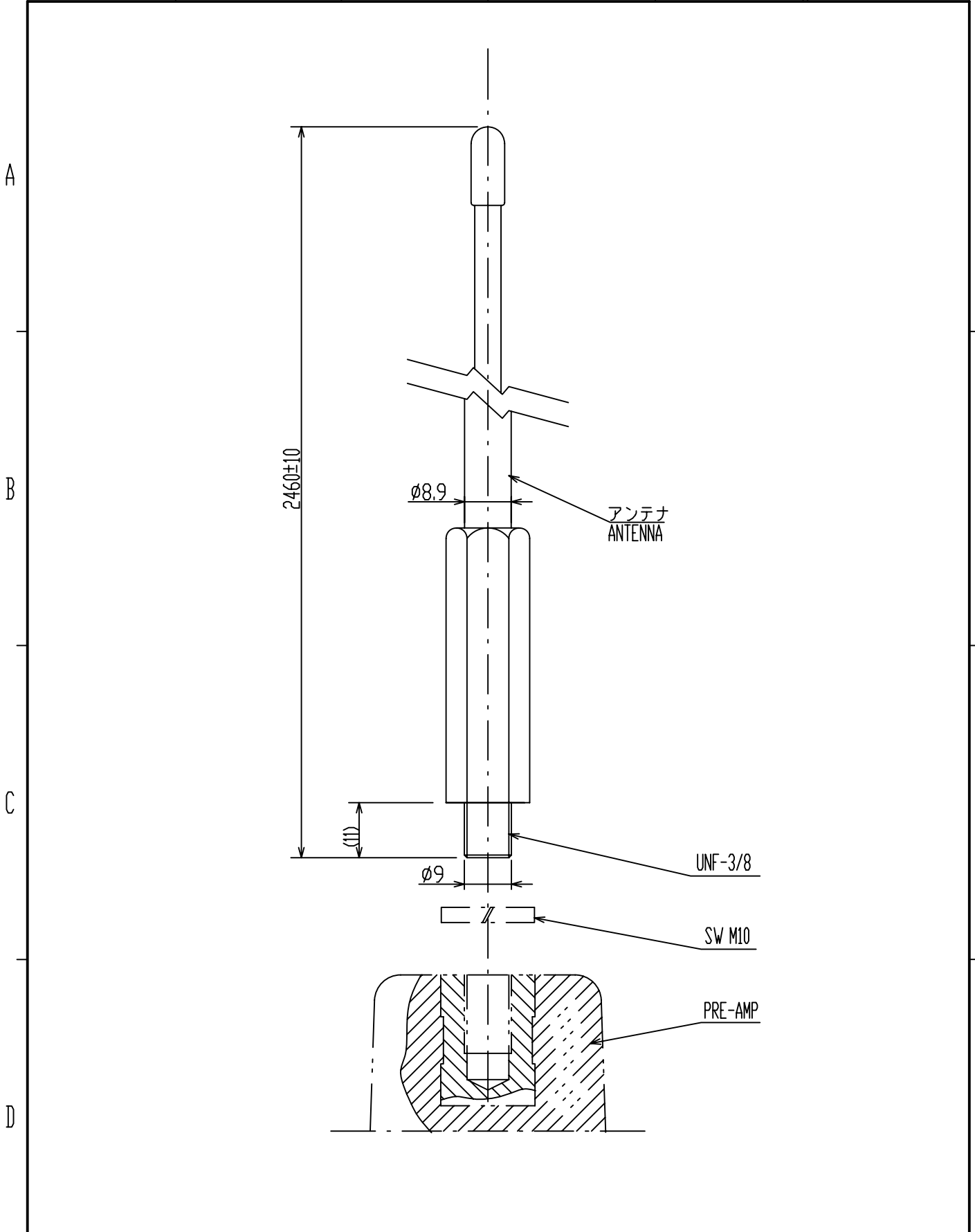

DRAWN Nov. 25, '06	E. MIYOSHI	TITLE	04S4176-2
CHECKED	TAKAHASHI, T	名称	2.6m ホイップアンテナ
APPROVED	Y. Hatai		外寸図
SCALE 1/1	MASS 0.5 kg	NAME	2.6m WHIP ANTENNA
DWG.No. C4002-018-H	REF.No.		OUTLINE DRAWING

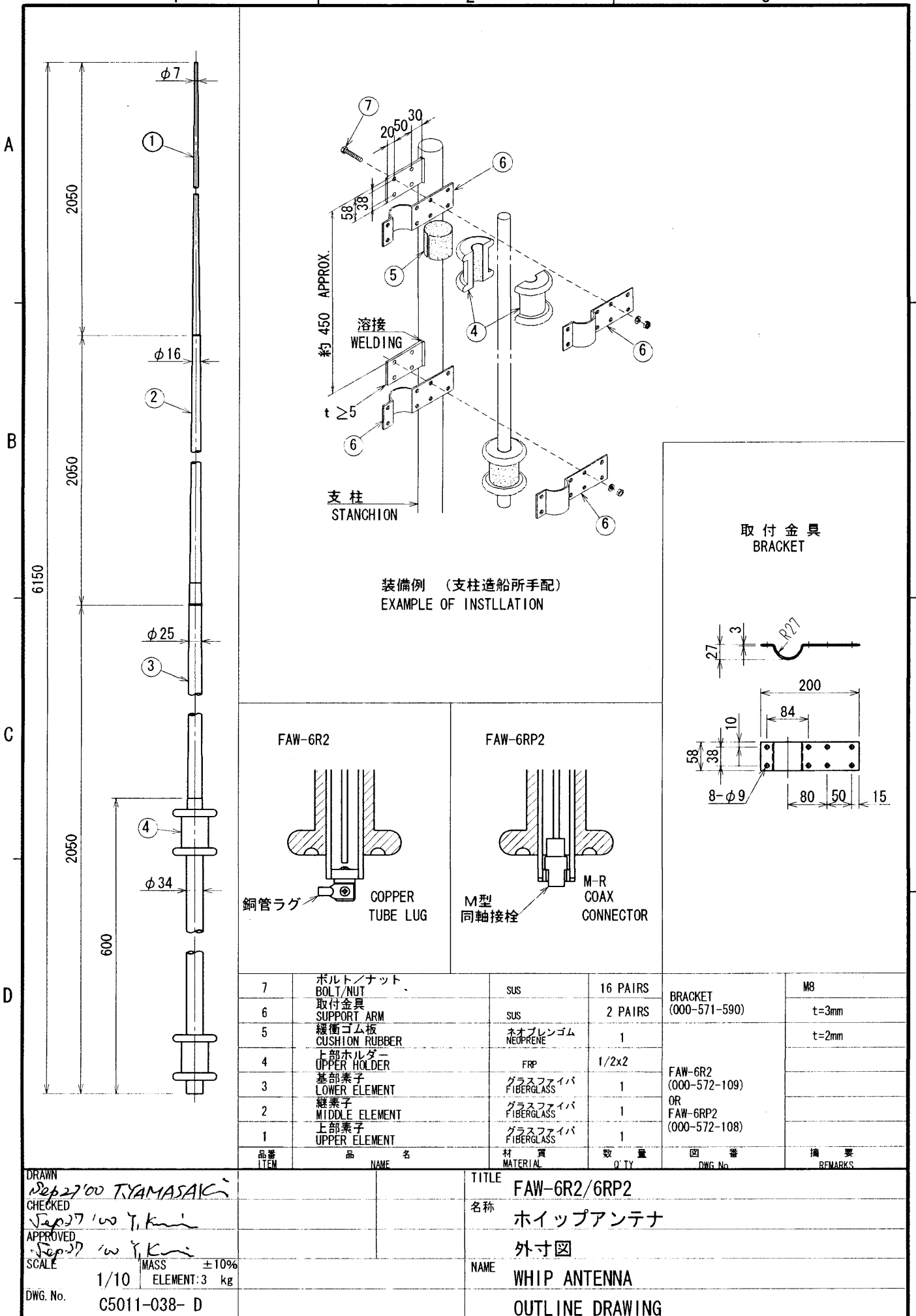

約 450 APPROX.

溶接
WELDING

支柱
STANCHION

装備例 (支柱造船所手配)
EXAMPLE OF INSTLLATION

取付金具
BRACKET

FAW-6R2

FAW-6RP2

銅管ラグ
COPPER
TUBE LUG

M型
同軸接栓
M-R
COAX
CONNECTOR

7	ボルト/ナット BOLT/NUT	SUS	16 PAIRS	BRACKET (000-571-590)	M8
6	取付金具 SUPPORT ARM	SUS	2 PAIRS		t=3mm
5	緩衝ゴム板 CUSHION RUBBER	ネオプレンゴム NEOPRENE	1	FAW-6R2 (000-572-109) OR FAW-6RP2 (000-572-108)	t=2mm
4	上部ホルダー UPPER HOLDER	FRP	1/2x2		
3	基部素子 LOWER ELEMENT	グラスファイバ FIBERGLASS	1		
2	継素子 MIDDLE ELEMENT	グラスファイバ FIBERGLASS	1		
1	上部素子 UPPER ELEMENT	グラスファイバ FIBERGLASS	1		
品番 ITEM	品名 NAME	材質 MATERIAL	数量 QTY	図番 DWG No	摘要 REMARKS

DRAWN
2006.27.00 TYAMASAKI
CHECKED
2007.10.00 Y. Kuni
APPROVED
2007.10.00 Y. Kuni
SCALE 1/10 MASS ±10%
ELEMENT: 3 kg
DWG. No. C5011-038- D

TITLE
名称 FAW-6R2/6RP2
ホイップアンテナ
外寸図
NAME
WHIP ANTENNA
OUTLINE DRAWING

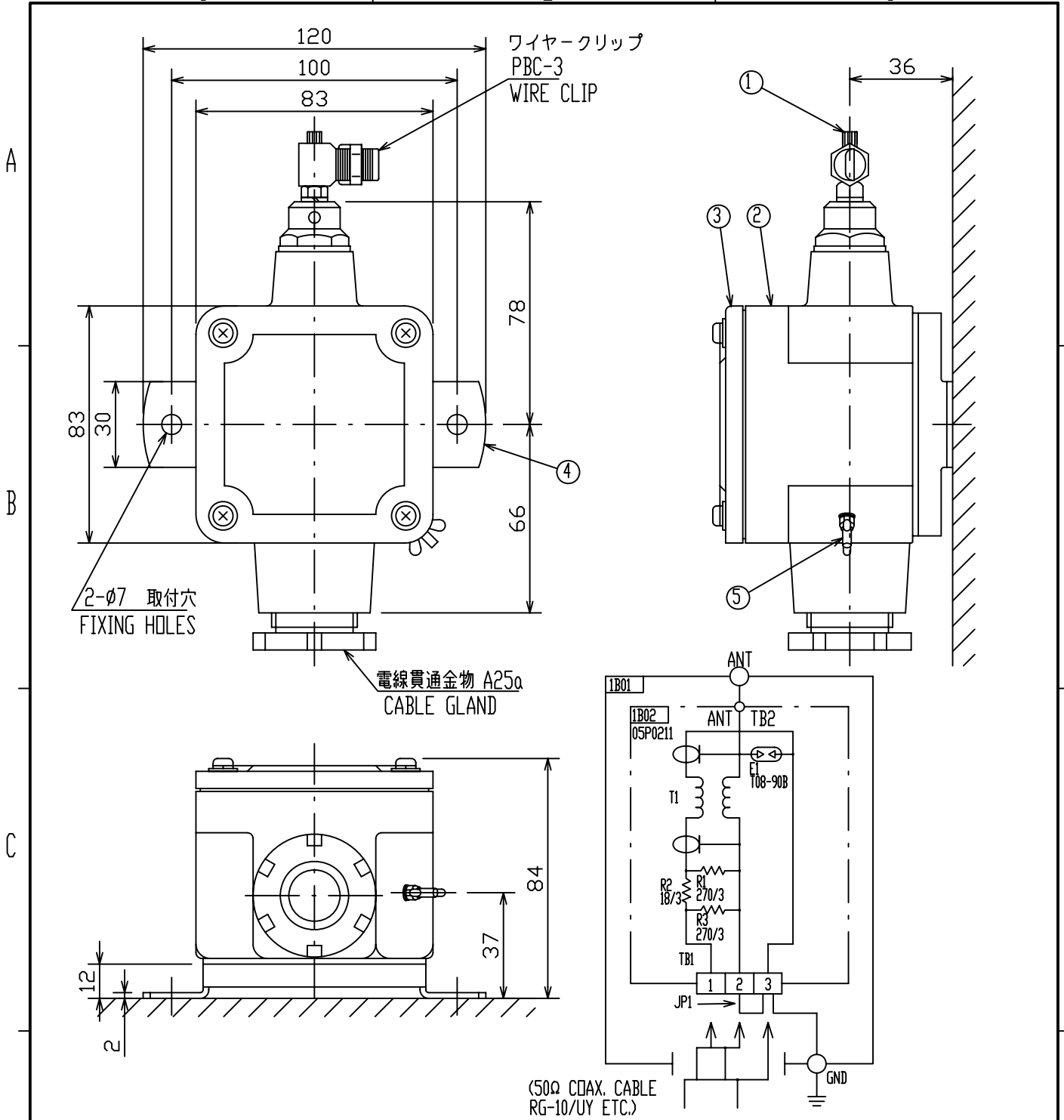

注記：アース端子を船体に接地したときはJP1の切断可。
 NOTE: JPI MAY BE REMOVED IF GND STUD IS GROUNDED TO SHIP'S BODY.

品番 ITEM	品名 NAME	材質 MATERIAL	数量 Q'TY	図番 DWG. NO.	備註 REMARKS
5	アース端子 EARTH TERMINAL	SUS304BD	1		
4	取付足 FIXING PLATE	SUS304	1		
3	カバー COVER	SUS304	1		
2	本体 BODY	FRP(DMC)	1		
1	アンテナ端子 ANT TERMINAL	SUS303B	1		

DRAWN	Jul. 6 '06 T.YAMASAKI	TITLE	ARD-1
CHECKED	Jul. 6 '06 T.TAKENO	名称	空中線接続箱
APPROVED	Jul. 07 '06 T.Matsuguchi		外寸図
SCALE	1/2 MASS 0.7 $\pm 10\%$ kg	NAME	MATCHING BOX
DWG.No.	C5017-064-G		OUTLINE DRAWING

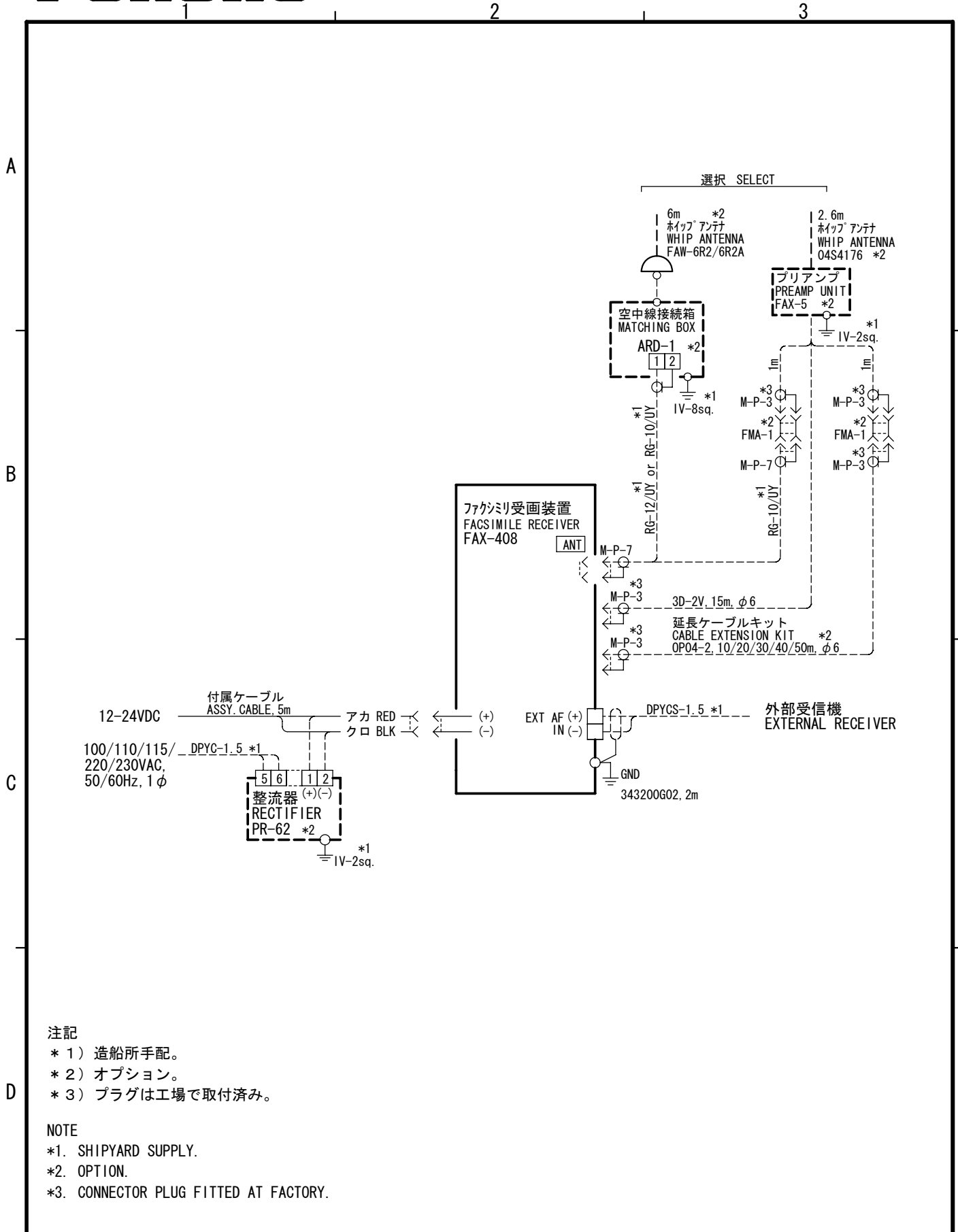

DRAWN Aug. 16 '06 Maki	TITLE FAX-408
CHECKED TAKAHASHI. T	名称 ファクシミリ受画装置
APPROVED Hatai	相互結線図
SCALE MASS kg	NAME FACSIMILE RECEIVER
DWG. No. C6262-C01- B	REF. No. INTERCONNECTION DIAGRAM